

2022  
**REPUESTOS**  
DENTALES

2ª Edición

Bienvenido



# RUMAR

mayorista dental

2004 – 2022

## 18 AÑOS A SU SERVICIO

Mayorista dental en España y Portugal con venta exclusiva a Depósitos Dentales y Servicios Técnicos.



### ¿A qué nos dedicamos?

En RUMAR nos dedicamos desde el año 2004 a la importación de repuestos dentales y aparatología dental, y la distribución de repuestos, aparatología e instrumental médico odontológico exclusivamente a depósitos dentales y servicios técnicos.

“Buenos precios. Gran selección. Servicio rápido.”

### Definiciones previas

**Nuestro equipo:** profesionales al servicio de nuestros socios.

**Nuestros socios:** conjunto de servicios técnicos y depósitos que confían en nosotros. Ellos son la razón de nuestro existir.

**Un buen día:** haber atendido satisfactoriamente las necesidades de nuestros socios.

### Historia

**2004:** La semilla de nuestro proyecto es plantada por Margarita Crespo y Wolfgang Ade en Cedeira – A Coruña.

**2012:** Una nueva generación liderada por Alejandro Tuimil toma el relevo de la empresa y se traslada a Collado Villalba – Madrid.

**2018:** Se inauguran las nuevas instalaciones en Alpedrete – Madrid, con más de 320 m<sup>2</sup> al servicio de nuestros socios.

### Nuestro día a día

Somos un equipo de jóvenes profesionales dedicados a garantizar el mejor servicio y asesoramiento a nuestros socios.

Simplemente dedicamos nuestro día a día a hacer que el día a día de nuestros socios (depósitos dentales y servicios técnicos) sea más fácil, y convertirnos así en su aliado clave y nunca su competidor.

Parte del equipo RUMAR está dedicado constantemente a complementar nuestro stock y a hacer posible que mañana podamos atender las necesidades de nuestros socios mejor y más rápidamente.

El resto del equipo está dedicado a que hoy por hoy nuestros socios reciban lo que necesitan, cuándo y cómo lo necesitan.

# ▶ RECOMENDACIÓN PARA SUS BÚSQUEDAS

## Estimados Clientes,

Muchas gracias por su interés en nuestros productos.

En RUMAR contamos con más de 1.400 referencias entre todos nuestros productos y repuestos, por lo que en ocasiones puede complicarse la búsqueda de un determinado producto o repuesto. Para esas ocasiones, he aquí algunas recomendaciones útiles.

**1.** Como podrá apreciar, nuestros catálogos y listas de precios están generados en formato PDF (Adobe Acrobat). Este formato le permite utilizar un buscador automático que le facilitará su búsqueda. Para ello solamente debe seguir los siguientes pasos:

**a.** Abra nuestro catálogo o lista de precios de “Aparatología y Cirugía” o de “Repuestos” en función de la naturaleza de la referencia de su interés.

**b.** En la barra de herramientas en la cabecera de su pantalla es probable que encuentre una caja de texto de color blanco, con la palabra “Find” o “Buscar” en gris claro.

**c.** Como alternativa al paso “b” y si no encuentra el cuadro de texto en cuestión, diríjase al menú de “Tools” o “Herramientas” en la cabecera del documento. Aquí encontrará la opción: “Customize Toolbar” o “Personalizar barra de herramientas”. Tras pinchar en esta opción, se abrirá un nuevo menú donde podrá marcar las opciones que desea visualizar en su pantalla. Seleccione la opción “Find Toolbar” o “Barra de Búsqueda”. Tras esta operación deberá aparecer en su pantalla una caja de texto de color blanco, con la palabra “Find” o “Buscar” en gris claro.

**d.** Pinche en esta caja y escriba la referencia (RUMAR) del producto o repuesto de su interés o una palabra clave relacionada. Ejemplo: si Usted está interesado en unas escobillas para el K9, pruebe escribiendo escobilla o K9, y presione intro.

**2.** Esta búsqueda le posicionará en el primer lugar de todo el catálogo o la lista donde aparezca esta referencia o palabra. Si no es lo que Usted busca, vuelva a pulsar intro, y le llevará al siguiente lugar donde aparezca esta referencia o palabra. Repita estos pasos hasta que aparezca en pantalla lo que busca o hasta determinar que no contamos con ese producto o repuesto. En este último caso, consúltenos.

En caso de que los pasos 1 y 2 no sean fructíferos, a continuación le ofrecemos una segunda alternativa.

**3.** Diríjase al índice de nuestro catálogo. En él podrá encontrar de forma esquemática grupos y subgrupos de productos que le pueden ayudar en su búsqueda.

**4.** Tras ubicar el grupo o subgrupo al que pertenezca el producto o repuesto de su interés, diríjase a la página indicada y realice la búsqueda.

**Recuerde que siempre cuenta con la alternativa de contactar con nosotros e:**

- **email:** [rumarcedeira@rumarcedeira.com](mailto:rumarcedeira@rumarcedeira.com)

- **Teléfono:** 918 49 01 04

---

## ¿Cómo reconocer en el nuevo catálogo las novedades, bajadas de precio, referencias bajo pedido...?

▶ **Novedad**

▶ **Bajada de precio**

**BAJO PEDIDO**

**HASTA AGOTAR**

---

Nuevamente **gracias por su interés** en nuestros productos, y mucha suerte con su búsqueda y su negocio.



**Siempre en Stock**  
**Entrega en 24 horas**



▶ **Pedidos**

**Teléfono:** 918 49 01 04  
**e-mail:** pedidos@rumarcedeira.com



▶ **Att. al Cliente**

**Teléfono:** 918 49 01 04 / 626 327 863  
**e-mail:** rumarcedeira@rumarcedeira.com



[www.rumarcedeira.com](http://www.rumarcedeira.com)





# ÍNDICE

	pág.	Subíndice
<b>RR</b> ▶ <b>REPUESTOS ROTATORIO</b> .....	<b>9 - 104</b>	<b>8</b>
<b>Alta Velocidad</b> (Turbinas y acoplamientos):		
<ul style="list-style-type: none"><li>- Rotores turbina dental</li><li>- Rotores turbina laboratorio</li><li>- Rodamientos turbinas</li><li>- Tapas botón turbinas</li><li>- Tapas, difusores, toberas y tornillos spray</li><li>- Otros repuestos turbinas</li><li>- Juntas conexión turbinas, acoplamientos, micromotores</li><li>- LEDs y bombillas Xenon turbinas y acoplamientos</li><li>- Anillos tóricos y arandelas turbinas y acoplamientos</li><li>- Repuestos acoplamientos</li></ul>		
<b>Baja Velocidad</b> (contra ángulos, piezas de mano, micromotores):		
<ul style="list-style-type: none"><li>- Rodamientos contra-ángulos, piezas de mano y micromotores clínica</li><li>- Repuestos cabezas, contra ángulos, piezas de mano, micromotores neumáticos, acoplamientos</li><li>- Anillos tóricos contra ángulos, piezas de mano, micromotores y ultrasonidos</li><li>- Rodamientos micromotores eléctricos</li><li>- Rotores, escobillas, pinzas y otros repuestos micromotores eléctricos</li></ul>		
<b>RLF</b> ▶ <b>REPUESTOS LÁMPARAS FARO</b> .....	<b>106-109</b>	<b>105</b>
<ul style="list-style-type: none"><li>- Repuestos lámpara Alya</li><li>- Repuestos lámpara Maia</li><li>- Repuestos lámpara EDI</li><li>- Repuestos lámpara Forma y otras</li></ul>		
<b>RAS</b> ▶ <b>REPUESTOS AUTOCLAVES Y SELLADORAS</b> .....	<b>111</b>	<b>110</b>
<b>JRJ</b> ▶ <b>JERINGAS Y REPUESTOS JERINGAS</b> .....	<b>113-125</b>	<b>112</b>
<ul style="list-style-type: none"><li>- Jeringas Luzzani y sus repuestos</li><li>- Jeringas FARO y sus repuestos</li><li>- Jeringas económicas</li></ul>		
<b>ME</b> ▶ <b>MANGUERAS EQUIPOS</b> .....	<b>127-144</b>	<b>126</b>
<ul style="list-style-type: none"><li>- Mangueras turbinas con y sin conector a equipo</li><li>- Mangueras ultrasonidos con y sin conector a equipo</li><li>- Mangueras micromotores con y sin conector a equipo</li><li>- Accesorios mangueras</li><li>- Mangueras jeringas con y sin conector a equipo</li><li>- Mangueras pedales</li></ul>		
<b>RV</b> ▶ <b>REPUESTOS VARIOS</b> .....	<b>146-162</b>	<b>145</b>
<ul style="list-style-type: none"><li>- Repuestos Micron scaler SSS</li><li>- Repuestos pulidor bicarbonato Micron Quick Jet</li><li>- Repuestos lámparas quirófano Derungs</li><li>- Repuestos Nouvag</li><li>- Repuestos taburetes Jörg &amp; Sohn</li><li>- Repuestos Woodpecker y DTE</li><li>- Repuestos taburetes Pluto</li><li>- Repuestos equipo mural €coLine</li><li>- Lámpara polimerizar para unidad</li><li>- Repuestos lámparas polimerizar</li><li>- Piezas de mano y kits "Built in" ultrasonidos</li><li>- Kits "Built in" TKD micromotores eléctricos</li><li>- Micromotores eléctricos reciclados</li></ul>		

	pág.	Subíndice
<b>RCD</b>	<b>▶ REPUESTOS COMPRESORES DÜRR DENTAL .....</b>	<b>164-165      163</b>
<b>SAR</b>	<b>▶ SISTEMAS DE ASPIRACIÓN Y REPUESTOS .....</b>	<b>167-193      166</b>
	<ul style="list-style-type: none"> <li>- Motores aspiración Luzzani Dental y repuestos</li> <li>- Motores aspiración, centrifugadoras y separadores de amalgama METASYS</li> <li>- Válvulas y accesorios METASYS</li> <li>- Repuestos aspiraciones METASYS</li> <li>- Conectores META connect (METASYS)</li> <li>- Motores aspiración, centrifugadoras y separadores de amalgama Dürr Dental</li> <li>- Repuestos aspiraciones Dürr Dental</li> <li>- Conectores Dürr connect</li> <li>- Soportes aspiración Luzzani Dental</li> <li>- Mangueras y tubos aspiración</li> <li>- Terminales de aspiración y adaptadores</li> </ul>	
<b>PR</b>	<b>▶ PEDALES Y SUS REPUESTOS .....</b>	<b>195-197      194</b>
<b>RCE</b>	<b>▶ RACORES, CONECTORES Y ESPIGAS .....</b>	<b>199-205      198</b>
	<ul style="list-style-type: none"> <li>- Racorería, conectores y llaves de paso</li> <li>- Espigas</li> <li>- Conectores de Nylon</li> </ul>	
<b>VE</b>	<b>▶ VÁLVULAS Y ELECTROVÁLVULAS.....</b>	<b>207-218      206</b>
	<ul style="list-style-type: none"> <li>- Válvulas (Faro, Clippard, RUMAR)</li> <li>- Electroválvulas (Sirai / ASCO NEUMATICS)</li> </ul>	
<b>RP</b>	<b>▶ REGULADORES DE PRESIÓN.....</b>	<b>220-221      219</b>
	<ul style="list-style-type: none"> <li>- Reguladores y accesorios</li> <li>- Repuestos depósito agua destilada</li> </ul>	
<b>H</b>	<b>▶ HERRAMIENTAS .....</b>	<b>223-236      222</b>
	<ul style="list-style-type: none"> <li>- Herramientas instrumental rotatorio</li> <li>- Herramientas equipos</li> </ul>	

## AVISO IMPORTANTE

RUMAR se enorgullece de ofrecer repuestos originales de marcas líderes en el sector dental como: Luzzani®, Faro®, Metasys®, Dürr®, myonic®, Sirai ®y ASCO pneumatics®, Clippard®, TKD®, Novag®, Micron®, Woodpecker®, DTE® y DCI.®

Y para el resto de marcas, RUMAR ofrece piezas de recambio compatibles de comprobada calidad.

La empresa y sus productos no tienen ninguna relación con las siguientes empresas y marcas: Kavo®, Bien Air®, NSK®, Chirana Medical®, EMS®, Satelec®, Mectron®, W&H®, Siemens®, Sirona®, Castellini®, B.A. International®, Fona ®, Planmeca®, Morita®, Saeshin®, Marathon®, Anthos®, Stern Weber®, Cefla®, Cattani®, Lares®.

- Nos reservamos el derecho de modificar precios y características técnicas sin previo aviso. Para cerciorarse de estos posibles cambios, recomendamos revisar la información de la referencia que busca en nuestra web.
- Con cualquier pedido se acepta expresamente nuestras condiciones generales de venta disponibles en nuestra WEB.

## ▶ REPUESTOS ROTATORIO

### **Alta Velocidad** (Turbinas y acoplamientos):

- Rotores turbina dental
- Rotores turbina laboratorio
- Rodamientos turbinas
- Tapas botón turbinas
- Tapas, difusores, toberas y tornillos spray
- Otros repuestos turbinas
- Juntas conexión turbinas, acoplamientos, micromotores
- LEDs y bombillas Xenon turbinas y acoplamientos
- Anillos tóricos y arandelas turbinas y acoplamientos
- Repuestos acoplamientos

### **Baja Velocidad** (contra ángulos, piezas de mano, micromotores):

- Rodamientos contra-ángulos, piezas de mano y micromotores clínica
- Repuestos cabezas, contra ángulos, piezas de mano, micromotores neumáticos, acoplamientos
- Anillos tóricos contra ángulos, piezas de mano, micromotores y ultrasonidos
- Rodamientos micromotores eléctricos
- Rotores, escobillas, pinzas y otros repuestos micromotores eléctricos





















# ROTORES RM para TURBINA

---





- **Rodamientos cerámicos myonic®**, con tolerancias ABEC7 como mínimo.
- Balanceados electrónicamente.
- **Pinza de Acero** endurecido y anticorrosión.
- **Inserto** de Carburo o Acero según modelo.
- **Recubrimiento de WCC** (Wolframcardid) para una mayor vida útil de la pinza y sus componentes.
- **Aspa de Aluminio** sin plomo.
- **Concentricidad** < 0,018mm /
- **Balaceo** < 0,05mg mm.
- **Fuerza de retención mínima** 42 N.
- **Suministro incluye:** anillos tóricos y arandelas metálicas (según modelo).

(\*\*)Debido a su no disponibilidad, los rotores con (\*\*) junto a la referencia son rotores que aunque de muy buena calidad no son del mismo fabricante y / o no cuentan con rodamientos myonic® como el resto de nuestros rotores rm. En nuestro afán por atender la demanda de nuestros clientes hemos incorporado estos modelos de fabricantes alternativos y a pesar de no contar con las mismas calidades, ofrecemos la **misma garantía: 12 meses sobre la pinza.**

Rotores compatibles turbinas KaVo®





	Modelos para KaVo®	Relacionados
 myonic	 <p>606B, 606C 625B, 625C SUPERtorque® 630B</p> <p>SUPERtorque® 630C SUPERtorque® 640B SUPERtorque® 640C</p> <p><b>Ref.: 34-2106</b> (Ref. KaVo: 0.553.5881)</p>	<p>Tapa Ref.: 44-6511 para 640 Tapa Ref.: 49-830 para 630 Llave Ref. : 30-609</p> <p><b>144<sup>80</sup>€</b></p>
 myonic	 <p>SMARTtorque® S605 SMARTtorque® S605C SMARTtorque® S615</p> <p>SMARTtorque® S615C</p> <p><b>Ref.: 34-2115</b> (Ref. KaVo: 1.008.4164)</p>	<p>Tapa Ref.: 44-7051 Llave Doble Ref.: 30-604</p> <p><b>144<sup>80</sup>€</b></p>
 myonic	 <p>SUPERtorque® 650B SUPERtorque® 650C</p> <p><b>Ref.: 34-2116</b> (Ref. KaVo: 0.553.8051)</p>	<p>Tapa Ref.: 44-8061 Llave Doble Ref.: 30-604</p> <p><b>144<sup>80</sup>€</b></p>
 myonic	 <p>CONTRACTair® 632B CONTRACTair® 632C Bella-Torque® 639B</p> <p>Bella-Torque® 639C Bella-Torque® 642B Bella-Torque® 642C</p> <p>Bella-Torque® 645B Bella-Torque® 645C</p> <p><b>Ref.: 34-2126</b> (Ref. KaVo: 0.553.6911)</p>	<p>Tapa Ref.: 44-5081 Llave Ref. : 30-609</p> <p><b>144<sup>80</sup>€</b></p>
 myonic	 <p>Bella-Torque® 637B Bella-Torque® 637C Mira LUX 635</p> <p><b>Ref.: 34-2136</b> (Ref. KaVo: 0.553.8661)</p>	<p>Tapa Ref.: 44-8491 Llave Ref. : 05-KE1637T</p> <p><b>144<sup>80</sup>€</b></p>
 myonic	 <p>SUPERtorque® 655B SUPERtorque® 655C SUPERtorque® 660B</p> <p>SUPERtorque® 660C</p> <p><b>Ref.: 34-2146</b> (Ref. KaVo: 1.000.2078)</p>	<p>Tapa Ref.: 44-2076 Llave Doble Ref. : 30-604</p> <p><b>144<sup>80</sup>€</b></p>
 myonic	 <p>GENTLEsilence mini® 4500B GENTLEsilence mini® 4500C GENTLEsilence mini® 5000B</p> <p>GENTLEsilence mini® 5000C</p> <p><b>Ref.: 34-2154</b> (Ref. KaVo: 1.006.4564)</p>	<p><b>144<sup>80</sup>€</b></p>
 myonic	 <p>GENTLEforce® 7000B GENTLEforce® 7000C</p> <p><b>Ref.: 34-2156</b> (Ref. KaVo: 1.000.4772)</p>	<p>Tapa Ref.: 44-2076 Llave Doble Ref.: 30-604</p> <p><b>144<sup>80</sup>€</b></p>
 myonic	 <p>SMARTtorque® S619L SMARTtorque® S619C SMARTtorque® S609C</p> <p><b>Ref.: 34-2176</b> (Ref. KaVo: 1.008.4163)</p>	<p>Tapa Ref.: 44-2076 Llave Doble Ref.: 30-604</p> <p><b>144<sup>80</sup>€</b></p>
 myonic	 <p>GENTLEsilence® 8000B GENTLEsilence® 8000C GENTLEsilence® 6500BR</p> <p><b>Ref.: 34-2186</b> (Ref. KaVo: 1.003.6884)</p>	<p>Tapa Ref.: 44-5525 Llave Doble Ref.: 30-604</p> <p><b>144<sup>80</sup>€</b></p>



	Modelos para KaVo®	Relacionados
 Imagen no disponible myonic	GENTLEsilence® 6500B  <b>Ref.: 34-2187</b> (Ref. KaVo: 1.003.9664)	<b>144'80€</b>
 myonic	POWERtorque® 646B POWERtorque® 646C POWERtorque® 646CP COMPACTtorque® 636B  COMPACTtorque® 636P COMPACTtorque® 636CP (excepto 636 C)  <b>Ref.: 34-2196</b> (Ref. KaVo: 0.553.8911)	<b>144'80€</b>  Tapa Ref.: 44-8061 Llave Doble Ref.: 30-604
 myonic	EXPERTtorque® E680 (Todos) EXPERTtorque® E679  <b>Ref.: 34-2168</b> (Ref. KaVo: 1.007.9313)	<b>144'80€</b>  Tapa Ref.: 34-8903 Llave Doble Ref.: 30-604
 myonic	MASTERtorque® M9000 MASTERtorque® M9000L  <b>Ref.: 34-2190</b> (Ref. KaVo: 2.000.2266)	<b>144'80€</b>  Tapa Ref.: 44-5525 Llave Doble Ref.: 30-604
 myonic	EXPERTtorque® E677 EXPERTtorque® E677LM EXPERTtorque® E675  <b>Ref.: 34-2170</b> (Ref. KaVo: 1.007.9457)	<b>144'80€</b>  Tapa Ref.: 44-7051 Llave Ref.: 30-604

## Rotores compatibles turbinas Bien Air®

RUMAR

	Modelos para Bien Air®	Relacionados
 myonic	Croma M Ondine Prestilina  Prestige (antigua)  <b>Ref.: 34-2446**</b> (Ref. Bien Air: 209.30.19)	<b>158'00€</b>  Tapa Ref.: 34-2459
 myonic	Black Pearl Croma X S25  Croma S Boralina Black Pearl ECO  <b>Ref.: 34-2456</b> (Ref. Bien Air: 150.0164)	<b>144'80€</b>  Tapa Ref.: 34-2459
 myonic	Bora (Todas) Tornado X  <b>Ref.: 34-2466</b> (Ref. Bien Air: 150.0181)	<b>144'80€</b>  Tapa Ref.: 44-2468 Tapa Ref.: 34-2469 Llave Doble Ref.: 49-802
 myonic	Prestige S30 Prestige S32  <b>Ref.: 34-2476</b> (Ref. Bien Air: 150.0486)	<b>144'80€</b>  Tapa Ref.: 49-651 Llave Ref.: 49-803

**GARANTÍA** de 12 meses sobre la pinza







**SI NO ENCUENTRAS EL REPUESTO QUE BUSCAS, ¡CONSÚLTANOS!**

RUMAR











Modelos para Bien Air®		Relacionados
	Eolia Black Pearl ECO <b>(Confirmar con imagen)</b>	
	<b>Ref.: 34-2486**</b>	<b>158<sup>00</sup>€</b>
	Tornado	Llave Ref.: 49-831
	<b>Ref.: 34-2468</b> (Ref. Bien Air: 150.1968)	<b>144<sup>80</sup>€</b>
	Tornado S®	
	<b>Ref.: 34-2470**</b> (Ref. Bien Air: 150.1969)	<b>144<sup>80</sup>€</b>

▶ Rotores compatibles turbinas **Sirona® / Siemens®**

RUMAR











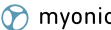

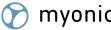

Modelos para Sirona® / Siemens®		Relacionados
	Siemens® TM1® Siemens® 4000ML® Siemens® 4000M®	Tapa Ref.: 34-4000 Llave Ref.: 30-591
	<b>Ref.: 34-2216</b> (Ref. Siemens: 5951595)	<b>144<sup>80</sup>€</b>
	TS1® TS2® 4000SL®	4000S® Siemens® T1 Control®
	<b>Ref.: 34-2226</b> (Ref. Sirona: 5953054)	Tapa Ref.: 34-4000 Llave Ref.: 30-591
	T1 Control (N/S<502.000) TC3 Control (N/S<65.000)	Tapa Ref.: 41-210 Llave Ref.: 30-592
	<b>Ref.: 34-2236</b> (Ref. Sirona: 4175217)	<b>144<sup>80</sup>€</b>
	T2 Control T1 Control (502.000<N/S<600.000) TC3 Control (50.000<N/S<700.000)	Siropure P Control
	<b>Ref.: 34-2246</b> (Ref. Sirona: 5868299, 5957126)	Tapa Ref.: 41-211 Llave Ref.: 30-592
	T1 Control (600.000<N/S<800.000)	
	<b>Ref.: 34-2238**</b> (Ref. Sirona: 6432608)	<b>144<sup>80</sup>€</b>
	T1 Control (N/S>800.000)	
	<b>Ref.: 34-2248**</b> (Ref. Sirona: 6710367)	<b>158<sup>00</sup>€</b>

BAJO PEDIDO

	Modelos para Sirona® / Siemens®	Relacionados
	T2 Control (600.000<N/S<800.000) <b>Ref.: 34-2247**</b> (Ref. Sirona: 6432590) <b>144'80,€</b>	
	T2 Control (N/S>800.000) <b>Ref.: 34-2249**</b> (Ref. Sirona: 6710425) <b>158'00,€</b>	<b>BAJO PEDIDO</b>
	T2 Racer T3 Racer (N/S <600.000) Siropure P Racer (N/S <600.000) <b>Ref.: 34-2256</b> (Ref. Sirona: 5868307) <b>144'80,€</b>	<b>Tapa Ref.: 41-205</b> <b>Llave Ref.: 30-591</b>
	T3 Racer (N/S>600.000) T4 Racer (N/S>600.000) <b>Ref.: 34-2257</b> (Ref. Sirona: 6486240) <b>144'80,€</b>	<b>Tapa Ref.: 41-212</b> <b>Llave Ref.: 30-612</b>
	T1 mini (65.000<N/S<502.000) Siropure P mini <b>(Confirmar con imagen)</b> <b>Ref.: 34-2260</b> (Ref. Sirona: 4178591) <b>144'80,€</b>	<b>Llave Ref.: 30-591</b>
	T2 mini (N/S <600.000) T3 mini (N/S <600.000) T1 mini (502.000<N/S<600.000) <b>(Confirmar con imagen)</b> Siropure P mini <b>Ref.: 34-2261</b> (Ref. Sirona: 5868315, 5868331) <b>144'80,€</b>	<b>Llave Ref.: 30-591</b>
	T1 mini (600.000<N/S<700.000) <b>Ref.: 34-2251**</b> (Ref. Sirona: 6432640) <b>158'00,€</b>	<b>BAJO PEDIDO</b>
	T1 mini CBM (700.000<N/S<800.000) <b>Ref.: 34-2252**</b> (Ref. Sirona: 6548106) <b>144'80,€</b>	<b>BAJO PEDIDO</b>
	T1 mini (N/S>800.000) <b>Ref.: 34-2253**</b> (Ref. Sirona: 6710417) <b>158'00,€</b>	<b>BAJO PEDIDO</b>
	T2 mini (600.000<N/S<700.000) T3 mini (600.000<N/S<700.000) <b>Ref.: 34-2263**</b> (Ref. Sirona: 6432632) <b>144'80,€</b>	<b>Tapa Ref.: 41-213</b> <b>Llave Ref.: 30-592</b>

**GARANTÍA** de 12 meses sobre la pinza

**SI NO ENCUENTRAS EL REPUESTO QUE BUSCAS, ¡CONSÚLTANOS!**

Modelos para Sirona® / Siemens®		Relacionados
	T2 mini (700.000<N/S<800.000) T3 mini (700.000<N/S<800.000)	Tapa Ref.: 41-213 Llave Ref.: 30-592
	<b>Ref.: 34-2265**</b> (Ref. Sirona: 6548130)	<b>158'00€</b>
	T2 mini (N/S>800.000) T3 mini (N/S>800.000)	
	<b>Ref.: 34-2250**</b> (Ref. Sirona: 6710441)	<b>158'00€</b> <b>BAJO PEDIDO</b>
	Siroboost (Todos)	Llave Ref.: 30-591
	<b>Ref.: 34-2262</b> (Ref. Sirona: 6334598)	<b>144'80€</b>
	T1 Boost (N/S>600.000)	Tapa Ref.: 49-814 Llave Ref.: 30-612
	<b>Ref.: 34-2258**</b> (Ref. Sirona: 6432624)	<b>144'80€</b> <b>BAJO PEDIDO</b>
	T1 Boost (N/S>700.000)	Tapa Ref.: 49-836
	<b>Ref.: 34-2259**</b> (Ref. Sirona: 6547694)	<b>144'80€</b>
	T2 Boost (N/S>600.000) T3 Boost (N/S>600.000)	Llave Ref.: 30-612
	<b>Ref.: 34-2264**</b> (Ref. Sirona: 6432616)	<b>158'00€</b>
	T2 Boost CBM (N/S>700.000) T3 Boost CBM (N/S>700.000) <b>(Confirmar con imagen)</b>	Llave Ref.: 30-612
	<b>Ref.: 34-2266**</b> (Ref. Sirona: 6548122)	<b>158'00€</b>
	T2 Boost (N/S>800.000) T3 Boost (N/S>800.000)	
	<b>Ref.: 34-2254**</b> (Ref. Sirona: 6710433)	<b>144'80€</b> <b>BAJO PEDIDO</b>

## Rotores compatibles turbinas W&amp;H®









\*Las letras a continuación indican el **tipo de conexión** y **NO influyen** en el modelo de rotor en los casos indicados:

BC o C BC: Borden 3  
N o C N: NSK MACH

RM o C RM: Midwest 4  
B o C B: Bien Air (Unifix)

S o C S: Sirona (Click&Go)  
M o C M: KaVo (Multiflex)

NQ o C NQ: NSK QD-J  
\_ o C: W&H (Roto Quick)

	Modelos para W&H®			Relacionados
 myonic	Top Air 195 Top Air 198 Top Air 398	Top Air 698 Top Air 795 Top Air 797	Top Air 798 Top Air 895 Top Air 898	Tapa Ref.: 30-4165 Llave Ref.: 30-606
	<b>Ref.:</b> 34-2336 (Ref. W&H: 02760000)		144 <sup>80</sup> €	
 myonic	Top Air 196 Top Air 796 Top Air 896			
	<b>Ref.:</b> 34-2345 (Ref. W&H: 02765500)		144 <sup>80</sup> €	
 myonic	Trend TC 80 Trend TC 95B Trend TC RM			Llave Ref.: 30-606
	<b>Ref.:</b> 34-2356 (Ref. W&H: 03305000)		144 <sup>80</sup> €	
 myonic	Synea TA-98* sin luz (tapa 2 muescas) Synea TA-98L Synea TA-98LC*	Alegra TE-95 (2003-2008)		Tapa Ref.: 30-4168
	<b>Ref.:</b> 34-2366 (Ref. W&H: 04396600)		144 <sup>80</sup> €	
 myonic	Synea TA-96*			Tapa Ref.: 34-0096
	<b>Ref.:</b> 34-2346 (Ref. W&H: 04396700)		144 <sup>80</sup> €	
 myonic	Top Air 290B Top Air 295 Top Air 390	Top Air 393 Top Air 395 Top Air 695		
	<b>Ref.:</b> 34-2347 (Ref. W&H: 04396700)		144 <sup>80</sup> €	
 myonic	Alegra TE-95* (2009-2013) Alegra TE-98* Alegra TE-98 C LED			Tapa Ref.: 34-9800 Llave Ref.: 30-606
	<b>Ref.:</b> 34-2386 (Ref. W&H: 04457300 / 05958900 / 05959000 / 0446300)		144 <sup>80</sup> €	
 myonic	Synea TA98C LED* (tapa 2 y 3 muescas) Synea TA-98* sin luz (tapa 3 muescas)			Tapa Ref.: 30-4166 Llave Doble Ref.: 30-602
	<b>Ref.:</b> 34-2316 (Ref. W&H: 05307000 / 05306900)		144 <sup>80</sup> €	
 myonic	Synea TA-97* Synea TA-97C LED* Alegra TE-97*	Alegra TE-97 C LED* (2009-2013)		Tapa Ref.: 49-652 Llave Doble Ref.: 30-602
	<b>Ref.:</b> 34-2326 (Ref. W&H: 05307200 / 05959100 / 05959200)		144 <sup>80</sup> €	











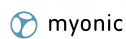

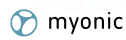

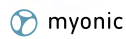
GARANTÍA de 12 meses sobre la pinza

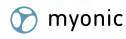
SI NO ENCUENTRAS EL REPUESTO QUE BUSCAS, ¡CONSÚLTANOS!

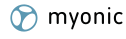

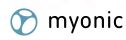
Modelos para W&H®

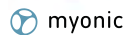
Relacionados

	 <p>Synea Fusion TG-97 Synea TK-97 Vision</p> <p><b>Ref.: 34-2317</b> (Ref. W&amp;H: 07006000)</p>	<p><b>144'80€</b></p>
	 <p>Synea Fusion TG-98 Synea TK-98 Vision</p> <p><b>Ref.: 34-2318</b> (Ref. W&amp;H: 07005900)</p>	<p><b>144'80€</b></p> <p>Tapa Ref.: 49-653</p>
	<p><b>∅ aspa: 9,78mm</b></p>  <p>Alegra HS2014 TE-95* (2014-actual) TE-98 LQ <b>(Confirmar con imagen)</b></p> <p><b>Ref.: 34-2388</b></p>	<p><b>144'80€</b></p> <p>Tapa Ref.: 49-656 Llave Ref.: 49-829</p>
	<p><b>∅ aspa: 9,66mm</b></p>  <p>Alegra HS2014 TE-97* (2014-actual) TE-97 LQ <b>(Confirmar con imagen)</b></p> <p><b>Ref.: 34-2389**</b></p>	<p><b>158'00€</b></p> <p>Tapa Ref.: 49-657 Llave Doble Ref.: 30-610</p>
	<p><b>∅ aspa: 9,76mm</b></p>  <p>Alegra HS2014 TE-98* (2014-actual) <b>(Confirmar con imagen)</b></p> <p><b>Ref.: 34-2390</b> (Ref. W&amp;H: 06787501)</p>	<p><b>158'00€</b></p> <p>Tapa Ref.: 49-656 Llave Ref.: 49-829</p>
	 <p>RC-95BC RC-95BM</p> <p><b>Ref.: 34-2385**</b></p>	<p><b>144'80€</b></p>
	 <p>Synea Vision TK-100</p> <p><b>Ref.: 34-2320</b></p>	<p><b>158'00€</b></p> <p>Tapa Ref.: 49-654</p>

PRECIO MÁS BAJO



Rotores compatibles turbinas NSK®







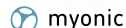



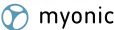

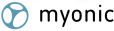

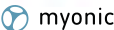

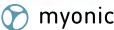

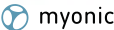

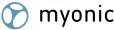
RUMAR

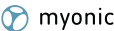

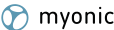

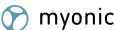

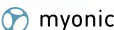













\*Las letras "K", "S", "W" y "B" indican el sistema de acople de la turbina y NO influyen en el modelo del rotor.

Modelos para NSK®

Relacionados











	 <p>CH-QD M NL-65 M</p> <p><b>Ref.: 30-0001</b> (Ref. NSK: NCH-MU03)</p>	<p><b>144'80€</b></p>
--	---	-----------------------

Modelos para NSK®		Relacionados
	 <p>CH-QD S NL-65 S Ti-MAX A450*</p> <p>Ref.: <b>30-0002</b> (Ref. NSK: NCH-SU03)</p> <p><b>144'80€</b></p>	Ti-MAX A450*L Llave Doble Ref.: 30-600
	 <p>CH-QD T NL-65 T Ti-MAX A455*</p> <p>Ref.: <b>30-0003</b> (Ref. NSK: NCH-TU03)</p> <p><b>144'80€</b></p>	Ti-MAX A455*L
	 <p>Ti-MAX A200* Ti-MAX A200*L Mach-Lite XT M</p> <p>Ref.: <b>30-0004</b> (Ref. NSK: NMC-MU03)</p> <p><b>144'80€</b></p>	
	 <p>Ti-MAX A500* Ti-MAX A500*L Ti-MAX NL95M*</p> <p>Ref.: <b>30-0007</b> (Ref. NSK: Ti-MU03)</p> <p><b>144'80€</b></p>	Llave Ref.: 15-107
	 <p>Ti-MAX A600* Ti-MAX A600*L Ti-MAX NL95S*</p> <p>Ref.: <b>30-0008</b> (Ref. NSK: Ti-SU03, NMC-SU03)</p> <p><b>144'80€</b></p>	Ti-MAX NL45S Ti-MAX A300* Ti-MAX A300*L Mach-Lite XT S Llave Doble Ref.: 30-600
	 <p>Ti-MAX A700* Ti-MAX A700*L Ti-MAX NL95T*</p> <p>Ref.: <b>30-0009</b> (Ref. NSK: Ti-TU03, NMC-TU03)</p> <p><b>144'80€</b></p>	Ti-MAX NL45T Ti-MAX A400* Ti-MAX A400*L Mach-Lite XT T Llave Doble Ref.: 30-600
	 <p>Ti-MAX X500* Ti-MAX X500*L NL9000M*</p> <p>Ref.: <b>30-0010</b> (Ref. NSK: TiX-MU03)</p> <p><b>144'80€</b></p>	Tapa Ref.: 41-223 Llave Doble Ref.: 30-605
	 <p>Ti-MAX X600* Ti-MAX X600*L NL9000S*</p> <p>Ref.: <b>30-0011</b> (Ref. NSK: TiX- SU03)</p> <p><b>144'80€</b></p>	Ti-MAX X650* Ti-MAX X650*L Tapa Ref.: 41-224 Llave Doble Ref.: 30-605
	 <p>Ti-MAX X700* Ti-MAX X700*L NL9000*L</p> <p>Ref.: <b>30-0012</b> (Ref. NSK: TiX-TU03)</p> <p><b>144'80€</b></p>	Tapa Ref.: 41-225 Llave Doble Ref.: 30-605
	 <p>Pana Air Σ T</p> <p>Ref.: <b>30-0013</b> (Ref. NSK: NPA-TU03)</p> <p><b>128'00€</b></p>	

	Modelos para NSK®	Relacionados
 myonic	 <p>S-Max M500* S-Max M500*L Pana-Max Plus M</p> <p>S-Max M800* S-Max M500*L</p> <p><b>Ref.: 30-0014</b> (Ref. NSK: SX-MU03)</p>	<p>Tapa Ref.: 41-226</p> <p><b>128'00€</b></p>
 myonic	 <p>TI-MAX Z800* TI-MAX Z800*L</p> <p><b>Ref.: 30-0018**</b></p>	<p>Tapa Ref.: 34-8905 Llave Doble Ref.: 30-614</p> <p><b>168'00€</b></p>
 myonic	 <p>TI-MAX Z900* TI-MAX Z900*L</p> <p><b>Ref.: 30-0015**</b></p>	<p>Tapa Ref.: 34-8904 Llave Doble Ref.: 30-614</p> <p><b>168'00€</b></p>
 myonic	 <p>S-Max Pico</p> <p><b>Ref.: 30-0016</b></p>	<p>Llave Doble Ref.: 30-632</p> <p><b>168'00€</b></p>
 myonic	 <p>Pana-Max T QD T Pana-Max TUM4</p> <p><b>Ref.: 44-220</b> (Ref. NSK: PAX-TU03)</p>	<p><b>144'80€</b></p>
 myonic	 <p>Pana-Max S QD S Pana-Max SUM4</p> <p><b>Ref.: 44-221</b> (Ref. NSK: PAX-SU03)</p>	<p><b>144'80€</b></p>
 myonic	 <p>Pana-Max 2</p> <p><b>Ref.: 44-222**</b> (Ref. NSK: PAX2-SU03)</p>	<p><b>144'80€</b></p>
 myonic	 <p>Pana Air Σ S ECO TOPtorque</p> <p><b>Ref.: 46-357</b> (Ref. NSK: NPA-SU03)</p>	<p><b>118'00€</b></p>
 myonic	 <p>S-Max M600* S-Max M600*L Pana-Max Plus S</p> <p>PAP-SUM4</p> <p><b>Ref.: 46-359</b> (Ref. NSK: SX-SU03)</p>	<p>Tapa Ref.: 41-227 Llave Doble Ref.: 30-632</p> <p><b>144'80€</b></p>
 myonic	 <p>S-Max M900* S-Max M900*L</p> <p><b>Ref.: 46-360</b> (Ref. NSK: SX-SU03)</p>	<p>Tapa Ref.: 41-227 Llave Doble Ref.: 30-632</p> <p><b>144'80€</b></p>

Rotores compatibles turbinas **Castellini®**, **Anthos®**

RUMAR

	Modelos para Castellini® / Anthos®	Relacionados
 myonic	 <p>Hi Power M Cleanlight Cleanair</p> <p><b>Ref.: 34-2506</b> (Ref. Castellini: L0000874)</p>	<p><b>Tapa Ref.:</b> 49-801 <b>Llave Ref.:</b> 49-800</p> <p><b>144'80€</b></p>
 myonic	 <p>Titanium Gold 2 Hi Power Light Gold</p> <p>Hi Power 2 Hi Power Ceramic</p> <p><b>Ref.: 34-2516</b> (Ref. Castellini: L0001370)</p>	<p><b>Tapa Ref.:</b> 49-811 <b>Llave Ref.:</b> 49-810</p> <p><b>144'80€</b></p>
 myonic	 <p>Silent Silent Power Silver 2L</p> <p><b>Ref.: 34-2526</b></p>	<p><b>Tapa Ref.:</b> 49-827 <b>Llave Ref.:</b> 49-824</p> <p><b>144'80€</b></p>
 myonic	 <p>Silent Power Gold Silent Power Silver 4L (Excepto EVO 4L)</p> <p><b>Ref.: 34-2528</b> (Ref. Castellini: L0001857)</p>	<p><b>Tapa Ref.:</b> 49-827 <b>Llave Ref.:</b> 49-824</p> <p><b>144'80€</b></p>
 myonic	 <p>Silent Power EVO 2 Silent Power EVO 2L Silent Power EVO 4L</p> <p>Silent Power EVO 4LK</p> <p><b>Ref.: 34-2518</b></p>	<p><b>Tapa Ref.:</b> 49-825 <b>Llave Ref.:</b> 49-822</p> <p><b>144'80€</b></p>







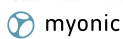

Rotores compatibles turbinas **FONA®**

RUMAR

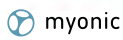
	Modelos para FONA®	Relacionados
 myonic	 <p>6080MR (Standard) 8060SR (Standard)</p> <p><b>Ref.: 34-2256</b></p>	<p><b>Tapa Ref.:</b> 41-205</p> <p><b>144'80€</b></p>
 myonic	 <p>6080MM (Mini) 8080SM (Mini)</p> <p><b>Ref.: 34-2261</b></p>	<p><b>144'80€</b></p>
 myonic	 <p>8080SR (Standard)</p> <p><b>Ref.: 34-2262</b></p>	<p><b>144'80€</b></p>

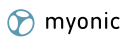

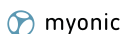
Rotores compatibles turbinas **B.A. International®**

RUMAR

Modelos para B.A. International®		Relacionados
	 <p>B.A. Ultimate 670 B.A. Ultimate 650</p> <p>Ref.: <b>34-2106</b></p>	<p><b>144<sup>80</sup>€</b></p>
	 <p>B.A. Ultimate 685 B.A. Ultimate 535</p> <p>Ref.: <b>34-2256</b></p>	<p><b>144<sup>80</sup>€</b></p>
	 <p>B.A. Ultimate 695 <b>(Confirmar con imagen)</b></p> <p>Ref.: <b>34-2266**</b></p>	<p><b>158<sup>00</sup>€</b></p>
	 <p>B.A. Ultimate 755</p> <p>Ref.: <b>34-2262</b></p>	<p><b>144<sup>80</sup>€</b></p>



Rotores compatibles turbinas **CHIRANA®**

RUMAR

Modelos para CHIRANA®		Relacionados
	 <p>TG 656 TGL 637A (smile - music)</p> <p>Ref.: <b>34-2106</b></p>	<p><b>144<sup>80</sup>€</b></p>

Rotores compatibles turbinas **MICROMEGA®**

RUMAR



Modelos para MICROMEGA®		Relacionados
	 <p>350</p> <p>Ref.: <b>34-2550</b></p>	<p><b>144<sup>80</sup>€</b></p> <p><b>HASTA AGOTAR</b></p>



**Rotores compatibles turbinas R-Tech®**



- Rodamientos cerámicos.
- Con anillos tóricos, arandelas metálicas y anillos de teflón según modelo.
- **Garantía:** 6 meses sobre la pinza

Modelos para R-Tech®		Relacionados
 <p>PowerMax</p> <p><b>Ref.: 42-401</b></p> <p><b>98'00€</b></p>		<p>Tapa Ref.: 42-415</p> <p><b>HASTA AGOTAR</b></p>
 <p>ECO T2 ECO T3 LED PRO T1 L</p> <p><b>Ref.: 58-250R</b></p> <p><b>64'80€</b></p>		<p>Tapa Ref.: 58-250T Llave Ref.: 58-252K</p>
 <p>ECO T TURBO COXO TITAN</p> <p><b>Ref.: 58-253R</b></p> <p><b>78'00€</b></p>		<p>Tapa Ref.: 58-253T Llave Ref.: 58-253K</p>

**ROTORES TURBINAS LABORATORIO**

**Rotores compatibles turbinas laboratorio Bien Air®**





Modelos para Bien Air®		Relacionados
 <p>Serie TD (Todos los modelos)</p> <p><b>Ref.: 34-2496</b></p> <p><b>198'00€</b></p>		

myonic

**Rotores compatibles turbinas laboratorio NSK®**



Modelos para NSK®		Relacionados
 <p>Presto</p> <p><b>Ref.: 30-0080</b> (Ref. NSK: T815-016)</p> <p><b>188'00€</b></p>		
 <p>Presto AQUA (Excepto LUX)</p> <p><b>Ref.: 30-0081</b> (Ref. NSK: T816-016)</p> <p><b>178'00€</b></p>		

myonic

**GARANTÍA** de 12 meses sobre la pinza  
**SI NO ENCUENTRAS EL REPUESTO QUE BUSCAS, ¡CONSÚLTANOS!**









# ROTORES MK-dent para TURBINAS

- RODAMIENTOS CERÁMICOS myonic.  
- Inserto de Acero o de Carburo en función del modelo.

- Con anillos tóricos y arandelas metálicas, según modelo.  
- **Garantía:** 12 meses sobre la pinza.

## Rotores compatibles turbinas KaVo®



Modelos para KaVo®		Relacionados
	606B, 606C 625B, 625C SUPERtorque® 630B  SUPERtorque® 630C SUPERtorque® 640B SUPERtorque® 640C	Tapa Ref.: 44-6511 para 640 Tapa Ref.: 49-830 para 630 Llave Ref. : 30-609
	<b>Ref.: 05-TC1640BK</b> (Ref. KaVo: 0.553.5881)	<b>144<sup>80</sup>€</b>
	SUPERtorque® 650B SUPERtorque® 650C	Tapa Ref.: 44-8061 Llave Doble Ref.: 30-604
	<b>Ref.: 05-TC1650BK</b> (Ref. KaVo:0.553.8051)	<b>144<sup>80</sup>€</b>
	CONTRACTair® 632B CONTRACTair® 632C Bella-Torque® 639B  Bella-Torque® 639C Bella-Torque® 642B Bella-Torque® 642C	Tapa Ref.: 44-5081
	<b>Ref.: 05-TC1642BK</b> (Ref. KaVo: 0.553.6911)	<b>144<sup>80</sup>€</b>
	MIRAtorque® 637B MIRAtorque® 637C	Tapa Ref.: 44-8491 Llave Ref. : 05-KE1637T
	<b>Ref.: 05-TC1637BK</b> (Ref. KaVo: 0.553.8661)	<b>144<sup>80</sup>€</b>
	SUPERtorque® 655B SUPERtorque® 655C SUPERtorque® 660B  SUPERtorque® 660C	Tapa Ref.: 44-2076 Llave Doble Ref. : 30-604
	<b>Ref.: 05-TC1655BK</b> (Ref. KaVo: 1.000.2078)	<b>144<sup>80</sup>€</b>
	GENTLEsilence mini® 4500B GENTLEsilence mini® 4500C GENTLEsilence mini® 5000B  GENTLEsilence mini® 5000C	
	<b>Ref.: 05-TC1500BK</b> (Ref. KaVo: 1.006.4564)	<b>144<sup>80</sup>€</b>
	GENTLEforce® 7000B GENTLEforce® 7000C	Tapa Ref.: 44-2076 Llave Doble Ref.: 30-604
	<b>Ref.: 05-TC1700BK</b> (Ref. KaVo: 1.000.4772)	<b>144<sup>80</sup>€</b>
	GENTLEsilence® 8000B GENTLEsilence® 8000C GENTLEsilence® 6500BR	Tapa Ref.: 44-5525 Llave Doble Ref.: 30-604
	<b>Ref.: 05-TC1800BK</b> (Ref. KaVo: 1.003.6884)	<b>144<sup>80</sup>€</b>
	GENTLEsilence® 6500B	
	<b>Ref.: 05-TC1650US</b> (Ref. KaVo: 1.003.9664)	<b>144<sup>80</sup>€</b>

	Modelos para Modelos para KaVo®	Relacionados
	POWERtorque® 646B POWERtorque® 646C POWERtorque® 646CP COMPACTtorque® 636B COMPACTtorque® 636P COMPACTtorque® 636CP (excepto 636 C)	<b>Tapa Ref.:</b> 44-8061 <b>Llave Doble Ref.:</b> 30-604
	<b>Ref.:</b> <b>05-TC1636BK</b> (Ref. KaVo: 0.553.8911)	<b>144<sup>80</sup>€</b>
	EXPERTtorque® E680 (Todos) EXPERTtorque® E679	<b>Tapa Ref.:</b> 34-8903 <b>Llave Doble Ref.:</b> 30-604
	<b>Ref.:</b> <b>05-TC1680BK</b> (Ref. KaVo: 1.007.9313)	<b>144<sup>80</sup>€</b>
 <small>Imagen no disponible</small>	MASTERtorque® M9000 MASTERtorque® M9000	<b>Tapa Ref.:</b> 44-5525 <b>Llave Doble Ref.:</b> 30-604
	<b>Ref.:</b> <b>05-TC1900BK</b> (Ref. KaVo: 2.000.2266)	<b>144<sup>80</sup>€</b>

## Rotores compatibles turbinas W&H®







\*Las letras a continuación indican el **tipo de conexión** y **NO influyen** en el modelo de rotor en los casos indicados:

BC o C BC: Borden 3  
N o C N: NSK MACH

RM o C RM: Midwest 4  
B o C B: Bien Air (Unifix)

S o C S: Sirona (Click&Go)  
M o C M: KaVo (Multiflex)

NQ o C NQ: NSK QD-J  
\_ o C: W&H (Roto Quick)

	Modelos para W&H®	Relacionados
	Synea TA-98* sin luz (tapa 2 muescas) Alegra TE-95 (2003-2008) Synea TA-98L Synea TA-98LC*	<b>Tapa Ref.:</b> 30-4168
	<b>Ref.:</b> <b>05-TC1011W</b> (Ref. W&H: 04396600)	<b>144<sup>80</sup>€</b>
	Synea TA-96*	<b>Tapa Ref.:</b> 34-0096
	<b>Ref.:</b> <b>Ref. 05-TC1012W</b> (Ref. W&H: 04396700)	<b>144<sup>80</sup>€</b>
	Synea TA-97* Alegra TE-97 C LED* (2009-2013) Synea TA-97C LED* Alegra TE-97*	<b>Tapa Ref.:</b> 49-652 <b>Llave Doble Ref.:</b> 30-602
	<b>Ref.:</b> <b>05-TC1097WT</b> (Ref. W&H: 05307200 / 05959100 / 05959200)	<b>144<sup>80</sup>€</b>
	Synea TA98C LED* (tapa 2 y 3 muescas) Synea TA-98* sin luz (tapa 3 muescas)	<b>Tapa Ref.:</b> 30-4166 <b>Llave Doble Ref.:</b> 30-602
	<b>Ref.:</b> <b>05-TC1098WT</b> (Ref. W&H: 05307000 / 05306900)	<b>144<sup>80</sup>€</b>

**GARANTÍA** de 12 meses sobre la pinza

**SI NO ENCUENTRAS EL REPUESTO QUE BUSCAS, ¡CONSÚLTANOS!**

Rotores compatibles turbinas **Bien Air®**



Modelos para Bien Air®		Relacionados
	Black Pearl Cromax S25 (Confirmar con imagen)	Cromax S Boralina Black Pearl ECO
	<b>Ref.: 05-TC1011BBP</b> (Ref. Bien Air: 150.0164)	<b>144<sup>80</sup>€</b> Tapa Ref.: 34-2459
	Bora (Todas)	Tapa Ref.: 44-2468 Tapa Ref.: 34-2469 Llave Doble Ref.: 49-802
	<b>Ref.: 05-TC1011BB</b> (Ref. Bien Air: 150.0181)	<b>144<sup>80</sup>€</b>
	Prestige S30 Prestige S32	Tapa Ref.: 49-651 Llave Ref.: 49-803
	<b>Ref.: 05-TC1011BP</b> (Ref. Bien Air: 150.0486)	<b>144<sup>80</sup>€</b>

HASTA AGOTAR

Rotores compatibles turbinas **Sirona®**



Modelos para Sirona®		Relacionados
	T1 Control (N/S <502.000) TC3 Control (N/S <65.000)	Tapa Ref.: 41-210 Llave Ref.: 30-592
	<b>Ref.: 05-TC1011S1-CS5</b> (Ref. Sirona: 4175217)	<b>144<sup>80</sup>€</b>
	T2 Racer T3 Racer (N/S <600.000) Siropure P Racer (N/S <600.000)	Tapa Ref.: 41-205 Llave Ref.: 30-591
	<b>Ref.: Ref. 05-TC1011S2R</b> (Ref. Sirona: 5868307)	<b>144<sup>80</sup>€</b>

Rotores compatibles turbinas **NSK®**



\*Las letras "K", "S", "W" y "B" indican el sistema de acople de la turbina y **NO influyen** en el modelo del rotor.

Modelos para NSK®		Relacionados
	Ti-MAX X600* Ti-MAX X600*L NL9000S*	Ti-MAX X650* Ti-MAX X650*L
	<b>Ref.: 05-TC1600NX</b> (Ref. NSK: TiX- SU03)	<b>144<sup>80</sup>€</b> Tapa Ref.: 41-224 Llave Doble Ref.: 30-600
	Ti-MAX X700* Ti-MAX X700*L NL9000*L	Tapa Ref.: 41-225 Llave Doble Ref.: 30-605
	<b>Ref.: 05-TC1700NX</b> (Ref. NSK: TiX-TU03)	<b>144<sup>80</sup>€</b>

Rotores turbinas **MK-dent®** (CON INSERTOS DE CARBURO)

	Modelos			Relacionados
	HC4011 HC4021 HC6021 desde serie F	HC7031 HC7021 HC5031	HC5021 HC2022	
	<b>Ref.: 05-TC2031</b>		<b>210'00€</b>	
	HC4012 HC6012 HC5022	HC4022 HC7022 HC6022 desde serie F		
	<b>Ref.: 05-TC2032</b>		<b>210'00€</b>	
	HC2021 desde serie F HC4021 HC6021 hasta serie E	HC2002		
	<b>Ref.: 05-TC2021</b>		<b>210'00€</b>	
	HC20K HC20KL HC21K HC21KL	HC21N HC21NL HC21S	HC21SL HC21W HC21WL	
	<b>Ref.: 05-TC2038</b>		<b>210'00€</b>	
	HC22K HC22KL HC22N	HC22NL HC22S HC22SL	HC22W HC22WL	
	<b>Ref.: 05-TC2039</b>		<b>210'00€</b>	
	HC8021 HC9021 HP21K HP21KL	HP21S HP21SL HP21N	HP21NL HP21W HP21WL	
	<b>Ref.: 05-TC2041</b>		<b>210'00€</b>	
	HC8022 HC9022 HP22K HP22KL	HP22S HP22SL HP22N	HP22NL HP22W HP22WL	
	<b>Ref.: 05-TC2042</b>		<b>210'00€</b>	

**Rotores turbinas MK-dent®** (CON PINZA DE ACERO ENDURECIDO)



Modelos para Bien Air®			Relacionados
	HB12 HB21K HE11	HE12 HE15L	
	<b>Ref.: 05-TC1021</b>		<b>144<sup>80</sup>€</b>
	HC4011 HC4021 HC6021 desde serie F	HC7031 HC7021 HC5031	HC5021 HC2022
	<b>Ref.: 05-TC1031</b>		<b>144<sup>80</sup>€</b>
	HE17 HE21K HE21KL HE21N	HE21NL HE21S HE21SL HE21W	HE21WL
	<b>Ref.: 05-TC1034</b>		<b>144<sup>80</sup>€</b>
	HE14 HE18 HE22K HE22KL	HE22N HE22NL HE22S	HE22SL HE22W HE22WL
	<b>Ref.: 05-TC1035</b>		<b>144<sup>80</sup>€</b>

# RODAMIENTOS CERÁMICOS para **TURBINA**

## MÍNIMO ABEC7

RODAMIENTOS DISEÑADOS PARA EL FUNCIONAMIENTO  
SEGÚN ESPECIFICACIONES DE CADA INSTRUMENTO

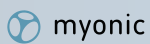









Todos los rodamientos que ofrecemos están fabricados por los principales fabricantes de rodamientos a nivel mundial: myonic®, Barden, GRW, NMB, NHBB o ESI. Todos fabricados de acuerdo a las normas de precisión ISO\* (normas para rodamientos de dimensiones métricas) y ABEC\*\* (rodamientos generalmente en dimensiones de pulgadas).

\* ISO: International Standard Organization.

\*\* ABEC: Annular Bearing Engineers Conference.

## Rodamientos turbinas KaVo®

Modelos para KaVo®			Descripción
	625 627 630 639	640 632 642 645	636 646 Delantero 637 Trasero 650
myonic	<b>Ref.: 45-6502</b> (Ref. KaVo: 0.220.0125)		<b>23'80€</b> Medidas: 3,175x6,350x2,778mm Con Rebaje Bola cerámica Angular Torlon Cerrado
	625 627 630 639	640 632 642 645	636 646 Delantero 637 Trasero 650
myonic	<b>Ref.: 45-222</b> (Ref. KaVo: 0.220.0125)		<b>17'80€</b> Medidas: 3,175x6,350x2,778mm Con Rebaje Bola cerámica Radial Torlon Cerrado
	637 Delantero 6000		
myonic	<b>Ref.: 45-352</b> (Ref. KaVo: 0.220.2015)		<b>27'80€</b> Medidas: 3,175x6,350x2,381/2,778mm Con rebaje Bola cerámica Angular Phenolic Cerrado
	Delantero 650		
myonic	<b>Ref.: 45-6501</b> (Ref. KaVo: 0.220.2009)		<b>39'80€</b> Medidas: 3,175x6,350x4,178 / 3,230mm Con Rebaje Bola cerámica Angular Torlon Cerrado
	655 660 619	609 Delantero 8000 Delantero E679	Delantero E680 Delantero 6500BR
myonic	<b>Ref.: 45-225</b> (Ref. KaVo: 1.000.7980)		<b>23'80€</b> Medidas: 3,175x6,350x2,778mm Liso Bola cerámica Angular Torlon Cerrado
	7000 Trasero 8000 Trasero E675	Trasero E677 S605 S615	Trasero 6500BR Trasero 6500B
myonic	<b>Ref.: 45-223</b> (Ref. KaVo: 1.000.7979)		<b>21'80€</b> Medidas: 3,175x6,350x2,380 / 2,778mm Liso Bola cerámica Angular Torlon Cerrado
	5000 Delantero E675 Delantero E677	Trasero E679 Trasero E680 Delantero 6500B	
myonic	<b>Ref.: 45-224</b> (Ref. KaVo: 1.007.6975)		<b>27'80€</b> Medidas: 3,175x6,439x2,413mm Con Rebaje Bola cerámica Angular Torlon Cerrado
	M9000 M9000L		
myonic	<b>Ref.: 45-205</b>		<b>26'80€</b> Medidas: 3,175x6,350x2,778mm Liso Bola cerámica Angular Torlon Integral







Rodamientos turbinas **Bien Air®** RUMAR

Modelos para Bien Air®			Descripción
	 Bora Black Pearl Cromax Boralina Eolia Series TD laboratorio		<b>Medidas:</b> 3,175x7,938x3,571mm Liso Bola cerámica Angular Torlon Cerrado
	<b>Ref.:</b> 38-615 (Ref. Bien Air: 701.01.00)		<b>21<sup>80</sup> €</b>
	 Prestige Prestilina		<b>Medidas:</b> 3,175x6,350x2,778mm Liso Bola cerámica Radial Phenolic Cerrado
	<b>Ref.:</b> 45-229 (Ref. Bien Air: 701.01.09)		<b>20<sup>80</sup> €</b>

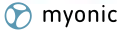

Rodamientos turbinas **Sirona® y Siemens®** RUMAR

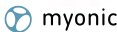
Modelos para Sirona® / Siemens®			Descripción
	 Siemens® TS1 Siemens® TS2 T1 (hasta N/S: 50.000)	TS1 TS2	<b>Medidas:</b> 3,175x6,350x2,778mm Con Rebaje Bola cerámica Radial Torlon Cerrado
	<b>Ref.:</b> 45-222		<b>17<sup>80</sup> €</b>
	 Siemens® TS1 Siemens® TS2 T1 Control (hasta N/S: 50.000)	TS1 TS2	<b>Medidas:</b> 3,175x6,350x2,778mm Con Rebaje Bola cerámica Angular Torlon Cerrado
	<b>Ref.:</b> 45-6502		<b>23<sup>80</sup> €</b>
	 T2 Control T2 Racer T3 Racer	TC3 T1 (N/S>50.000) Siroboost	T2 mini T3 mini
	<b>Ref.:</b> 45-205 (Ref. Sirona: 5994814 (K))		<b>26<sup>80</sup> €</b>
	 Siemens® TM1 Siemens® 4000ML Siemens® 4000M	T1 mini	<b>Medidas:</b> 3,175x6,350x2,380mm Con Rebaje Bola cerámica Angular Torlon Cerrado
	<b>Ref.:</b> 45-207		<b>26<sup>80</sup> €</b>

Rodamientos turbinas **W&H®** RUMAR

Modelos para W&H®			Descripción
	 Alegra TE-95 Alegra TE-97 Alegra TE-98 Toda la línea Alegra (hasta 2013)	Top Air 196 Top Air 796 Top Air 896 Top Air TC80	Top Air TC83 Top Air TC95 Top Air TC98
	<b>Ref.:</b> 45-206 (Ref. W&H: 05958600 y compatibles)		<b>16<sup>80</sup> €</b>
	 Alegra HS2014 TE-95 (2014-actual) Alegra HS2014 TE-97 (2014-actual) Alegra HS2014 TE-98	RC-95BC RC-95BM	<b>Medidas:</b> 3,175x6,310/6,350/7,518x2,778mm Reborde Bola cerámica Radial Torlon Cerrado
	<b>Ref.:</b> 45-235		<b>23<sup>80</sup> €</b>

PRECIO MÁS BAJO





Modelos para W&H®			Descripción
 myonic	Synea TA-96 Synea TA-97 Synea TA-98 Toda la línea Synea Trend	TK-97LM TK-98LM TK-100LM TG-97L TG-98L	TA-97LW Top Air 195, 198, 398 Top Air 698, 795, 797 Top Air 798, 895, 898
	<b>Ref.: 45-205</b> (Ref. W&H: 02770712, 04378600, 05288500 y compatibles) <b>26'80€</b>		<b>Medidas:</b> 3,175x6,350x2,778mm Liso Bola cerámica Angular Torlon Integral
 myonic	395 396 695	696 TK-94L TK-94LM	<b>Medidas:</b> 3,175x6,350x2,380mm Liso Bola cerámica Angular Torlon Integral
	<b>Ref.: 45-226</b> <b>27'80€</b>		

## Rodamientos turbinas NSK®

RUMAR



\*Las letras "K", "S", "W" y "B" indican el sistema de acople de la turbina y **no influyen** en el modelo del rotor

\*\* En los modelos **X500**, **X600** y **X700**, sólo es posible cambiar los rodamientos en rotores compatibles. A pesar de ser los mismos rodamientos, en los originales los rodamientos están soldados al eje por lo que no es posible cambiarlos.

Modelos para NSK®			Descripción	
 myonic	Aqua Presto Alpha Light	Phatelus	<b>Medidas:</b> 3,175x6,350x7,518x2,778mm Con Rebaje Bola cerámica Radial Phenolic Cerrado	
	<b>Ref.: 45-227</b> <b>19'80€</b>			
 myonic	Ti-MAX X600/L* Ti-MAX X700/L* Ti-MAX NL9000S/ T/ M	Trasero Ti-MAX X500/L* S-Max M600/L*	<b>Medidas:</b> 3,175x6,350x2,380mm Liso Bola cerámica Angular Torlon Integral	
	<b>Ref.: 45-226**</b> <b>27'80€</b>			
 myonic	Delantero X500/L*		<b>Medidas:</b> 3,175x6,350x2,380mm Con Rebaje Bola cerámica Angular Torlon Cerrado	
	<b>Ref.: 45-207**</b> <b>26'80€</b>			
 myonic	Trasero Ti-MAX A400/L* Ti-MAX A300/L* NL65-CH QD-NL45-MACH Trasero Pana Max T Trasero Pana Max QD-T N75-MACH Trasero Pana Max S Trasero Pana Max QD-S Pana Max PAX-TU M4/B2 Pana-Max PAX-SU M4/B2 Mach-Lite S Mach-Lite XT-M Mach-Lite XT-MU Ti-MAX A200/L* NL75 NL85	NL75 Mach-Lite M NL85 Mach-Lite M Mach 2 M/MU Mach QD-M Mach QD-S Mach-Lite XT T/TU Mach 2 T/TU NL65 Mach-Lite S NL75 Mach-Lite S NL85 Mach-Lite S NL65 Mach-Lite T NL75 Mach-Lite T NL85 Mach-Lite T Mach-Lite XT S/SU Mach 2 S/SU Pana Air Σ SU M4/B2 NL65	NL45T Phatelus 45 T/TU Phatelus II T/TU MACH-QD T Ti-MAX A455/L* Phatelus III T/TU Mach-Lite M Phatelus II M/MU NL65M Ti-MAX A600/L* Ti-MAX NL95S Ti-MAX NL45S Ti-MAX A700/L* Ti-MAX NL95T Ti-MAX NL45T	<b>Medidas:</b> 3,175x6,350x2,381mm Liso Bola cerámica Radial Phenolic Cerrado
	<b>Ref.: 45-228</b> <b>17'80€</b>			

Rodamientos turbinas **Castellini®**, **Anthos®** y **Cefla®**

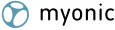
RUMAR

Modelos para Castellini®, Anthos® y Cefla®		Descripción
	Gold Silent Power  <b>Ref.: 45-205</b>	<b>Medidas:</b> 3,175x6,350x2,778mm Liso Bola cerámica Angular Torlon Integral
	Clean Air 2000 High Power M  <b>Ref.: 45-227</b>	<b>Medidas:</b> 3,175x6,350/7,518x2,778mm Con Rebaje Bola cerámica Radial Phenolic Cerrado

myonic

Ref.: 45-205

26<sup>80</sup> €

Descripción

Medidas: 3,175x6,350x2,778mm  
Liso  
Bola cerámica  
Angular  
Torlon  
Integral



myonic

Clean Air 2000  
High Power M

Ref.: 45-227

19<sup>80</sup> €

Medidas: 3,175x6,350/7,518x2,778mm

Con Rebaje  
Bola cerámica  
Radial  
Phenolic  
Cerrado

Rodamientos turbinas **FARO®**

RUMAR

Modelos para Faro®		Descripción
	S404  <b>Ref.: 45-205</b>	<b>Medidas:</b> 3,175x6,350x2,779 mm Liso Bola cerámica Angular Torlon Integral

myonic

Ref.: 45-205

26<sup>80</sup> €

Descripción

Medidas: 3,175x6,350x2,779 mm  
Liso  
Bola cerámica  
Angular  
Torlon  
Integral



S404

Rodamientos turbinas **Lares®**

RUMAR

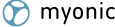
Modelos para Lares®		Descripción
	557CX 757CX  <b>Ref.: 45-226</b>	<b>Medidas:</b> 3,175x6,350x2,380mm Liso Bola cerámica Angular Torlon Integral

myonic

Ref.: 45-226

27<sup>80</sup> €

Descripción

Medidas: 3,175x6,350x2,380mm  
Liso  
Bola cerámica  
Angular  
Torlon  
Integral



557CX  
757CX

Rodamientos turbinas **TKD®**

RUMAR

Modelos para TKD®		Descripción
	Bravía Thera  <b>Ref.: 45-226</b>	<b>Medidas:</b> 3,175x6,350x2,380mm Liso Bola cerámica Angular Torlon Integral

myonic

Ref.: 45-226

27<sup>80</sup> €

Descripción





Medidas: 3,175x6,350x2,380mm  
Liso  
Bola cerámica  
Angular  
Torlon  
Integral

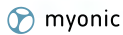

Bravía  
Thera

Rodamientos turbinas **KMD®**

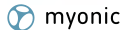

Modelos para KMD®		Descripción
	 Mistral M4 DPS  <b>Ref.: 45-228</b>	<b>Medidas:</b> 3,175x6,350x2,381mm Liso Bola cerámica Radial Phenolic Cerrado
	<b>17' 80€</b>	
	 Solaris  <b>Ref.: 45-205</b>	<b>Medidas:</b> 3,175x6,350x2,778mm Liso Bola cerámica Angular Torlon Integral
	<b>26' 80€</b>	









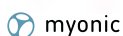

Rotores turbinas **R-Tech®**

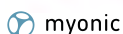

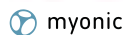

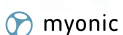

Modelos para R-Tech®		Descripción
	 Powermax  <b>Ref.: 45-226</b>	<b>Medidas:</b> 3,175x6,350x2,380mm Liso Bola cerámica Angular Torlon Integral
	<b>27' 80€</b>	

Rodamientos turbinas **MK-dent®**













Modelos para MK-dent®		Descripción
	 Delantero HC9021      Delantero HP21L Delantero HC8021      Delantero HC20 Delantero HP21          Delantero HC20L  <b>Ref.: 45-205</b>	<b>Medidas:</b> 3,175x6,350x2,778mm Liso Bola cerámica Angular Torlon Integral
	<b>26' 80€</b>	
	 Trasero HC9021      Trasero HP21L Trasero HC8021      Trasero HC20 Trasero HP21          Trasero HC20L  <b>Ref.: 45-223</b>	<b>Medidas:</b> 3,175x6,350x2,380 / 2,778mm Liso Bola cerámica Angular Torlon Cerrado
	<b>26' 80€</b>	
	 Delantero HE17      Trasero HE22 Delantero HE21      Trasero HE22L Delantero HE21L  <b>Ref.: 45-225</b>	<b>Medidas:</b> 3,175x6,350x2,778mm Liso Bola cerámica Angular Torlon Cerrado
	<b>23' 80€</b>	
	 HC7032      HC6012      HC4022      HC2012 HC7031      HC5032      HC4021      HE17 HC7022      HC5031      HC4012      Delantero HP21 HC6022 (según N/S)      HC5021      HC2022      Delantero HP21L  <b>Ref.: 45-6502</b>	<b>Medidas:</b> 3,175x6,350x2,778mm Con Rebaje Bola cerámica Angular Torlon Cerrado
	<b>23' 80€</b>	
	 HC22      HP22L HC22L      HC8022 HP22      HC9022  <b>Ref.: 45-352</b>	<b>Medidas:</b> 3,175x6,350x2,381/2,778mm Con rebaje Bola cerámica Angular Phenolic Cerrado
	<b>27' 80€</b>	

Modelos para MK-dent®		Descripción
	Trasero HE21 Trasero HE21L Trasero HE17  Delantero HE22 Delantero HE22L	<b>Medidas:</b> 3,175x6,439x2,413mm Con rebaje Bola cerámica Angular Torlon Cerrado
 myonic	<b>Ref.: 45-224</b>	<b>27,80 €</b>
	Trasero HC20 Trasero HC20L	<b>Medidas:</b> 3,175x6,350x2,381mm Liso Bola cerámica Radial Phenolic Cerrado
 myonic	<b>Ref.: 45-228</b>	<b>17,80 €</b>

# TAPAS TURBINA



RUMAR

Tapas compatibles turbinas KaVo®

	Modelos para KaVo®	Relacionados
	SMARTtorque® S605 SMARTtorque® S615C EXPERTtorque® E677  <b>Ref.: 44-7051</b> (Ref. KaVo: 1.007.7051)	Llave Doble Ref.: 30-604  <b>28'00€</b>
	624 625 625C  625D 627 630  630A  <b>Ref.: 49-830</b> (Ref. KaVo: 0.553.4041)	Llave Ref.: 30-609  <b>54'80€</b>
	MIRAlux® 635 MIRAtorque mini® 637  <b>Ref.: 44-8491</b> (Ref. KaVo: 0.553.8491)	Llave Ref.: 05-KE1637T  <b>28'00€</b>
	SUPERtorque® 647 SUPERtorque® 650 COMPACTtorque® 636  POWERtorque® 646  <b>Ref.: 44-8061</b> (Ref. KaVo: 0.553.8061)	Llave Doble Ref.: 30-604  <b>28'00€</b>
	BELLAtorque® 639 BELLAtorque® 642 BELLAtorque® 645  <b>Ref.: 44-5081</b> (Ref. KaVo: 0.553.5081)	Llave Ref.: 30-609  <b>28'00€</b>
 	SUPERtorque® 640  <b>Ref.: 44-6511</b> (Ref. KaVo: 0.553.6511)	Llave Ref.: 30-609  <b>28'00€</b>
	SMARTtorque® S609 SMARTtorque® S619 SUPERtorque® 655 SUPERtorque® 660  GENTLEforce® 6000 GENTLEforce® 7000  <b>Ref.: 44-2076</b> (Ref. KaVo: 1.000.2076 / 1.000.4770)	Llave Doble Ref.: 30-604  <b>28'00€</b>
	GENTLEsilence® 8000 MASTERtorque® M9000L  <b>Ref.: 44-5525</b> (Ref. KaVo: 1.003.5525 / 3.000.1874)	Llave Doble Ref.: 30-604  <b>28'00€</b>
	EXPERTtorque® E679L EXPERTtorque® E680L  <b>Ref.: 34-8903</b> (Ref. KaVo: 1.007.8903)	Llave Doble Ref.: 30-604  <b>28'00€</b>

**Modelos para KaVo®**

**Relacionados**





 <p>Imagen no disponible</p>	<p>MASTERtorque mini® M8900L</p> <p><b>Ref.: 49-812</b></p> <p><b>56'80€</b></p>	<p><b>BAJO PEDIDO</b></p>
 <p>Imagen no disponible</p>	<p>MASTERtorque mini® M8700L</p> <p><b>Ref.: 49-813</b></p> <p><b>56'80€</b></p>	<p><b>BAJO PEDIDO</b></p>

**Tapas compatibles turbinas Bien Air®**

**RUMAR**

**Modelos para Bien Air®**

**Relacionados**



 <p><b>3 piezas</b></p>	<p>Bora S36-L Rotamax L (3 piezas)</p> <p><b>Ref.: 44-2468</b></p> <p><b>38'00€</b></p>	<p>Llave Doble Ref.: 49-802</p>
 <p><b>1 pieza, NO separable</b></p>	<p>Bora S36-L Rotamax L</p> <p><b>Ref.: 34-2469</b></p> <p><b>54'80€</b></p>	<p>Llave Doble Ref.: 49-802</p>
 <p><b>3 piezas</b></p>	<p>Croma Black Pearl Boralina</p> <p>Eolia S25-L</p> <p><b>Ref.: 34-2459</b></p> <p><b>48'00€</b></p>	<p>Llave Doble Ref.: 49-802</p>
	<p>Prestige</p> <p><b>Ref.: 49-651</b></p> <p><b>54'80€</b></p>	<p>Llave Ref.: 49-803</p>







**Tapas compatibles turbinas Siemens® / Sirona®**

**RUMAR**

**Modelos para Siemens® / Sirona®**



**Relacionados**

	<p>TM1 TS1 TS2</p> <p>4000ML 4000M 4000SL</p> <p>4000S Siemens T1 Control</p> <p><b>Ref.: 34-4000</b></p> <p><b>56'80€</b></p>	
	<p>T1 Control (con rebaje) TC3 Control</p> <p><b>Ref.: 41-210</b> (Ref. Sirona: 3327595 / 5828871)</p> <p><b>32'80€</b></p>	<p>Llave Ref.: 30-592</p>

Modelos para Siemens® / Sirona®		Descripción
	T2 Control T1 Control (sin rebaje)	Llave Ref.: 30-591  <b>Ref.: 41-211</b> (Ref. Sirona: 6000884) <b>32<sup>80</sup>€</b>
	T3 Racer (N/S>600.000) T4 Racer (N/S>600.000)	Llave Ref.: 30-612  <b>Ref.: 41-212</b> <b>32<sup>80</sup>€</b>
	T2 mini (600.000<N/S<700.000) T3 mini (600.000<N/S<700.000) T2 mini (700.000<N/S<800.000) T3 mini (700.000<N/S<800.000)	Llave Ref.: 30-592  <b>Ref.: 41-213</b> <b>32<sup>80</sup>€</b>
	Racer (todas) Siroboost	Llave Ref.: 30-591  <b>Ref.: 41-205</b> (Ref. Sirona: 58 28 897) <b>32<sup>80</sup>€</b>
	T1 mini T2 mini	T3 mini Incluye arandela  <b>Ref.: 34-8575</b> (Ref. Sirona: 4178575) <b>32<sup>80</sup>€</b>
	T1 Boost (N/S>600.000) T2 Boost (N/S>600.000) T3 Boost (N/S>600.000)	Llave Ref.: 30-612  <b>Ref.: 49-814</b> <b>32<sup>80</sup>€</b>
	T1 Boost (N/S>700.000) T2 Boost (N/S>700.000) T3 Boost (N/S>700.000)	<b>Ref.: 49-836</b> <b>56<sup>80</sup>€</b>

### Tapas compatibles turbinas W&H®











RUMAR

Modelos para W&H®		Relacionados
	Top Air 398 Top Air 698 Top Air 795 Top Air 798 Top Air 895	Top Air 898 Trend TC 80BC Trend TC-95BC Alegra TE-98 Alegra TE-95 (hasta 2009) Llave Ref.: 30-606  <b>Ref.: 30-4165</b> (Ref. W&H: 04232400) <b>32<sup>80</sup>€</b>
	Alegra TE-95 Alegra TE-98 Alegra TE-98 C LED (desde 2009)	Llave Ref.: 30-606  <b>Ref.: 34-9800</b> (Ref. W&H: 05489800) <b>56<sup>80</sup>€</b>





## Modelos para W&amp;H®

## Relacionados

	Alegra TE-95 Alegra TE-98 (hasta 2009)		
	<b>Ref.:</b> 34-9802	56 <sup>80</sup> €	
 <small>Imagen no disponible</small>	Alegra HS2014 TE-95 Alegra HS2014 TE-98		Llave Ref.: 49-829
	<b>Ref.:</b> 49-656	56 <sup>80</sup> €	
 <small>Imagen no disponible</small>	Alegra HS2014 TE-97		Llave Ref.: 30-610
	<b>Ref.:</b> 49-657	56 <sup>80</sup> €	
	<b>3 muescas</b> Synea TA-98C LED Synea TA-98 (desde 2007) Fusion TG-98	Vision TK-98	Llave Doble Ref.: 30-602
	<b>Ref.:</b> 30-4166 (Ref. W&H: 06446300)	32 <sup>80</sup> €	
	<b>3 muescas</b> Synea TA-97C LED Synea TA-97 (desde 2007)		Llave Doble Ref.: 30-602
	<b>Ref.:</b> 49-652 (Ref. W&H: 05183300)	56 <sup>80</sup> €	
	<b>2 muescas</b> Synea TA-98 (hasta 2009)		Llave Ref.: 49-840
	<b>Ref.:</b> 30-4168 (Ref. W&H: 03503000)	29 <sup>80</sup> €	
	Synea TA-96 (hasta 2009)		
	<b>Ref.:</b> 34-0096	56 <sup>80</sup> €	
 <small>Imagen no disponible</small>	Synea Vision TK-95		
	<b>Ref.:</b> 49-655	56 <sup>80</sup> €	BAJO PEDIDO
	Synea Vision TK-98		
	<b>Ref.:</b> 49-653	56 <sup>80</sup> €	BAJO PEDIDO
	Synea Vision TK-100		
	<b>Ref.:</b> 49-654	56 <sup>80</sup> €	

▶ Tapas compatibles turbinas **NSK®**

Modelos para NSK®		Relacionados
	TI-MAX X500 TI-MAX X500L  <b>Ref.: 41-223</b>	Tapa Doble Ref.: 30-605  <b>29'80€</b>
	TI-MAX X600 TI-MAX X600L  <b>Ref.: 41-224</b>	Tapa Doble Ref.: 30-600  <b>29'80€</b>
	TI-MAX X700 TI-MAX X700L  <b>Ref.: 41-225</b>	Tapa Doble Ref.: 30-605  <b>29'80€</b>
	TI-MAX Z900 TI-MAX Z900L  <b>Ref.: 34-8904</b>	Llave Doble Ref.: 30-614  <b>29'80€</b>
	TI-MAX Z800 TI-MAX Z800L  <b>Ref.: 34-8905</b>	Llave Doble Ref.: 30-614  <b>29'80€</b>
	S-MAX M500 S-MAX M500L  <b>Ref.: 41-226</b>	  <b>29'80€</b>
	S-MAX M600 S-MAX M600L S-MAX M900  <b>Ref.: 41-227</b>	S-MAX M900L Llave Doble Ref.: 30-632  <b>29'80€</b>
	TI-MAX A300 TI-MAX A300L MACH LITE S  <b>Ref.: 41-228</b>	MACH LITE XT S MACH QD-S MACH 2 S Llave Doble Ref.: 30-600  <b>56'80€</b>
	TI-MAX A600 TI-MAX A600L TI-MAX NL95  <b>Ref.: 41-229</b>	TI-MAX NL95 S TI-MAX NL45 S Llave Doble Ref.: 30-600  <b>56'80€</b>
	TI-MAX A400 TI-MAX A400L MACH LITE XT T  <b>Ref.: 41-230</b>	MACH QD-T MACH LITE T MACH 2 T  <b>56'80€</b>

NUEVO

**Modelos para NSK®**

**Relacionados**



Ti-MAX A700  
Ti-MAX A700L  
Ti-MAX NL95 T

Ti-MAX NL45 T

Ref.: **41-231**

**56<sup>80</sup>€**

Llave Doble Ref.: 30-600

▶ Tapas compatibles turbinas **TKD®**

RUMAR

**Modelos para TKD®**

**Relacionados**



Thera

Ref.: **40-421**

**48<sup>00</sup>€**

HASTA AGOTAR

▶ Tapas compatibles turbinas **Castellini®, Anthos® y Cefla®**

RUMAR

**Modelos para Castellini®, Anthos® y Cefla®**

**Relacionados**



Hi Power M  
Clean Air

Ref.: **49-801**

**54<sup>80</sup>€**

Llave Ref.: 49-800



Silent Power Gold  
Silent Power Gold M

Ref.: **49-811**

**54<sup>80</sup>€**

Llave Ref.: 49-810



Silent Power EVO 2  
Silent Power EVO 2L

Ref.: **49-825**

**54<sup>80</sup>€**

Silent Power EVO 4L  
Silent Power EVO 4LK

Llave Ref.: 49-822



Silent Power EVO Miniature  
Silent Power EVO Miniature K

Ref.: **49-826**

**54<sup>80</sup>€**

Llave Ref.: 49-823



Silent Power Silver 2  
Silent Power Silver 2L

Ref.: **49-827**

**54<sup>80</sup>€**

Silent Power Silver 4L  
Silent Power Silver 4LK

Llave Ref.: 49-824



▶ Tapas compatibles turbinas **Faro®**

RUMAR



Modelos para Faro®		Relacionados
	S400 S405  <b>Ref.: 49-25421</b>	<b>54'80€</b>







▶ Tapas turbinas **RUMAR®**

RUMAR

Modelos para RUMAR®		Relacionados
	PowerMax  <b>Ref.: 42-415</b>	<b>48'00€</b> <span style="background-color: yellow;">HASTA AGOTAR</span>
	ECO T1 ECO TLED2  <b>Ref.: 46-368</b>	<b>28'00€</b>
	ECO TLED1  <b>Ref.: 46-341T</b>	<b>28'00€</b>
	ECO T2 ECO T3 LED PRO T1  <b>Ref.: 58-250T</b>	<b>28'00€</b> <span>Llave Ref.: 58-252K</span>
	ECO TURBO COXO TITAN  <b>Ref.: 58-253T</b>	<b>28'00€</b> <span>Llave Ref.: 58-253K</span>

▶ Tapas compatibles turbinas **MK-dent®**

Modelos para MK-dent®		Relacionados
	HC4012 HC5022 HC6012 a partir serie F  <b>Ref.: 05-BC2022K</b>	<b>39'80€</b> <span style="background-color: yellow;">HASTA AGOTAR</span> <span>Llave Ref.: 05-KE1023T</span>
	HC4021 HC5021  <b>Ref.: 05-BC2021K</b>	<b>39'80€</b> <span style="background-color: yellow;">HASTA AGOTAR</span> <span>HC6021 a partir serie F HC7021 HE12</span>

Modelos para MK-dent®		Relacionados
	HP21 HP21 L HC21 HC21 L  <b>Ref.: 05-BC1051</b>	HC20 HC20 L HC8021 HC9021 (antigua 05-BC2041 y 05-BC1041)  <b>Llave Ref.: 05-KE1651T</b>  <b>39'80.€</b>
	HP22 HP22 L  <b>Ref.: 05-BC1042</b>	     <b>Llave Ref.: 05-KE1023T</b>  <b>39'80.€</b>
	HC8022 HC9022  <b>Ref.: 05-BC2042</b>	     <b>Llave Ref.: 05-KE1023T</b>  <b>39'80.€</b>
	HC2012 desde serie F HC4011  <b>Ref.: 05-BC2031</b>	      <b>Llave Ref.: 05-KE1023T</b>  <b>39'80.€</b>
	HE21 HE17 HE15  <b>Ref.: 05-BC1034</b>	HB21      <b>Llave Ref.: 05-KE1650T</b>  <b>39'80.€</b>
	HE22 HE14 HE18  <b>Ref.: 05-BC1035</b>	      <b>Llave Ref.: 05-KE1023T</b>  <b>39'80.€</b>

HASTA AGOTAR

HASTA AGOTAR

## TAPAS DE SPRAY TURBINA / DIFUSOR SPRAY

### Tapas de spray / difusor compatibles turbinas **KaVo®**

RUMAR

	Modelos para KaVo®	Observaciones
	HC4021 HC5021 HC7021  HC2022 HC6021 a partir serie G y otras triple spray  <b>Ref.: 44-8752</b> (Ref. KaVo: 0.553.8752)	<b>14'80€</b>
	HC4022 HC5022 HC6022  HC7022  <b>Ref.: 44-0833</b> (Ref. KaVo: 0.553.0833)	<b>16'80€</b>
	SUPERtorque® 650 SUPERtorque® 655 SUPERtorque® 660  <b>Ref.: 44-0573</b> (Ref. KaVo: 0.553.0573)	<b>19'80€</b>

### Tapas de spray / difusor spray compatibles turbinas **Bien Air®**

RUMAR

	Modelos para Bien Air®	Observaciones
	Bora ***Original Bien Air***  <b>Ref.: 30-162</b> (Ref. Bien Air: 131087 / 009.34.42)	<b>74'80€</b>

### Tapas de spray / difusor spray compatibles turbinas **RUMAR®**

RUMAR





	Modelos para RUMAR®	Observaciones
	PowerMax  <b>Ref.: 42-417</b>	Llave Ref.: 42-629  <span style="background-color: yellow; padding: 2px;">HASTA AGOTAR</span>

▶ Tapas de spray / difusor spray turbinas **MK-dent®**

	Modelos para MK-dent®	Observaciones
	HC4021 HC5021 HC7021  <b>Ref.: 44-8752</b>	HC2022 HC6021 a partir serie G y otras triple spray  <b>14'80€</b>
	HC4022 HC5022 HC6022  <b>Ref.: 44-0833</b>	HC7022  <b>16'80€</b>
	Tobera de spray turbinas líneas: HE HC HP  <b>Ref.: 05-SP0641</b>	<b>22'80€</b>

## TORNILLOS DE TAPA DE SPRAY / DIFUSOR SPRAY

▶ Tornillos de tapa de spray / difusor spray turbina **KaVo®**

	Modelos para KaVo®	Observaciones
	SUPERtorque® 630 SUPERtorque® 640  <b>Ref.: 44-3322</b> (Ref. KaVo: 0.553.3322)	Llave Ref.: 05-KE1022KT  <b>4'00€</b>
	SUPERtorque® 647 SUPERtorque® 645  <b>Ref.: 05-SP0440K</b> (Ref. KaVo: 0.553.0853)	Llave Ref.: 05-KE1022KT  <b>4'00€</b> <span style="background-color: yellow;">HASTA AGOTAR</span>
	SUPERtorque® 655 SUPERtorque® 660  <b>Ref.: 44-3391</b> (Ref. KaVo: 1.000.3391)	Llave Ref.: 05-KE1022KT  <b>5'80€</b>
	SUPERtorque® 650 B SUPERtorque® 650 C  <b>Ref.: 20-0543</b> (Ref. KaVo: 0.553.0543)	<b>20'80€</b> <span style="background-color: yellow;">HASTA AGOTAR</span>

## Tornillos de tapa de spray / difusor spray turbina Bien Air®

RUMAR

Modelos para MK-dent®		Observaciones
	Bora ***Original Bien Air***  <b>Ref.: 30-163</b> (Ref. KaVo: 131088 / 009.34.43)	<b>42'80€</b>

## Tornillos de tapa de spray turbina MK-dent®

RUMAR

Modelos para MK-dent®		Observaciones
	HC4021 HC5021 HC7021  <b>Ref.: 44-3322</b>	HC2022 HC6021 a partir serie G Otras triple spray  <b>4'00€</b>
	HC4022 HC5022 HC6022  <b>Ref.: 05-SP0440K</b>	HC7022  <b>4'00€</b>
	Líneas HP Líneas HC Líneas HE  <b>Ref.: 05-SP0630</b>	<b>3'80€</b>

Llave Ref.: 05-KE1022KT

Llave Ref.: 05-KE1022KT



HASTA AGOTAR

Llave Ref.: 05-KE1922

## OTROS REPUESTOS TURBINA

### Otros repuestos turbina



Descripción	Observaciones
 Bola universal turbinas para acople KaVo y Sirona.  <b>Ref.: 05-SP0417</b>	<b>1'20€</b> Medida: 1,5mm
 Muelle circular sistema acople KaVo Multiflex.  <b>Ref.: 05-SP0418</b>	<b>12'80€</b>
 Muelle circular sistema acople Sirona Click & Go.  <b>Ref.: 05-SP0418S</b>	<b>12'80€</b>







TODOS LOS REPUESTOS TURBINAS MK-dent® CONSULTE PRECIOS Y DESPIECES



## JUNTAS CONEXIÓN TURBINAS, ACOPLAMIENTOS Y MICROMOTORES

### Juntas Conexión Turbinas, Acoplamientos y Micromotores

**RUMAR**

	Descripción	Observaciones
	Conector micromotor Bien Air MC3  <b>Ref.: 40-011</b>	8 agujeros  <b>1'80€</b>
	Conector Midwest Lux  <b>Ref.: 44-310</b>	6 agujeros  <b>1'80€</b>
	Conector Midwest Lux 5  <b>Ref.: 44-311</b>	5 agujeros  <b>2'80€</b>
	Conector Midwest  <b>Ref.: 44-312</b>	4 agujeros  <b>1'80€</b>
	Conector Borden 3  <b>Ref.: 44-501</b>	3 agujeros  <b>2'00€</b>
	Conector Borden 2  <b>Ref.: 05-314</b>	2 agujeros  <b>1'80€</b>

**HASTA AGOTAR**

## LEDs Y BOMBILLAS XENON ROTATORIO

### LEDs RUMAR® para Rotatorio

RUMAR

Durabilidad: 5.000 horas

Tensión: 3 - 3,5 V CC/DC

	Descripción	Observaciones
	KaVo acoplamiento / micromotores. <b>Ref.: 33-001</b>	<b>29<sup>80</sup>€</b>
	Sirona acoplamiento / micromotores / Sirosonic L. <b>Ref.: 33-002</b>	<b>29<sup>80</sup>€</b>
	Bien Air, micromotores (MC2, MC3, MX y otras). <b>Ref.: 33-003</b>	<b>29<sup>80</sup>€</b>
	Bien Air, turbinas. <b>Ref.: 33-004</b>	<b>29<sup>80</sup>€</b>
	NSK acoplamiento NL / PTL. <b>Ref.: 33-005</b>	<b>29<sup>80</sup>€</b>
	NSK acoplamiento KCL / SCL, micromotor M40 y acoplamiento tipo Multiflex fabricado por NSK. <b>Ref.: 33-007</b>	<b>29<sup>80</sup>€</b>

### LEDs High Performance MK-dent® para Rotatorio

















Durabilidad: 5.000 horas

Temperatura color: 5.500 °K

Tensión: 3 - 3,5 V CC/DC

Potencia: 50.000 LUX

	Descripción	Observaciones
	KaVo / MK-dent, acoplamiento. <b>Ref.: 05-BU8012</b>	<b>Incluye:</b> Casquillo 05-SP0490 <b>38<sup>80</sup>€</b>
	KaVo, micromotores. <b>Ref.: 05-BU8012KM</b>	<b>38<sup>80</sup>€</b>
	Bien Air, micromotores. <b>Ref.: 05-BU8012BA</b>	<b>38<sup>80</sup>€</b>
	Bien Air, turbinas. <b>Ref.: 05-BU8012BAK</b>	<b>38<sup>80</sup>€</b>

	Descripción	Observaciones
	Sirona, micromotores. <b>Ref.: 05-BU8012SG</b>	38 <sup>80</sup> €
	Sirona, acoplamiento, ultrasonidos Sirosonic L y jeringa SprayvitL (Excepto TSI Siemens). <b>Ref.: 05-BU8012SB</b>	38 <sup>80</sup> €
	W&H / ADEC turbinas. <b>Ref.: 05-BU8012WH</b>	38 <sup>80</sup> €
	W&H Motor LT25. <b>Ref.: 05-BU8012WEA</b>	38 <sup>80</sup> €
	NSK acoplamiento NL / PTL. <b>Ref.: 05-BU8012N</b>	38 <sup>80</sup> €
	NSK micromotores NL (M40 NL400 / KCL6). <b>Ref.: 05-BU8012NNL</b>	38 <sup>80</sup> €
	NSK acoplamiento KCL / SCL, motor M40 y acoplamiento tipo Multiflex fabricado por NSK. <b>Ref.: 05-BU8012NM</b>	38 <sup>80</sup> €
	NSK micromotores TIM40 / TI205L. <b>Ref.: 05-BU8012NT</b>	38 <sup>80</sup> €
	Castellini, Turbinas, 1 pin. <b>Ref.: 05-BU8012C</b>	38 <sup>80</sup> €
	Micromotor MK-dent EM1190K. <b>Ref.: 05-BU8012EM</b>	38 <sup>80</sup> €
 <small>Imagen no disponible</small>	Micromotor MK-dent AM1006. <b>Ref.: 05-BU8012M1</b>	38 <sup>80</sup> €







## Bombillas Xenon Longlife MK-dent® para Rotatorio



**Durabilidad:** 300 horas

**Tensión:** 2,5 - 3 V CA/AC o CC/DC









	Descripción	Observaciones
	KaVo / MK-dent acoplamiento / micromotores. <b>Ref.: 05-BU7012</b>	12 <sup>80</sup> €

	Descripción	Observaciones
	Bien Air, micromotores. <b>Ref.: 05-BU7012BA</b>	<b>12'80€</b>
	Bien Air, turbinas. <b>Ref.: 05-BU7012BAK</b>	<b>12'80€</b>
	W&H, turbinas. <b>Ref.: 05-BU7012WH</b>	<b>12'80€</b>
	Sirona, acoplamiento. <b>Ref.: 05-BU7012SB</b>	<b>12'80€</b>
	Sirona, micromotores. <b>Ref.: 05-BU7012SG</b>	<b>12'80€</b>
	NSK, acoplamiento NL / PTL. <b>Ref.: 05-BU7012N</b>	<b>12'80€</b>

# ARANDELAS Y ANILLOS TÓRICOS TURBINAS



## Arandelas Turbinas







RUMAR

	Descripción	Observaciones
	Arandela <b>metálica</b> para turbinas KaVo 655, 660, 7000, 6000 trasera y compatibles. <b>***Original KaVo***</b> <b>Ref.: 45-5032</b> (Ref. KaVo: 1.001.5032)	<b>Medidas:</b> 4,9x6,35mm <b>1'80€</b>
	Arandela <b>metálica</b> para turbinas KaVo 8000, 9000 y delantero E680L y compatibles. <b>***Original KaVo***</b> <b>Ref.: 45-5900</b> (Ref. KaVo: 1.003.5900)	<b>1'80€</b>
	Arandela <b>metálica</b> para turbinas KaVo E680L trasera, S609, S619L y compatibles. <b>***Original KaVo***</b> <b>Ref.: 45-7576</b> (Ref. KaVo: 1.003.7576)	<b>Medidas:</b> 4,7x6,0x0,1mm <b>1'80€</b>
	Arandela <b>metálica</b> para turbinas KaVo 5000, 6000 delantera y compatibles. <b>***Original KaVo***</b> <b>Ref.: 45-6391</b> (Ref. KaVo: 1.001.6391)	<b>Medidas:</b> 4,7x6,0 mm <b>1'80€</b>
	Arandela <b>metálica</b> para turbinas W&H. (Excepto HS2014) <b>***Original W&amp;H***</b> <b>Ref.: 45-9408</b> (Ref. W&H: 02749408)	<b>1'80€</b>
 <small>Imagen no disponible</small>	Arandela <b>metálica</b> para turbinas Alegria HS2014 TE-95, Alegria HS2014 TE-97 y Alegria HS2014 TE-98 <b>Ref.: 45-2495</b>	<b>1'80€</b>
	Arandela <b>metálica</b> para turbinas Bien Air Bora, Black Pearl y compatibles. <b>Ref.: 45-2490</b>	<b>NO</b> Black Pearl ECO <b>1'30€</b>
 <small>Imagen no disponible</small>	Anillo de <b>Teflón</b> ancho turbinas Bien Air. <b>***Original Bien Air***</b> <b>Ref.: 30-160</b> (Ref. Bien Air: 009.34.52)	<b>Medidas:</b> 3,25x7,9mm <b>2'00€</b>
 <small>Imagen no disponible</small>	Anillo de <b>Teflón</b> fino turbinas Bien Air. <b>***Original Bien Air***</b> <b>Ref.: 30-161</b> (Ref. Bien Air: 009.34.56)	<b>Medidas:</b> 5,1x7,9mm <b>1'35€</b>

## Anillos tóricos rotores turbinas

RUMAR







	Descripción	Observaciones
	Rotores turbinas KaVo todos los modelos MK-dent todos los modelos. <b>Ref.: 30-140</b> (Ref. KaVo: 0.200.6172)	<b>1'80€</b>
	Rotores turbinas Sirona T1, Siroboost y compatibles. <b>Ref.: 30-151</b> (Ref. Sirona: 70 28 988 / 63 73 747)	<b>Medidas:</b> 1X6mm <b>1'80€</b>
	Rotores turbinas Sirona T2 Racer y compatibles <b>***Original Sirona***</b> <b>Ref.: 45-9416</b> (Ref. Sirona: 5829416)	<b>1'80€</b>

	Descripción	Observaciones
 <small>Imagen no disponible</small>	Rotores turbinas Bien Air. (Excepto Prestige)  <b>Ref.: 44-790</b> (Ref. Bien Air: 705.01.81)	1'00.€
	Rotores turbinas Bien Air Prestige grande. <b>***Original Bien Air***</b>  <b>Ref.: 30-791</b> (Ref. Bien Air: 705.02.35)	5'40.€
	Rotores turbinas Bien Air Prestige pequeño. <b>***Original Bien Air***</b>  <b>Ref.: 30-792</b> (Ref. Bien Air: 705.02.39)	4'00.€
	Rotores turbinas NSK X500 / 600 / 700.  <b>Ref.: 30-158</b>	1'00.€
	Rotores turbinas W&H. (Excepto HS2014 TE-95, HS2014 TE-97 y HS2014 TE-98)  <b>Ref.: 44-6001</b> (Ref. W&H: 01066001)	1'00.€
 <small>Imagen no disponible</small>	Rotores turbinas W&H HS2014 TE-95, HS2014 TE-97 y HS2014 TE-98  <b>Ref.: 30-141</b>	1'80.€

NUEVO

## Otros Anillos Tóricos Turbinas







RUMAR



	Descripción	Observaciones
	Unión cuerpo KaVo / MK-dent.  <b>Ref.: 05-SP0414</b>	1'30.€
	Tubo agua, KaVo.  <b>Ref.: 05-SP0415</b>	1'30.€
	Tubo aire KaVo / MK-dent.  <b>Ref.: 05-SP0416</b>	1'20.€
	Conector interno KaVo / MK-dent.  <b>Ref.: 05-SP0419</b>	1'20.€
	Tapa Spray KaVo 630 / 640 y 645. MK-dent todos los modelos excepto Prime Line.  <b>Ref.: 05-SP0442K</b> (Ref. KaVo: 0.200.6132)	1'20.€
	Tapa Spray KaVo 630 / 640 y 645. MK-dent todos los modelos excepto Prime Line.  <b>Ref.: 05-SP0443K</b> (Ref. KaVo: 0.200.6033)	1'20.€
 <small>Imagen no disponible</small>	Tapa Spray MK-dent Prime Line.  <b>Ref.: 05-SP0612</b>	Medidas: 6,3x0,3mm  1'00.€

	Descripción	Observaciones
 <small>Imagen no disponible</small>	Tapa Spray MK-dent Prime Line.  <b>Ref.: 05-SP0614</b>	<b>Medidas:</b> 7,5x0,45mm  <b>1'50€</b>
	Tapa Spray KaVo 647 / 650 / 655 / 6000 / 7000 y 8000.  <b>Ref.: 20-6176</b> (Ref. KaVo: 0.200.6176)	<b>Medidas:</b> 8,5x0,5mm  <b>4'20€</b>
	Difusor spray Bien Air Bora.  <b>Ref.: 30-164</b> (Ref. Bien Air: 1300431 / 705.02.50)	<b>3'00€</b>
 <small>Imagen no disponible</small>	Anillo tórico pequeño sistema acople NSK.  <b>Ref.: 05-SP0414NT</b>	<b>1'20€</b>
 <small>Imagen no disponible</small>	Anillo tórico grande sistema acople NSK.  <b>Ref.: 05-SP0412NT</b>	<b>1'20€</b>
	Kit completo, 5 anillos tóricos NSK.  <b>Ref.: 05-OR0411</b>	<b>6'50€</b>

## Anillos Tóricos Acoplamientos

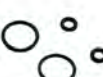

RUMAR

	Descripción	Observaciones
	Anillo grande acople KaVo / MK-dent.  <b>Ref.: 05-OR4011BK</b>	<b>1'20€</b>
	Anillo pequeño acople KaVo / MK-dent.  <b>Ref.: 05-OR4011WK</b>	<b>1'20€</b>
	Kit completo, 5 anillos tóricos Kavo Multiflex.  <b>Ref.: 05-OR4011</b>	<b>6'80€</b>
	Kit completo, 4 anillos tóricos Sirona Click & Go.  <b>Ref.: 31-000</b>	<b>5'50€</b>
	Kit completo, 3 anillos tóricos Bien Air Unifix.  <b>Ref.: 34-001</b>	<b>6'50€</b>
	Kit completo, 3 anillos tóricos W&H Roto-Quick.  <b>Ref.: 05-OR4012</b>	<b>4'80€</b>
	Kit completo, 4 anillos tóricos rm TopFlex y NSK PanaAir.  <b>Ref.: 05-307</b>	<b>4'80€</b>

	Descripción	Observaciones
 <small>Imagen no disponible</small>	Anillo tórico pequeño sistema acople NSK.  <b>Ref.: 05-SP0414NT</b>	<b>1'25€</b>
 <small>Imagen no disponible</small>	Anillo tórico grande sistema acople NSK.  <b>Ref.: 05-SP0412NT</b>	<b>1'30€</b>
	Kit completo, 5 anillos tóricos NSK.  <b>Ref.: 05-OR0411</b>	<b>6'50€</b>

► Anillos tóricos scalers y ultrasonidos

RUMAR











	Descripción	Observaciones
 <small>Imagen no disponible</small>	Kit completo, 7 anillos tóricos scaler ECO S2.  <b>Ref.: 44-ECOS2OR</b>	<b>9'80€</b>
	Anillo tórico conexión piezas de mano Woodpecker y DTE (6 uds.).  <b>Ref.: 28-166</b>	<b>3'80€</b>
	Anillo tórico piezas de mano Woodpecker y DTE (3 uds.).  <b>Ref.: 28-167</b>	<b>2'80€</b>

► Respuestos acoplamientos

RUMAR

	Descripción	Observaciones
 <small>Imagen no disponible</small>	Protector bombilla acoplamiento QC5016K y QC5016KW.  <b>Ref.: 05-SP0460</b>	<b>Válida para LED 06-BU7012</b>  <b>10'50€</b>
	Protector bombilla acoplamiento QC6016K y QC6016KW.  <b>Ref.: 05-SP0490</b>	<b>Válida para LED 06-BU8012</b>  <b>10'50€</b>
 <small>Imagen no disponible</small>	Protector bombilla acoplamiento QC5016SW.  <b>Ref.: 05-SP0460S</b>	<b>Válida para LED 05-BU8012SG</b>  <b>10'50€</b>
 <small>Imagen no disponible</small>	Protector bombilla acoplamiento QC6016SW.  <b>Ref.: 05-SP0491</b>	<b>Válida para LED 06-BU8012SB</b>  <b>10'50€</b>
 <small>Imagen no disponible</small>	Tubito entrada de aire acoplamiento Kavo / MK-dent.  <b>Ref.: 05-SP0461</b>	<b>3'00€</b> <span style="background-color: yellow;">HASTA AGOTAR</span>
 <small>Imagen no disponible</small>	Tubito salida de aire acoplamiento Kavo / MK-dent.  <b>Ref.: 05-SP0462</b>	<b>3'00€</b> <span style="background-color: yellow;">HASTA AGOTAR</span>



	Descripción	Observaciones
 <small>Imagen no disponible</small>	Tubito entrada de agua de spray acoplamiento Kavo / MK-dent.  <b>Ref.: 05-SP0464</b>	Medidas: 8,5x0,5mm  <b>2'50.€</b> <span style="float: right;">HASTA AGOTAR</span>
 <small>Imagen no disponible</small>	Tubo de aire de spray acoplamiento Kavo / MK-dent.  <b>Ref.: 05-SP0465</b>	<b>1'00.€</b> <span style="float: right;">HASTA AGOTAR</span>
 <small>Imagen no disponible</small>	Válvula agua spray acoplamiento Kavo / MK-dent.  <b>Ref.: 05-SP0466</b>	<b>12'50.€</b> <span style="float: right;">HASTA AGOTAR</span>
 <small>Imagen no disponible</small>	Anillo acoplamiento Kavo / MK-dent..  <b>Ref.: 05-SP0467</b>	<b>3'90.€</b> <span style="float: right;">HASTA AGOTAR</span>
 <small>Imagen no disponible</small>	Pin acoplamiento Kavo / MK-dent.  <b>Ref.: 05-SP0468</b>	<b>1'00.€</b> <span style="float: right;">HASTA AGOTAR</span>
 <small>Imagen no disponible</small>	Tornillo acoplamiento Kavo / MK-dent.  <b>Ref.: 05-SP0481</b>	<b>1'50.€</b> <span style="float: right;">HASTA AGOTAR</span>
 <small>Imagen no disponible</small>	Anillo tórico regulador acoplamiento KaVo / MK-dent.  <b>Ref.: 05-SP0483</b>	<b>1'20.€</b> <span style="float: right;">HASTA AGOTAR</span>
 <small>Imagen no disponible</small>	Muelle acoplamiento KaVo / MK-dent  <b>Ref.: 05-SP0482</b>	Igual a 05-SP1054  <b>1'00.€</b> <span style="float: right;">HASTA AGOTAR</span>
 <small>Imagen no disponible</small>	Piñón válvula acoplamiento KaVo / MK-dent.  <b>Ref.: 05-SP0484</b>	<b>4'80.€</b> <span style="float: right;">HASTA AGOTAR</span>
 <small>Imagen no disponible</small>	Bola para acoplamiento con regulación de agua KaVo / MK-dent  <b>Ref.: 05-SP0485</b>	<b>2mm</b> Igual a 05-SP1058  <b>1'00.€</b>

# RODAMIENTOS PARA CONTRA ÁNGULOS







Todos los rodamientos que ofrecemos están fabricados por los principales fabricantes de rodamientos a nivel mundial: **myonic**, **Barden**, **GRW**, **NMB**, **NHBB** o **ESI**. Todos fabricados de acuerdo a las normas de precisión ISO\* (normas para roda-



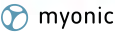
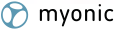

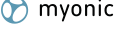

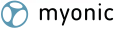
mientos de dimensiones métricas) y ABEC\*\* (rodamientos generalmente en dimensiones de pulgadas).



\* ISO: International Standard Organization.  
\*\* ABEC: Annular Bearing Engineers Conference.

## Rodamientos contra ángulos KaVo® RUMAR

Modelos para KaVo®			Descripción
	Delantero cabeza 67LH Delantero cabeza 68LH Delantero cabeza 2068CHC	Delantero cabeza 2068LHC Delantero cabeza L68 Delantero cabeza L67	Delantero cabeza C3  <b>Medidas:</b> 3x7x2,5/3,35mm <b>Especial</b> Liso Bola acero Abierto-Cerrado
	Trasero cabeza 67LH Trasero cabeza 68 LH Trasero cabeza 2068CHC	Trasero cabeza 2068LHC Trasero cabeza L68 Trasero cabeza L67	<b>Medidas:</b> 4x7x2mm Liso Bola acero Cerrado-Cerrado
	Delantero cabeza 67LDN Delantero cabeza 68LDN Delantero cabeza 67RIC		<b>Medidas:</b> 3x7x3mm Liso Bola acero Cerrado-Cerrado
	Trasero cabeza 67LDN Trasero cabeza 68LDN		<b>Medidas:</b> 4x7x2mm Liso Bola acero Abierto-Abierto
	Trasero cabeza 67RIC Trasero cabeza C3		<b>Medidas:</b> 5x8x2mm Liso Bola acero Sin retenedor Cerrado-Cerrado
	Cabeza 31LR Cabeza 52LDN Cabeza 671C	Cabeza 68G	<b>Medidas:</b> 3x6x2mm Liso Bola acero Cerrado-Cerrado
	20CN 20LN 20CH	20LH 2068CHC 2068LHC	2068C E20 E20L  <b>Medidas:</b> 3x8x3mm Liso Bola acero Cerrado-Cerrado
	Cabeza 24LN		<b>Medidas:</b> 4x7x2mm Liso Bola cerámica Torlon Abierto-Cerrado

Modelos para KaVo®			Observaciones
 myonic	25CH 25CHC 25CN 25LH	25LHS 25LN 25LS 25LHC	25LHD Trasero 25LP  <b>Medidas:</b> 4x7x2mm <b>Especial</b> Liso Bola cerámica Torlon Abierto-Cerrado
<b>Ref.: 45-325</b> (Ref. KaVo: 1.001.2836 / 0.220.1307)			<b>30<sup>80</sup>€</b>
 myonic	Delantero cabeza 25LP Delantero cabeza 25LPA		<b>Medidas:</b> 3,175x6,35x2,778mm <b>Especial</b> Liso Bola cerámica Torlon Abierto-Abierto
<b>Ref.: 45-317</b> (Ref. KaVo: 1.001.3167)			<b>30<sup>80</sup>€</b>
 GRW	Delantero cabeza E25L Delantero cabeza E25C		<b>Medidas:</b> 3,175x6,35x2,778mm <b>Especial</b> Liso Bola cerámica Torlon Abierto-Abierto
<b>Ref.: 45-320</b> (Ref. KaVo: 1.008.4038)			<b>30<sup>80</sup>€</b>
 GRW	Trasero cabeza E25L Trasero cabeza E25C		<b>Medidas:</b> 3,175x6,35x2,778mm <b>Especial</b> Liso Bola cerámica Torlon Abierto-Cerrado
<b>Ref.: 45-321</b> (Ref. KaVo: 1.008.4039)			<b>30<sup>80</sup>€</b>
 myonic	Eje 25LP Eje 25LPA Acoplador 25LP	Acoplador 25LPA Trasero eje E25L Trasero eje E25C	<b>Medidas:</b> 2x5x1,5mm Liso Bola acero Torlon Abierto-Abierto
<b>Ref.: 45-322</b> (Ref. KaVo: 1.001.2834)			<b>19<sup>80</sup>€</b>
 NMB	Acoplador E25L Acoplador E25C Acoplador 25LH Acoplador 25CH	Acoplador 25CHC Acoplador 25CN Acoplador 25LHS Acoplador 25LN	Acoplador 25LS Acoplador 25LHC Acoplador 25LHD  <b>Medidas:</b> 4x9x2,5mm <b>Especial</b> Liso Bola acero Abierto-Abierto
<b>Ref.: 45-323</b> (Ref. KaVo: 0.220.0171)			<b>16<sup>80</sup>€</b>
 myonic	Eje 25LH Eje 25CH Eje 25CHC Eje 25CN Eje 25LH Eje 25LHS Eje 25LN Eje 25LS Eje 25LHC Eje 25LHD	Engranaje Intermedio 25LH Engranaje Intermedio 25CH Engranaje Intermedio 25CHC Engranaje Intermedio 25CN Engranaje Intermedio 25LH Engranaje Intermedio 25LHS Engranaje Intermedio 25LN Engranaje Intermedio 25LS Engranaje Intermedio 25LHC Engranaje Intermedio 25LHD	Delantero eje E25L Delantero eje E25C  <b>Medidas:</b> 2,35x5x1,5mm Liso Bola acero Torlon Abierto-Abierto
<b>Ref.: 45-324</b> (Ref. KaVo: 0.220.0730)			<b>24<sup>80</sup>€</b>

Rodamientos contra ángulos **Bien Air®**

RUMAR

Modelos para Bien Air®		Descripción
 	Cabeza 1132 Trasero cabeza Serie Microseries  <b>Ref.: 45-301</b> (Ref. Bien Air: 701.01.81)	<b>Medidas:</b> 4x7x2mm Liso Bola acero Abierto-Abierto
 	Delantero cabeza Serie Microseries  <b>Ref.: 45-318</b>	<b>Medidas:</b> 5x8x2mm Liso Bola acero Sin retenedor Cerrado-Cerrado
 	Eje intermedio 1:1 Eje intermedio 1:4 Eje intermedio 1:5  <b>Ref.: 45-315</b> (Ref. Bien Air: 701.01.75)	<b>Medidas:</b> 2,35x4,763x2,35mm Liso Bola acero Cerrado-Cerrado

Rodamientos contra ángulos **Sirona®**

RUMAR

Modelos para Sirona®		Descripción
 	Delantero cabeza T1 Line C40 Delantero cabeza T1 Line C40L  <b>Ref.: 45-307</b>	<b>Medidas:</b> 3x7x2mm Liso Bola acero Abierto-Abierto
 	Trasero cabeza T1 Line C40 Trasero cabeza T1 Line C40L  <b>Ref.: 45-309</b>	<b>Medidas:</b> 4x7x2mm Liso Bola acero Torlon Abierto-Cerrado
 	Delantero T2 REVO  <b>Ref.: 45-305</b>	<b>Medidas:</b> 3x6x2mm Liso Bola acero Cerrado-Cerrado
 	Trasero T2 REVO  <b>Ref.: 45-300</b>	<b>Medidas:</b> 4x7x1,6mm Liso Bola acero Abierto-Abierto





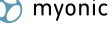







Rodamientos contra ángulos **W&H®**

RUMAR

Modelos para W&H		Descripción
 	Cabeza WA-56 LT nuevo Cabeza WA-56A nuevo  <b>Ref.: 45-300</b> (Ref. W&H: 05039400)	<b>Medidas:</b> 4x7x1,6mm Liso Bola acero Abierto-Abierto

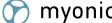
## Modelos para W&amp;H®

## Observaciones





 	<p>Cabeza WE99 LED-G Cabeza WE99A Cabeza WE99E</p> <p><b>Ref.: 45-326</b> (Ref. W&amp;H: 02649400 / 04486000)</p>	<p><b>Medidas:</b> 4x7x2mm</p> <p><b>Especial</b> Liso Bola cerámica Torlon Abierto-Abierto</p> <p><b>29<sup>80</sup>€</b></p>
 	<p>Cabeza WA-56LT      Cabeza 966LX      Cabeza 988E Cabeza WA-56A      Cabeza 975E      Cabeza 988E-KM Cabeza WA-66LT      Cabeza 975A      Cabeza WE-56 LED G Cabeza WA-66A      Cabeza 975LT      Cabeza WS-75E Cabeza WA-86LT      Cabeza 975LX      Cabeza WS-75KM Cabeza WA-86A      Cabeza 985E      Friatec 90 Cabeza A956E      Cabeza 985A      Friatec 5040 Cabeza A956A      Cabeza 985LT      Delantero y medio acople WS-75E Cabeza A956LT      Cabeza 985LX      Delantero y medio acople WS-75KM Cabeza A956LX      Cabeza 986E Cabeza 966E      Cabeza 986A Cabeza 966A      Cabeza 986LT Cabeza 966LT      Cabeza 986LX</p> <p><b>Ref.: 45-301</b> (Ref. W&amp;H: 01589600)</p>	<p><b>Medidas:</b> 4x7x2mm</p> <p>Liso Bola acero Abierto-Abierto</p> <p><b>14<sup>80</sup>€</b></p>
 	<p>Cabeza WS-75E Cabeza WS-75KM Cabeza WI75</p> <p><b>Ref.: 45-309</b> (Ref. W&amp;H: 04027300)</p>	<p><b>Medidas:</b> 4x7x2mm</p> <p><b>Especial</b> Liso Bola acero Torlon Abierto-Cerrado</p> <p><b>32<sup>80</sup>€</b></p>
 	<p>Pieza intermedia WA-56LT      Pieza intermedia WA-66LT      Pieza intermedia WA-86A Pieza intermedia WA-56A      Pieza intermedia WA-66A      Pieza intermedia WS-75E Pieza intermedia WA56LT nuevos      Pieza intermedia WA-67LT      Pieza intermedia WS-75KM Pieza intermedia WA-62LT      Pieza intermedia WA-67A Pieza intermedia WA-62A      Pieza intermedia WA-86LT</p> <p><b>Ref.: 45-306</b> (Ref. W&amp;H: 01579300 / 04733900)</p>	<p><b>Medidas:</b> 2,35x5,5x2mm</p> <p>Liso Bola acero Acero Abierto-Abierto</p> <p><b>13<sup>80</sup>€</b></p>
 	<p>Pieza intermedia WA-99 Pieza intermedia WA-969 Pieza intermedia WA-999</p> <p><b>Ref.: 45-308</b> (Ref. W&amp;H: 01579600)</p>	<p><b>Medidas:</b> 2,35x5,5x2mm</p> <p>Liso Bola acero Torlon Abierto-Abierto</p> <p><b>19<sup>80</sup>€</b></p>
 	<p>Delantero eje WA-56LT      Delantero eje WA-86A      Delantero eje WD-73 Delantero eje WA-56A      nuevos y antiguos      Delantero eje WD-74 Delantero eje WA-62LT      Delantero eje WD-56      Delantero eje WD-74 Delantero eje WA-62A      Delantero eje WD-57      Delantero eje HD-43 Delantero eje WA-66LT      Delantero eje WD-58      Delantero eje HP-44 Delantero eje WA-66A      Delantero eje WD-64      Delantero eje WS-75E Delantero eje WA-67LT      Delantero eje WD-66 Delantero eje WA-67A      Delantero eje WD-71 Delantero eje WA-86LT      Delantero eje WD-72</p> <p><b>Ref.: 45-307</b> (Ref. W&amp;H: 01589400)</p>	<p><b>Medidas:</b> 3x7x2mm</p> <p>Liso Bola acero Abierto-Abierto</p> <p><b>12<sup>80</sup>€</b></p>
 	<p>Trasero eje WA-56LT      Trasero eje WA-86A      Trasero eje WD-73 Trasero eje WA-56A      nuevos y antiguos      Trasero eje WD-74 Trasero eje WA-62LT      Trasero eje WD-56      Trasero eje HD-43 Trasero eje WA-62A      Trasero eje WD-57      Trasero eje HP-44 Trasero eje WA-66LT      Trasero eje WD-58      Trasero eje WS-75E Trasero eje WA-66A      Trasero eje WD-64      Trasero eje WS-75KM Trasero eje WA-67LT      Trasero eje WD-66 Trasero eje WA-67A      Trasero eje WD-71 Trasero eje WA-86LT      Trasero eje WD-72</p> <p><b>Ref.: 45-302</b> (Ref. W&amp;H: 01577000)</p>	<p><b>Medidas:</b> 3x10x4mm</p> <p>Liso Bola acero Abierto-Abierto</p> <p><b>12<sup>20</sup>€</b></p>

## Rodamientos contra ángulos NSK®

RUMAR

## Modelos para NSK®

## Descripción



 myonic	Cabeza T125 Cabeza X95 Cabeza X95L  Cabeza X85 Cabeza X85L  <b>Ref.: 45-326</b>	<b>Medidas:</b> 4x7x2mm <b>(Especial)</b> Liso Bola cerámica Torlon Abierto-Abierto	29'80€
 myonic	Cabeza SG20  <b>Ref.: 45-309</b>	<b>Medidas:</b> 4x7x2mm Liso Bola acero Torlon Abierto-Cerrado	32'80€
 GRW	Trasero Ti-Max X-SG20L 20:1  <b>Ref.: 45-318</b>	<b>Medidas:</b> 5x8x2mm Liso Bola acero Sin retenedor Cerrado-Cerrado	16'80€
 GRW	SG20  <b>Ref.: 45-306</b>	<b>Medidas:</b> 2,35x5,5x2mm Liso Bola acero Acero Abierto-Abierto	13'80€
 myonic	SG20  <b>Ref.: 45-308</b>	<b>Medidas:</b> 2,35x5,5x2mm Liso Bola acero Acero Abierto-Abierto	19'80€

## Rodamientos contra ángulos MK-dent®

RUMAR

## Modelos para MK-dent®





## Descripción

 myonic	Delantero cabeza LS9011 Delantero cabeza LS9021 Delantero cabeza LCH11  Delantero cabeza LCH21 Delantero cabeza LPH11 Delantero cabeza LPH21	<b>Medidas:</b> 3x7x2,5/3,35mm <b>Especial</b> Liso Bola acero Abierto-Cerrado	18'90€
 myonic	Trasero cabeza LS9011 Trasero cabeza LS9021 Trasero cabeza LCH11  Trasero cabeza LCH21 Trasero cabeza LPH11 Trasero cabeza LPH21	<b>Medidas:</b> 4x7x2mm Liso Bola acero Cerrado-Cerrado	16'10€
 myonic	LS2011 LS2011L LS3011  LS3011L LP11L	<b>Medidas:</b> 3x8x3mm Liso Bola acero Cerrado-Cerrado	11'80€

# RODAMIENTOS PIEZAS DE MANO

## Rodamientos piezas de mano **KaVo®**

RUMAR



Modelos para KaVo®		Descripción
 myonic	Trasero 10CN Trasero 10LN Trasero 10CH  Trasero 10LC Trasero 10CHC Trasero 10A (NO 10C)	<b>Medidas:</b> 4x9x4mm Liso Bola acero Cerrado-Cerrado  <b>Ref.: 45-5014</b> (Ref. KaVo: 0.220.1301 / 0.220.0103)
 NMB	Trasero 10C	<b>Medidas:</b> 5x11x5mm Liso Bola acero Cerrado-Cerrado  <b>Ref.: 45-200</b> (Ref. KaVo: 0.220.0126)
 myonic	10CH 10LC 10CHC  10CN 10LN 10C (Confirmar alto previamente)	<b>Medidas:</b> 5x8x3mm Liso Bola acero Cerrado-Cerrado  <b>Ref.: 30-7185</b> (Ref. KaVo: 0.220.1302)
 myonic	Delantero 15CN Series	<b>Medidas:</b> 5x9,525x3,175mm <b>Especial</b> Liso Bola acero Cerrado-Cerrado  <b>Ref.: 45-303</b> (Ref. KaVo: 0.220.1306)
 myonic	Trasero 15CN Series	<b>Medidas:</b> 4x9x4mm <b>Especial</b> Liso Bola acero Cerrado-Cerrado  <b>Ref.: 45-304</b> (Ref. KaVo: 0.220.1301)

## Rodamientos piezas de mano **Bien Air®**



RUMAR

Modelos para Bien Air®		Descripción
 GRW	Trasero 1:1 (Ref.: 160.03.83)	<b>Medidas:</b> 3x10x4mm Liso Bola acero Abierto-Abierto  <b>Ref.: 45-302</b> (Ref. Bien Air: 701.01.65)
 myonic	Delantero 1:1 (Ref.: 160.03.83)	<b>Medidas:</b> 5x8x3mm Liso Bola acero Cerrado-Cerrado  <b>Ref.: 30-7185</b> (Ref. Bien Air: 701.01.53)



**Rodamientos piezas de mano W&H®** RUMAR

Modelos para W&H®		Descripción
 <p>GRW</p>	Trasero S11 Trasero Synea HA43A  <b>Ref.: 45-302</b>	<b>Medidas:</b> 3x10x4mm Liso Bola acero Abierto-Abierto
 <p>myonic</p>	Delantero WH S11 Delantero Synea HA43A  <b>Ref.: 30-7185</b>	<b>Medidas:</b> 5x8x3mm Liso Bola acero Cerrado-Cerrado

**Rodamientos piezas de mano NSK®** RUMAR

Modelos para NSK®		Descripción
 <p>RUMAR</p>	Trasero EX5                      Trasero EX9 Trasero EX6                      Trasero EX12 Trasero EX7                      Trasero IS65 Trasero EX8  <b>Ref.: 45-313</b> (Ref. NSK: B10321-1005)	<b>Medidas:</b> 5x10x3mm Liso Bola acero Abierto-Abierto
 <p>ISC</p>	Trasero X65 Trasero X65L  <b>Ref.: 45-328</b> (Ref. NSK: B11223-1005)	<b>Medidas:</b> 5x10x4mm Liso Bola acero Cerrado-Cerrado
 <p>RUMAR</p>	Delantero EX5                      Delantero EX9 Delantero EX6                      Delantero EX12 Delantero EX7                      Delantero IS65 Delantero EX8  <b>Ref.: 45-314</b> (Ref. NSK: B13213-0804)	<b>Medidas:</b> 4x8x3mm Liso Bola acero Cerrado-Cerrado



**Rodamientos piezas de mano RUMAR®** RUMAR

Modelos para RUMAR®		Descripción
 <p>RUMAR</p>	Trasero ECO P1  <b>Ref.: 45-313</b>	<b>Medidas:</b> 5x10x3mm Liso Bola acero Abierto-Abierto
 <p>RUMAR</p>	Delantero ECO P1  <b>Ref.: 45-314</b>	<b>Medidas:</b> 4x8x3mm Liso Bola acero Cerrado-Cerrado



Rodamientos piezas de mano **MK-dent®**

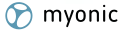

RUMAR

Modelos para MK-dent®		Descripción
 	Trasero LS1011  <b>Ref.: 45-5014</b>	<b>Medidas:</b> 4x9x4mm Liso Bola acero Cerrado-Cerrado  <b>16'60€</b>
 	Delantero LS1011  <b>Ref.: 30-7185</b>	<b>Medidas:</b> 5x8x3mm Liso Bola acero Cerrado-Cerrado  <b>16'80€</b>

## RODAMIENTOS MICROMOTORES NEUMÁTICOS

Rodamientos micromotores **KaVo®**

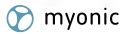

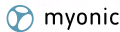
RUMAR

Modelos para KaVo®		Descripción
 	181M  <b>Ref.: 05-BE9023</b> (Ref. KaVo: 0.220.0021)	<b>Medidas:</b> 3x7x2mm Liso Bola acero Abierto-Abierto  <b>24'80€</b>
 	181M  <b>Ref.: 45-310</b> (Ref. KaVo: 0.220.0021)	<b>Medidas:</b> 3x7x2mm Liso Bola acero Abierto-Abierto  <b>24'80€</b>

HASTA AGOTAR

Rodamientos micromotores **W&H®**

RUMAR

Modelos para W&H®		Descripción
 	A25 E25 LT25  <b>Ref.: 30-133</b> (Ref. W&H: 01850600)	<b>Medidas:</b> 3,175x7,938x3,571mm Liso Bola acero Cerrado-Cerrado  <b>12'20€</b>

Rodamientos micromotores **NSK®**

RUMAR

Modelos para NSK®		Descripción	
 RUMAR	EX103	IS205	EX203C
	EX203	TI205	
	MX200	PTL950TI	
	EX100	TI205L	
Ref.: <b>45-311</b> (Ref. NSK: B22227-7923)		<b>14<sup>60</sup>€</b> Medidas: 2,38x7,938x3,571mm Liso Bola acero Cerrado-Cerrado	









Rodamientos micromotores **MK-dent®**

Modelos para MK-dent®		Descripción	
 myonic	AM1014	<b>24<sup>80</sup>€</b> Medidas: 3x7x2mm Liso Bola acero Abierto-Abierto	
	Ref.: <b>05-BE9023</b>		

# ROTORES CONTRA ÁNGULOS

Rotores compatibles contra ángulos **KaVo®**

RUMAR

	Modelos para KaVo®	Relacionados
	68LH L68  <b>Ref.: 44-705</b> (Ref. KaVo: 0.540.3661)	Eje Ref.: 44-724 Tapa Ref.: 44-704  <b>94<sup>80</sup>€</b>
	67LH L67 67LHB  E15L E15C 0767LHC  0767CHC  <b>Ref.: 44-468</b> (Ref. KaVo: 0.540.3671)	Eje Ref.: 44-398 Tapa Ref.: 44-704  <b>99<sup>80</sup>€</b>
	68LDN  <b>Ref.: 44-720</b> (Ref. KaVo: 0.540.2491)	Eje Ref.: 44-724 Tapa Ref.: 44-711  <b>84<sup>80</sup>€</b>
	C3 CL3  <b>Ref.: 44-414</b> (Ref. KaVo: 1.001.4490)	Eje Ref.: 44-402 Tapa Ref.: 44-401  <b>128<sup>00</sup>€</b>
	25CH 25CN 25LH  25LHC 24LN 24LS  <b>Ref.: 45-370K</b> (Ref. KaVo: 0.553.7341 / 0.553.5761)	Eje Ref.: 44-460 Segundo Eje Ref.: 44-462  <b>180<sup>00</sup>€</b>
	E25L E25C  <b>Ref.: 45-372K</b> (Ref. KaVo: 1.008.4040)	Eje Ref.: 44-449 Tapa Ref.: 44-446  <b>198<sup>00</sup>€</b>
	25LP 25LPA 200XD  200XDR  <b>Ref.: 45-371K</b> (Ref. KaVo: 1.001.3520 / 1.002.6135)	Eje Ref.: 44-461  <b>180<sup>00</sup>€</b>
	MASTERmatic Lux M25L  <b>Ref.: 44-424</b> (Ref. KaVo: 1.011.0129)	Eje Ref.: 44-448 Tapa Ref.: 44-447  <b>188<sup>00</sup>€</b>
	Piñón transmisión 1:1 para: 68LH L68  <b>Ref.: 44-701</b> (Ref. KaVo: 0.540.4012)	   <b>37<sup>80</sup>€</b>

Modelos para KaVo®		Relacionados	
	Piñón transmisión 1:1 para: 68LDN  <b>Ref.: 44-710</b> (Ref. KaVo: 0.540.4092)	<b>44'80€</b>	
	Piñón reducción 2:1 para: 67LH L67  <b>Ref.: 44-721</b> (Ref. KaVo: 0.540.4022)	<b>38'80€</b>	
	67RIC <b>***Original KaVo***</b>  <b>Ref.: 20-808</b> (Ref. KaVo: 0.540.2791)	<b>165'80€</b>	HASTA AGOTAR
	Corona para: 67RIC <b>***Original KaVo***</b>  <b>Ref.: 20-805</b> (Ref. KaVo: 0.540.2761)	<b>101'80€</b>	HASTA AGOTAR

### Rotores compatibles contra ángulos Bien Air®









RUMAR

Modelos para Bien Air®		Relacionados	
	1:5 1:5L  <b>Ref.: 44-438</b> (Ref. Bien Air: 1501933)	<b>128'00€</b>	Incluye: arandela metal + 2 anillos tóricos  Eje Ref.: 44-437 Tapa Ref.: 44-445
	1:1 1:1L  <b>Ref.: 45-377B</b> (Ref. Bien Air: 1501085)	<b>98'00€</b>	Eje Ref.: 45-378B Tapa Ref.: 44-0550
	20:1 20:1L  <b>Ref.: 44-428</b>	<b>98'00€</b>	Eje Ref.: 44-429 Tapa Ref.: 44-430

### Rotores compatibles contra ángulos Sirona®

RUMAR











Modelos para Sirona®			Relacionados
	T1 Line C200 (N/S>30 000) T1 Line C200L (N/S>43 000 / N/S>65 000) T1 Classic S200L (N/S<32 001)	T2 Line A200L (N/S<7804 / N/S>7805) T2 Line A170L T3 Line E20 (N/S<2325 / N/S>2326) T3 Line E200L (N/S<2325 / N/S>2326)	T2 Line A200 (N/S<7804   N/S>7805) A200L (N/S<32 001) A170L T3 Line E200 (N/S<2325 / N/S>2326)
<b>Ref.: 45-375S</b> (Ref. Sirona: 6175587 / 6405687)	<b>238'00€</b>	<b>Cabeza standard</b> <b>Rodamientos:</b> 3,175x7x2mm  Eje Ref.: 44-451 Tapa Ref.: 44-407	

Modelos para Sirona®			Relacionados
	T1 Line C40 T1 Line C40L T2 Line A40 T2 Line A40L	T3 Line E40 T1 Classic S40	<b>Cabeza standard</b>  Eje Ref.: 44-418 Tapa Ref. A40: 44-409 Tapa Ref. C40: 44-408
	<b>Ref.: 44-417</b> (Ref. Sirona: 6000983)		<b>Wow!!</b> <b>88<sup>00</sup>€</b>
	T1 Line C40 T1 Line C40L T2 Line A40 T2 Line A40L	T3 Line E40 T1 Classic S40	<b>Cabeza standard</b>
	<b>Ref.: 05-SP2005S</b> (Ref. Sirona: 6000983)		<b>108<sup>00</sup>€</b>
	T1 Classic S200L (N/S>32 002) T1 Classic S200L (N/S>202 000) T1 Line C200L (N/S>68 381) T1 Line C200L (N/S<302 000 y N/S>202 000) T1 Line C200L (N/S>302 000)	T2 Line A200L (N/S>202 000 y N/S<302 000) T2 Line A200L (N/S>302 000) T3 Line E200 (N/S>202 000) T3 S-Line ES200 T2 S-Line AS200L	<b>Rodamientos:</b> 3,175x6x2mm  Eje Ref.: 44-451 Tapa Ref.: 44-410
	<b>Ref.: 44-444</b> (Ref. Sirona: 6414457 / 6562586)		<b>138<sup>00</sup>€</b>
	Dentsply X-Smart Plus 6:1		Eje Ref.: 44-432 Tapa Ref.: 44-433
	<b>Ref.: 44-431</b>		<b>88<sup>00</sup>€</b>
	Dentsply X-Smart 16:1		Eje Ref.: 44-435 Tapa Ref.: 44-436
	<b>Ref.: 44-434</b>		<b>68<sup>80</sup>€</b>
	T2 Revo Mini R40 T1 Line C40/C40L mini T2 S-Line AS40L T3 S-Line ES40	T3 Line E40 (SN>202 000) T2 Line A40 (SN>202 000) T1 Classic S40L (SN>30 000 & >202 000)	T1 Line C40L (SN>65 000 & >202 000) T1 Line C40/C40L 1:1 8,7 cabeza mini
	<b>Ref.: 44-416</b> (Ref. Sirona: 5943092 / 6049352 / 6405695)		<b>Rodamiento trasero:</b> 4x7x1,6mm  Eje Ref. R40: 44-421 Eje Ref. A40: 44-418 Eje Ref. C40 mini: 44-418
			<b>98<sup>00</sup>€</b>
	T2 Revo Mini R40 T1 Line C40/C40L mini T2 S-Line AS40L T3 S-Line ES40	T3 Line E40 (SN>202 000) T2 Line A40 (SN>202 000) T1 Classic S40L (SN>30 000 & >202 000)	T1 Line C40L (SN>65 000 & >202 000) T1 Line C40/C40L 1:1 8,7 cabeza mini
	<b>Ref.: 44-452</b> (Ref. Sirona: 5943092 / 6049352 / 6405695)		<b>Rodamiento trasero:</b> 4x7x2mm  Eje Ref. R40: 44-421 Eje Ref. A40: 44-418 Eje Ref. C40 mini: 44-418
			<b>98<sup>00</sup>€</b>
	T1 Line Endo 6L		Eje Ref.: 44-470 Tapa Ref.: 44-471
	<b>Ref.: 44-469</b> (Ref. Sirona: 6535525)		<b>84<sup>80</sup>€</b>

## Rotores compatibles contra ángulos W&H®

RUMAR





Modelos para W&H®			Relacionados
	SURGICAL WS-75 LED G SURGICAL WS-75 E SURGICAL WS-75 KM (Confirmar con imagen)	SURGICAL WS-75 LG SURGICAL WI-75 E SURGICAL WI-75 KM	SURGICAL WI-75 LED G
	<b>Ref.: 44-399</b> (Ref. W&H: 04939900)		Eje Ref.: 44-381 Eje Ref.: 44-378 Tapa Ref.: 44-376
			<b>128<sup>00</sup>€</b>

	Modelos para W&H®	Relacionados
	<p>WS-75 E (01001 &lt; N/S &lt; 25335)            WS-75 KM (01001 &lt; N/S &lt; 25335)  <b>(Confirmar con imagen)</b></p> <p><b>Ref.: 44-453</b> (Ref. W&amp;H: 04651800)</p>	<p><b>***Necesario cambiar eje y tapa, contra ángulo antiguo***</b></p> <p>Eje Ref.: 44-415            Tapa Ref.: 44-376</p> <p><b>108'00€</b></p>
	<p>WE-56            WE-56 E            WA-56 A (antiguo)</p> <p><b>Ref.: 44-370</b> (Ref. W&amp;H: 03819000, 05843300)</p>	<p>Rodamientos: 2mm</p> <p>Eje Ref.: 44-374            Tapa Ref.: 44-379</p> <p><b>68'80€</b></p>
	<p>Alegra WE-56 LED G            Alegra WE-56 A</p> <p><b>Ref.: 44-443</b> (Ref. W&amp;H: 05844400)</p>	<p>Tapa Ref.: 44-379</p> <p><b>74'80€</b></p>
	<p>Piñón para:            Alegra WE-56            Alegra WE-56 E            Alegra WA-56 A (antiguo)</p> <p><b>Ref.: 44-371</b></p>	<p><b>39'80€</b></p>
	<p>Alegra WE-56            Alegra WE-56LT</p> <p><b>Ref.: 44-477</b> (Ref. W&amp;H: 07539000)</p>	<p><b>168'80€</b></p>
	<p>Alegra WE-99A            Alegra WE-99 LED G</p> <p><b>Ref.: 44-478</b> (Ref. W&amp;H: 05846100)</p>	<p><b>298'00€</b></p>
	<p>Synea WA-56 (desde 2007)            Synea WA-56LT (desde 2007)            Synea WA-66 (desde 2007)            Synea WA-66A (desde 2007)            Synea WA-66LT (desde 2007)</p> <p>Synea® Vision WK-56 (N/S-04013)            Synea® Vision WK-66 (N/S-01906)</p> <p><b>Ref.: 44-375</b> (Ref. W&amp;H: 05431100)</p>	<p>Rodamientos: 1,6mm</p> <p>Eje Ref.: 44-439            Tapa Ref.: 44-377</p> <p><b>68'80€</b></p>
	<p>Synea WA-99LT (desde 2007)</p> <p><b>Ref.: 44-427</b> (Ref. W&amp;H: 05220300)</p>	<p>Tapa Ref.: 44-413</p> <p><b>248'00€</b></p>
	<p>Fusion WG-99LT (SN &gt; 007802)            Vision WK-99LT (SN &gt; 01001)</p> <p><b>Ref.: 44-442</b> (Ref. W&amp;H: 07473400)</p>	<p>Eje Ref. <b>WG-99LT</b>: 44-440            Eje Ref. <b>WK-99</b>: 44-441</p> <p><b>248'00€</b></p>
	<p>Rotor completo y tapa botón para W&amp;H Trend WD-56</p> <p><b>Ref.: 44-426</b></p>	<p>Eje Ref.: 44-425            Tapa Ref.: 44-412</p> <p><b>80'00€</b></p>

Modelos para W&H®		Relacionados	
 Imagen no disponible	Synea WA-99LT (hasta 2007)  <b>Ref.: 44-479</b> (Ref. W&H: 04517200)	<b>298<sup>00</sup>€</b>	<b>BAJO PEDIDO</b>
 Imagen no disponible	Fusion WG-56LT (N/S<014633)  <b>Ref.: 44-481</b> (Ref. W&H: 06994300)	<b>178<sup>00</sup>€</b>	<b>BAJO PEDIDO</b>
 Imagen no disponible	Fusion WG-56LT (N/S<014634)  <b>Ref.: 44-480</b> (Ref. W&H: 07605900)	<b>178<sup>00</sup>€</b>	<b>BAJO PEDIDO</b>
 Imagen no disponible	Fusion WG-99LT (N/S<007801) Fusion WG-99 LED G (N/S<007801) Fusion WG-99A (N/S<001818)  <b>Ref.: 44-482</b> (Ref. W&H: 06993900)	<b>178<sup>00</sup>€</b>	<b>BAJO PEDIDO</b>

## Rotores compatibles contra ángulos NSK®



# RUMAR

Modelos para NSK®		Relacionados	
	Ti-Max Ti25 Ti-Max Ti25L Ti-Max Ti15  <b>Ref.: 44-380</b>	Ti-Max Ti15L  <b>68<sup>80</sup>€</b>	Eje Ref.: 44-396 Tapa Ref.: 44-387
	Ti-Max X95 Ti-Max X95L S-MAX M95  <b>Ref.: 44-384</b> (Ref. NSK: C600 015 / C600C015003 / C600C015002)	S-MAX M95L  <b>159<sup>80</sup>€</b>	Eje Ref. M95: 44-386 Tapa Ref. M95: 44-404  Eje Ref. X95: 44-385 Tapa Ref. X95: 44-423
	Ti-Max X25 Ti-Max X25L Ti-Max X15  <b>Ref.: 44-388</b> (Ref. NSK: C601 015 / C601015001)	Ti-MaxX15L S-Max M25 S-MaxM25L  <b>82<sup>80</sup>€</b>	Eje Ref. X25: 44-389  Eje Ref. M25: 44-390
	Ti-Max Z95 Ti-Max Z95L (Modelo antiguo)  <b>Ref.: 44-463</b>	<b>158<sup>00</sup>€</b>	Eje Ref.: 44-465 Tapa Ref.: 44-464
	Ti-Max Z95 Ti-Max Z95L (Modelo nuevo)  <b>Ref.: 44-466</b>	<b>158<sup>00</sup>€</b>	Eje Ref.: 44-465 Tapa Ref.: 44-467

Modelos para NSK®		Relacionados
	FX15 FX25 X23  <b>Ref.: 44-454</b> (Ref. NSK: C1052700)	Eje Ref.: 44-455 Tapa Ref.: 44-456  <b>58'00€</b>
	TI-MAX Z25 TI-MAX Z25L  <b>Ref.: 44-457</b>	Eje Ref.: 44-458 Tapa Ref.: 44-459  <b>84'80€</b>
	S-Max SG20 S-Max SG20L Ti-Max X-DSG20L Ti-Max X-SG20L  <b>Ref.: 44-394</b> (Ref. NSK: C1010150002 / C1010150001)	Incluye: arandela azul y arandela metálica  Eje Ref. S-MAX SG20: 44-395 Eje Ref. TI-MAX SG20: 44-422 Eje Ref. X-MAX SG20: 44-450 Tapa Ref.: 44-391  <b>98'00€</b>

### Rotores compatibles contra ángulos Castellini®

RUMAR

Modelos para Castellini®		Relacionados
 <small>Imagen no disponible</small>	Goldspeed EVO S1  <b>Ref.: 44-483</b>	Tapa Ref.: 44-485  <b>178'80€</b> <span style="background-color: green; color: white; padding: 2px;">BAJO PEDIDO</span>
	Goldspeed S1 Goldspeed SIL  <b>Ref.: 44-380</b>	Eje Ref.: 44-396 Tapa Ref.: 44-484  <b>68'80€</b>

### Rotores compatibles contra ángulos BA International®

RUMAR

Modelos para BA International®		Relacionados
	B.A40LSS B.A40SS B.A45LS B.A45SS  <b>Ref.: 44-417</b>	Eje Ref.: 44-421  <b>98'00€</b>

### Rotores contra ángulos WOODPECKER®



 WOODPECKER®

Modelos para WOODPECKER®		Relacionados
	20:1 WP-1L (IMPLANTER LED / DTE IMPLANT X LED)  <b>Ref.: 28-28037</b>	Eje Ref.: 28-28038 Tapa Ref.: 28-28039  <b>198'00€</b>



## Rotores contra ángulos MK-dent®



Modelos para MK-dent®		Relacionados	
	LCH11 LPH11 LS9011  <b>Ref.: 05-SP2005</b>	<b>114<sup>80</sup>€</b>	
 <small>Imagen no disponible</small>	LE15 LE15L  <b>Ref.: 05-SP1292M1</b>	<b>188<sup>00</sup>€</b>	<b>HASTA AGOTAR</b>
	LCH16 LS9016  <b>Ref.: 05-SP2205</b>	<b>148<sup>00</sup>€</b>	<b>HASTA AGOTAR</b> Fresas turbina

## EJES CONTRA ÁNGULOS

## Ejes compatibles contra ángulos KaVo®

RUMAR

Modelos para KaVo®		Relacionados	
	68LH L68 68LDN 68GDN  <b>Ref.: 44-724</b> (Ref. KaVo: 0.540.1151)	<b>48<sup>00</sup>€</b>	
	67LH 31LR L67 67LDN  <b>Ref.: 44-398</b> (Ref. KaVo: 0.540.1161)	<b>48<sup>00</sup>€</b>	
	Corona eje de transmisión para: 68LH 68LDN L68  <b>Ref.: 44-725</b>	<b>9<sup>80</sup>€</b>	
	Eje intermedio para: C3 CL3  <b>Ref.: 44-402</b> (Ref. KaVo: 1.003.4207)	<b>58<sup>00</sup>€</b>	
	20LH 20CH 2068CHC E20 2068LHC E20L  <b>Ref.: 05-SP1010</b> (Ref. KaVo: 0.534.0681)	<b>33<sup>10</sup>€</b>	

## Modelos para KaVo®

## Relacionados

	INTRAmatic 25LH INTRAmatic 25LHS INTRAmatic 25CN	INTRAmatic 25CH	
	<b>Ref.: 44-460</b> (Ref. KaVo: 0.553.7201)		<b>148<sup>00</sup>€</b>
	MASTERmatic Lux M25L		
	<b>Ref.: 44-448</b> (Ref. KaVo: 1.001.3515)		<b>149<sup>80</sup>€</b>
	E25L E25C		
	<b>Ref.: 44-449</b> (Ref. KaVo: 1.007.9916)		<b>158<sup>00</sup>€</b>
	GENTLEpower LUX 25LP GENTLEpower LUX 25LPA MASTERmaticLUX M25L		
	<b>Ref.: 44-461</b> (Ref. KaVo: 1.001.3515)		<b>148<sup>00</sup>€</b>
	Eje "segundo" GENTLEpower LUX 25LP Eje "segundo" GENTLEpower LUX 25LPA		
	<b>Ref.: 44-462</b> (Ref. KaVo: 1.001.3519)		<b>139<sup>80</sup>€</b>

PRECIO MÁS BAJO

## Ejes compatibles contra ángulos Bien Air®







RUMAR

## Modelos para Bien Air®

## Relacionados







	1:5 1:5L		
	<b>Ref.: 44-437</b> (Ref. Bien Air: 1500057)		<b>149<sup>80</sup>€</b>
	1:1		
	<b>Ref.: 45-378B</b> (Ref. Bien Air: 1500289)		<b>68<sup>00</sup>€</b>
	20:1 20:1L		
	<b>Ref.: 44-429</b>		<b>88<sup>00</sup>€</b>

Ejes compatibles contra ángulos **Sirona®**

	Modelos para Sirona®	Relacionados
	T1 Classic T1 Line T2 S-Line  <b>Ref.: 44-451</b> (Ref. Sirona: 6175603)	T3 Line  68'00€
	T1 Classic S40 T1 Line C40 T1 Line C40L  <b>Ref.: 44-418</b> (Ref. Sirona: 6000959)	T2 Line A40 T2 Line A40L  Cabeza standard  68'00€
	T2 Revo R40  <b>Ref.: 44-421</b> (Ref. Sirona: 5943167)	68'00€
	Dentsply X-Smart Plus 6:1  <b>Ref.: 44-432</b>	78'00€
	Dentsply X-Smart 6:1  <b>Ref.: 44-435</b>	Llave Ref: 49-833  68'00€
	T1 Line ENDO 6L  <b>Ref.: 44-470</b> (Ref. Sirona: 6535533)	68'00€



Ejes compatibles contra ángulos **W&H®**











	Modelos para W&H®	Relacionados
	WS-75 E WS-75 KM *modelo fabricado hasta 2008 (SN 01001 to 25335)  <b>Ref.: 44-415</b>	(Eje montaje atornillable)  Llave Ref: 44-950
	WI-75 LED G WS-75 (Confirmar con imagen)  <b>Ref.: 44-381</b>	WI-75 E WI-75 KM  (Eje montaje atornillable)  Llave Ref: 44-950
	WS-75 LED G  <b>Ref.: 44-378</b> (Ref. W&H: 06025100)	(Eje montaje NO atornillable)  108'00€

	Modelos para W&H®	Relacionados
	Alegra WE-56 Alegra WE-56E  <b>Ref.: 44-374</b> (Ref. W&H: 05852500)	<b>59'80€</b>
	Corona superior para eje: Alegra WE-56 Alegra WE-56E  <b>Ref.: 44-382</b>	<b>10'80€</b>
	Corona inferior para eje: Alegra WE-56 Alegra WE-56E  <b>Ref.: 44-383</b>	<b>10'80€</b>
	Synea WA-56 (desde 2007 / nuevo) Synea WA-56LT (desde 2007 / nuevo) Fusion WG-56LT (N/S 001001-014633)  <b>Ref.: 44-439</b> (Ref. W&H: 05233200)	<b>146'80€</b>
	Trend WD-56  <b>Ref.: 44-425</b>	<b>48'00€</b>  Llave Ref.: 44-950
 Imagen no disponible	Synea WA-99LT (desde 2007) Fusion WG-99LT (N/S 001001-007801) Fusion WG-99A (N/S 001001-001818)  <b>Ref.: 44-440</b> (Ref. W&H: 06420900)	<b>210'80€</b>  BAJO PEDIDO
 Imagen no disponible	Fusion WG-99LT (SN > 007802) Vision WK-99LT (SN > 01001)  <b>Ref.: 44-441</b> (Ref. W&H: 06579200)	<b>219'80€</b>  BAJO PEDIDO

Ejes compatibles contra ángulos **NSK®**

RUMAR

	Modelos para NSK®	Relacionados
	Ti-Max Ti25 Ti-Max Ti25L  <b>Ref.: 44-396</b>	<b>48'00€</b>
	Corona superior para eje Ti-Max Ti25  <b>Ref.: 44-392</b>	<b>10'80€</b>  Para usar con pasador  HASTA AGOTAR

	Modelos para NSK®	Relacionados
	Ti-Max X95 Ti-Max X95L  <b>Ref.: 44-385</b> (Ref. NSK: C600 022)	<b>108<sup>00</sup>€</b>
	S-Max M95 S-Max M95L  <b>Ref.: 44-386</b> (Ref. NSK: 10000559)	<b>118<sup>00</sup>€</b>
	Ti-Max X25 Ti-Max X25L  <b>Ref.: 44-389</b> (Ref. NSK: C601 022)	<b>48<sup>00</sup>€</b>
	S-Max M25 S-Max M25L  <b>Ref.: 44-390</b> (Ref. NSK: 1000574)	<b>48<sup>00</sup>€</b>
	Corona superior para eje: S-MAX M25 S-MAX M25L  <b>Ref.: 44-393</b>	<b>10<sup>80</sup>€</b> <span style="background-color: yellow; padding: 2px;">HASTA AGOTAR</span>
	S-Max SG20 S-Max SG20L  <b>Ref.: 44-395</b> (Ref. NSK: C1010022 / 10000229001)	<b>98<sup>00</sup>€</b> Llave Ref: 44-950
	Ti-Max X-SG20 Ti-Max X-Max SG20L  <b>Ref.: 44-422</b> (Ref. W&H: C1003022 / 10000255001)	<b>98<sup>00</sup>€</b> Llave Ref: 44-950
	Ti-Max X-Max X-DSG20L  <b>Ref.: 44-450</b> (Ref. W&H: C1068912)	<b>165<sup>80</sup>€</b> Llave Ref: 44-950
	FX15 FX25 FX23  <b>Ref.: 44-455</b> (Ref. W&H: C10000946)	<b>54<sup>80</sup>€</b>
	Ti-Max Z25 Ti-Max Z25L  <b>Ref.: 44-458</b>	<b>59<sup>80</sup>€</b>

**Modelos para NSK®**

**Relacionados**



Ti-Max Z95  
Ti-Max Z95L

Ref.: **44-465**

**164<sup>80</sup>€**

▶ Ejes compatibles contra ángulos **Castellini®**



**Modelos para Castellini®**

**Relacionados**



Goldspeed S1  
Goldspeed SIL

Ref.: **44-396**

**48<sup>00</sup>€**

▶ Ejes compatibles contra ángulos **BA International®**



**Modelos para BA International®**

**Relacionados**



BA45S  
BA40LSS  
BA40SS

BA45LS

Ref.: **44-421**

**68<sup>00</sup>€**

▶ Ejes contra ángulos **WOODPECKER®**



**Modelos para WOODPECKER®**

**Relacionados**



201 WP-1L  
(IMPLANTER LED / DTE IMPLANT X LED)

Rotor Ref.: 28-28037  
Tapa Ref.: 28-28039

Ref.: **28-28038**

**102<sup>80</sup>€**

▶ Ejes contra ángulos **MK-dent®**



**Modelos para MK-dent®**

**Relacionados**



LCH11  
LPH11

LS9011  
LS9016

Ref.: **05-SP2024**

**72<sup>80</sup>€**



LS2011  
LS2011L

Ref.: **05-SP1010**

**33<sup>10</sup>€**

## Modelos para MK-dent®

## Relacionados

 <p>Imagen no disponible</p>	<p>LE15 LE15L</p> <p><b>Ref.: 05-SP2246M1</b></p>	<p><b>148<sup>00</sup>€</b></p> <p><b>HASTA AGOTAR</b></p>
---	---	--





## TAPAS CONTRA ÁNGULOS

## Tapas compatibles contra ángulos KaVo®

RUMAR

## Modelos para KaVo®

## Observaciones

 <p>3 muescas</p>	<p>68LH 67LH L68</p> <p>L67</p> <p><b>Ref.: 44-704</b> (Ref. KaVo: 0.540.3741)</p>	<p>Llave Doble Ref.: 44-751</p> <p><b>25<sup>80</sup>€</b></p>
	<p>68LDN 68GDN 67LDN</p> <p><b>Ref.: 44-711</b> (Ref. KaVo: 0.540.2501)</p>	<p>Llave Doble Ref.: 44-751</p> <p><b>29<sup>80</sup>€</b></p>
	<p>C3 CL3</p> <p><b>Ref.: 44-401</b> (Ref. KaVo: 0.201.8958 + 0.540.3752 + 1.001.4486)</p>	<p>Llave Ref. : 49-832</p> <p><b>28<sup>00</sup>€</b></p>
	<p>E25L E25C</p> <p><b>Ref.: 44-446</b> (Ref. KaVo: 1.008.1488)</p>	<p>Llave Ref. : 49-819</p> <p><b>24<sup>80</sup>€</b></p>
	<p>MASTERmatic Lux M25L</p> <p><b>Ref.: 44-447</b> (Ref. KaVo: 1.009.3634 + 0.201.8157 + 1.009.3638)</p>	<p><b>24<sup>80</sup>€</b></p>

## Tapas compatibles contra ángulos Bien Air®

RUMAR

## Modelos para Bien Air®

## Relacionados

	<p>1:1 1:1 L</p> <p><b>Ref.: 44-0550</b> (Ref. Bien Air: 1500550)</p>	<p><b>56<sup>80</sup>€</b></p>
---	---	--------------------------------

**Modelos para Bien Air®**

**Relacionados**

	<p>1:5 1:5L</p> <p><b>Ref.: 44-445</b> (Ref. Bien Air: 1500169)</p> <p><b>24'80€</b></p>	
	<p>20:1 20:1L</p> <p><b>Ref.: 44-430</b> (Ref. Bien Air: 15010027)</p> <p><b>29'80€</b></p>	







▶ **Tapas compatibles contra ángulos Sirona®**



**Modelos para Sirona®**

**Relacionados**



PRECIO MÁS BAJO

	<p>T1 Classic S200L (SN≤32 001) T1 Line C200L (SN&gt;43 000 &amp; &gt;65 000) T1 Line C200 (SN&gt;30 000)</p> <p>T3 Line E200L T2 Line A200L (SN&lt;7804 &amp; &gt;7805) T2 Line A170L</p> <p>T3 Line E200 (SN&lt;2325 &amp; &gt;2326) SIROPure P200SL SIROPure P200IL</p> <p><b>Ref.: 44-407</b> (Ref. Sirona: 8925083 + 5996967 + 5947957)</p> <p><b>24'80€</b></p>	<p>Llave Ref.: 49-818</p>
	<p>T2 Line A40L T2 Line A6L T3 Line E40</p> <p>T3 Line E6 SIROPure P40SL (ADA) SIROPure P40IL (ADA)</p> <p>SIROPure P6SL (ADA) SIROPure P6SIL (ADA)</p> <p><b>Ref.: 44-409</b> (Ref. Sirona: 8925083 + 8917924 + 5947957)</p> <p><b>56'80€</b></p>	<p>Llave Ref.: 49-818</p>
	<p>T1 Classic S40L T1 Classic S6L T1 Line C40 (ADA) T1 Line C40L (ADA)</p> <p>T1 Line C6 T1 Line C6L T1 Line C1.6 T1 Line C1.6L</p> <p>Siropure P40SL Siropure P40IL Siropure P6SL Siropure P6IL</p> <p><b>Ref.: 44-408</b> (Ref. Sirona : 8925083 + 6259639 + 5947957)</p> <p><b>24'80€</b></p>	<p>Llave Ref.: 49-818</p>
	<p>T1 Classic S200L (SN≥32 002) T1 Classic S200L T1 Classic S200L mini T1 Line C200L (SN&gt;68 381 &amp; &lt;43 000)</p> <p>T1 Line C200L (SN&lt;302 000 &amp; &gt;302 000) T1 Line C200L mini T2 Line A200 (SN&lt;302 000 &amp; &gt;302 000)</p> <p>T2 S-Line AS200L T3 S-LINE ES200 SIROPure P200SL SIROPure P200IL T3 LINE E200</p> <p><b>Ref.: 44-410</b> (Ref. Sirona : 6049337)</p> <p><b>24'80€</b></p>	<p>Llave Ref.: 49-821</p>
	<p>T1 Classic S40L T1 Classic S6L T1 Classic S1,6L T1 Classic S40L (SN&gt;202 000) T1 Classic S6L (SN&gt;202 000) T1 Classic S1,6L (SN&gt;202 000) T1 Classic C40L (SN&gt;65 000) T1 Classic C6L (SN&gt;65 000) T1 Classic C1,6L (SN&gt;65 000) T1 Classic C40L (SN&gt;202 000) T1 Classic C6L (SN&gt;202 000) T1 Line C40 T1 Line C40 mini</p> <p>T1 Line C40L T1 Line C40L mini T1 Line C6 T1 Line C6L mini T1 Line C1.6 T1 Line C1.6L T2 S-Line AS40L T2 S-Line AS6L T3 S-Line ES40 T3 S-Line ES6 SIROPure P40SL SIROPure P40IL SIROPure P6SL</p> <p>SIROPure P6IL T2 Line A6L (SN&gt;202 000) T2 Line A40L (SN&gt;202 000) T3 Line E40 (SN&gt;202 000) T3 Line E6 (SN&gt;202 000) T1 Line C1,6L (SN &gt;202 000)</p> <p><b>Ref.: 44-411</b> (Ref. Sirona: 6049329)</p> <p><b>24'80€</b></p>	<p>Llave Ref.: 49-821</p>
	<p>Dentsply X-Smart Plus 6:1</p> <p><b>Ref.: 44-433</b></p> <p><b>29'80€</b></p>	<p>Llave Ref.: 49-835</p>



## Modelos para Sirona®

## Relacionados







	Dentsply X-Smart 16:1  <b>Ref.: 44-436</b>	<b>24<sup>80</sup>€</b>	Llave Ref.: 49-818
	TI Line ENDO 6L  <b>Ref.: 44-471</b> (Ref. Sirona: 65444444)	<b>19<sup>80</sup>€</b>	Llave Ref.: 49-821

## Tapas compatibles contra ángulos W&amp;H®

RUMAR

## Modelos para W&amp;H®

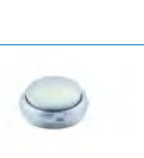





## Relacionados

	WS-75 WS-75E WS-75KM WS-75E (N/S>30000)	WS-75KM (N/S>30000) WI-75E (N/S>01001) WI-75KM (N/S>01001) WI-75 LED G (N/S>01001)	WS-75 LED G (N/S DE 01001 a 25335)  (modelos fabricados hasta 2008)	<b>Ref.: 44-376</b> (Ref. W&H: 04940500)	<b>29<sup>80</sup>€</b>	
	Synea WA-56 (desde 2007) Synea WA-56LT (desde 2007)			<b>Ref.: 44-377</b> (Ref. W&H: 03819600)	<b>29<sup>80</sup>€</b>	
	Alegra WE-56 (hasta 2008) Alegra WE-56A (hasta 2008) Alegra WE-56E (hasta 2008)	Alegra WE-56LED (hasta 2008)		<b>Ref.: 44-379</b> (Ref. W&H: 05843800)	<b>29<sup>80</sup>€</b>	
	Trend WD-56			<b>Ref.: 44-412</b>	<b>29<sup>80</sup>€</b>	
	Synea WA-99A (desde 2007) Synea WA-99LT (desde 2007)			<b>Ref.: 44-413</b> (Ref. W&H: 07771800 + 07771700 + 04952800)	<b>56<sup>80</sup>€</b>	Llave Ref.: 49-820
	Alegra WE-56 (desde 2008) Alegra WE-56T (desde 2008)			<b>Ref.: 44-472</b> (Ref. W&H: 06993800)	<b>80<sup>00</sup>€</b>	Llave Ref.: 44-763
	Synea WA-56LT (hasta 2007)			<b>Ref.: 44-473</b> (Ref. W&H: 05345200)	<b>80<sup>00</sup>€</b>	

Modelos para W&H®		Relacionados
	<p>Alegra WE-99A Alegra WE-99 LED G Fusion WG-99LT (N/S &lt;007801)</p> <p>Fusion WG-99 LED G (N/S &lt;007801)</p>	
	<b>Ref.: 44-474</b> (Ref. W&H: 05846000)	<b>80'00€</b> <span style="float: right;"><b>BAJO PEDIDO</b></span>
	<p>Synea WA-99A Synea WA-99A LED (Hasta 2007)</p>	
	<b>Ref.: 44-475</b> (Ref. W&H: 04943000)	<b>80'00€</b>
	<p>Fusion WG-99LT (N/S&gt;007802) Visio WK-99LT (N/S&gt;01001) Fusion WG-99A (N/S&gt;001819)</p>	
	<b>Ref.: 44-476</b>	<b>91'80€</b> <span style="float: right;"><b>BAJO PEDIDO</b></span>

▶ Tapas compatibles contra ángulos **NSK®**

RUMAR



Modelos para NSK®		Relacionados
	<p>Ti-Max TI25 Ti-Max TI25L Ti-Max X25 Ti-Max X25L</p> <p>S-Max M25 S-Max M25L FPB-Y</p>	<p>Llave Ref.: 30-610 Llave Ref.: 30-613</p>
	<b>Ref.: 44-387</b> (Ref. NSK: C601 050)	<b>19'80€</b>
	<p>S-Max M95 S-Max M95L Ti-Max X95 Ti-Max X95L</p>	<p>Llave Ref.: 44-762 Llave Doble Ref.: 30-615</p>
	<b>Ref.: 44-404</b>	<b>22'80€</b>
	<p>MP-Y MP-F MPA-Y</p> <p>MPAS-Y</p>	<p>Llave Ref.: 30-611</p>
	<b>Ref.: 44-403</b>	<b>28'00€</b>
	<p>Arandela metálica cabeza: S-Max SG20 S-Max SG20L Ti-Max X-SG20L</p> <p>Ti-Max X-DSG20L</p>	
	<b>Ref.: 44-400MD</b> (Ref. NSK: 20000341)	<b>3'00€</b>
	<p>Arandela goma azul: S-Max SG20 S-Max SG20L Ti-Max X-SG20L</p> <p>Ti-Max X-DSG20L</p>	
	<b>Ref.: 44-400RD</b> (Ref. NSK: C495360A)	<b>3'00€</b>
	<p>S-Max SG20 S-Max SG20L Ti-Max X-SG20L</p> <p>Ti-Max X-DSG20L</p>	<p>Llave Ref.: 30-616</p>
	<b>Ref.: 44-391</b> (Ref. NSK: 10000228)	<b>21'80€</b>

PRECIO MÁS BAJO

Modelos para NSK®		Relacionados
	FX15 FX25 FX23  <b>Ref.:</b> 44-456 (Ref. NSK: C1052500)	Llave Ref.: 49-839  19'80€
	Ti-Max Z25 Ti-Max Z25L  <b>Ref.:</b> 44-459	19'80€
	Ti-Max Z95 (Modelo antiguo) Ti-Max Z95L (Modelo antiguo)  <b>Ref.:</b> 44-464	Llave Ref.: 30-615  19'80€
	Ti-Max Z95 (Modelo NUEVO) Ti-Max Z95L (Modelo NUEVO)  <b>Ref.:</b> 44-467	22'80€



### Tapas compatibles contra ángulos Castellini®

RUMAR

Modelos para Castellini®		Relacionados
	Goldspeed S1 Goldspeed SIL (Excepto Goldspeed EVO S1 y Goldspeed EVO S1-L)  <b>Ref.:</b> 44-485	42'80€
 <small>Imagen no disponible</small>	Goldspeed EVO S1  <b>Ref.:</b> 44-484	Llave Ref.: 49-834  68'00€

### Tapas contra ángulos MK-dent®



Modelos para MK-dent®		Relacionados
	LCH11 LCH21 LS9011  LS9021  <b>Ref.:</b> 05-BC9001	Llave Ref.: 05-KE2011T  44'80€
	LCH16  <b>Ref.:</b> 05-BC9016	Llave Ref.: 05-KE1023T  44'80€

HASTA AGOTAR

Tapas contra ángulos **Woodpecker®**











## Modelos para WOODPECKER®















	<p>20:1 WP-1L (IMPLANTER LED / DTE IMPLANT X LED)</p> <p><b>Ref.: 28-28039</b></p>	<p><b>Relacionados</b></p> <p><b>Rotor Ref.:</b> 28-28037 <b>Eje Ref.:</b> 28-28038 <b>Llave Ref.:</b> 28-28048</p> <p><b>29<sup>80</sup>€</b></p>
---	--	--



## RESTO REPUESTOS CONTRA ÁNGULOS

Resto repuestos contra ángulos **KaVo®**

RUMAR



	Descripción	Observaciones
	<p>Conjunto repuestos cabeza 68LDN. (Rotor completo + carcasa + botón + eje + tornillo + muelle).</p> <p><b>Ref.: 44-740</b></p>	<p><b>170<sup>00</sup>€</b></p>
	<p>Carcasa 68LH.</p> <p><b>Ref.: 05-SP2001</b> (Ref. KaVo: 0.540.3631)</p>	<p><b>51<sup>40</sup>€</b></p>
	<p>Carcasa 67LH.</p> <p><b>Ref.: 05-SP2101</b> (Ref. KaVo: 0.540.3641)</p>	<p><b>51<sup>40</sup>€</b></p>
	<p>Carcasa 80LD.</p> <p><b>Ref.: 05-SP2221</b> (Ref. KaVo: 0.540.2381)</p>	<p><b>58<sup>80</sup>€</b></p> <p>HASTA AGOTAR</p>
	<p>Carcasa completa 68LDN, 68GDN.</p> <p><b>Ref.: 44-712</b> (Ref. KaVo: 0.540.2231)</p>	<p><b>58<sup>80</sup>€</b></p>
	<p>Segmento 68LH, L68, 67LH, L67, 68LDN y 67LDN.</p> <p><b>Ref.: 44-702</b> (Ref. KaVo: 0.540.4102)</p>	<p><b>5<sup>90</sup>€</b></p>
	<p>Chaveta 68LH, L68, 67LH, L67, 68LDN y 67LDN.</p> <p><b>Ref.: 44-703</b> (Ref. KaVo: 0.540.4522)</p>	<p><b>12<sup>80</sup>€</b></p>
	<p>Anillo de conducción 68LH, L68, 67LH, L67, 68LDN y 67LDN.</p> <p><b>Ref.: 05-SP2007</b> (Ref. KaVo: 0.540.4072)</p>	<p>Útil Ref.: 44-752</p> <p><b>1<sup>10</sup>€</b></p>
	<p>Muelle de presión 68LH, L68, 67LH, L67, 68LDN y 67LDN.</p> <p><b>Ref.: 05-SP2009</b> (Ref. KaVo: 0.201.8958)</p>	<p><b>1<sup>20</sup>€</b></p> <p>HASTA AGOTAR</p>
	<p>Muelle 68LH, L68, 67LH, L67, 68LDN y 67LDN.</p> <p><b>Ref.: 05-SP2023</b> (Ref. KaVo: 0.540.3162)</p>	<p><b>2<sup>60</sup>€</b></p>
	<p>Muelle para 20LH, 2068CHC, 2068LHC, 20CH, E20, E20L y compatibles.</p> <p><b>Ref.: 05-SP1004</b> (Ref. KaVo: 0.201.7442)</p>	<p><b>1<sup>30</sup>€</b></p> <p>HASTA AGOTAR</p>

	Descripción	Observaciones
	Muelle para 20LH, 2068CHC, 2068LHC, 20CH, E20 y E20L. <b>Ref.: 05-SP1014</b> (Ref. KaVo: 0.201.8022)	0'90€
	Muelle de presión 20LH, 2068LH y E20L. <b>Ref.: 05-SP1022</b> (Ref. KaVo: 0.201.8182)	1'00€ <b>HASTA AGOTAR</b>
	Tornillo 68LH, L68, 67LH, L67, 68LDN y 67LDN. <b>Ref.: 05-SP2021</b> (Ref. KaVo: 0.201.0005)	Destornillador: 05-RT2016 1'90€
	Tubos de medios para 20LH, 2068CHC, 2068LHC, 20CH, E20 y E20L. <b>Ref.: 05-SP1001</b> (Ref. KaVo: 0.534.1581)	76'70€ <b>HASTA AGOTAR</b>
	Anillo de cierre para 20LH, 2068CHC, 2068LHC, 20CH, 20CH, E20 y E20L. <b>Ref.: 05-SP1003</b> (Ref. KaVo: 0.534.4012)	26'40€ <b>HASTA AGOTAR</b>
	Anillo de alambre para 20LH, 2068CHC, 2068LHC, 20CH, E20, E20L y compatibles. <b>Ref.: 05-SP1005</b> (Ref. KaVo: 0.534.3532)	1'00€
	Anillo de cierre roscado para 20LH, 2068CHC, 2068LHC, 20CH, E20 y E20L. <b>Ref.: 05-SP1021</b> (Ref. KaVo: 0.524.4062)	Llave Ref.: 05-KE2011BT 11'80€ <b>HASTA AGOTAR</b>
	Bola para 20LH, 2068CHC, 2068LHC, 20CH, E20 y E20. <b>Ref.: 05-SP1006</b> (Ref. KaVo: 0.257.4118)	3,0 mm 0'80€
	Bola para 20LH, 2068CHC, 2068LHC, 20CH, E20 y E20L. <b>Ref.: 05-SP1007</b> (Ref. KaVo: 0.257.4105)	1,5 mm 0'80€ <b>HASTA AGOTAR</b>
	Distanciador para 20LH, 2068CHC, 2068LH, 20CH, E20 y E20L. <b>Ref.: 05-SP1012</b> (Ref. KaVo: 0.553.1602)	4'70€ <b>HASTA AGOTAR</b>
	Casquillo para 20LH, 2068CHC, 2068LHC, 20CH, E20 y E20L. <b>Ref.: 05-SP1015</b> (Ref. KaVo: 0.524.3192)	5'20€
	Tope arrastre trasero para 20LH, 2068CHC, 2068LHC, 20CH, E20 y E20L. <b>Ref.: 05-SP1016</b> (Ref. KaVo: 0.524.3182)	28'30€
	Pasador para tope de arrastre para 20LH, 2068LHC, 20CH, E20 y E20L. <b>Ref.: 05-SP1017</b> (Ref. KaVo: 0.202.0504)	1'10€
	Inserto 20CH, 2068CHC y E20. <b>Ref.: 05-SP1019</b> (Ref. KaVo: 0.534.4042)	65'90€ <b>HASTA AGOTAR</b>

	Descripción	Observaciones
	Inserto 20LH, 2068LH y E20L. <b>Ref.: 05-SP1019L</b> (Ref. KaVo: 0.534.4082)	65 <sup>90</sup> € <span style="float: right; background-color: yellow;">HASTA AGOTAR</span>
	Guía posicionamiento 20LH, 2068LH y E20L. <b>Ref.: 05-SP1023</b> (Ref. KaVo: 0.534.2442)	19 <sup>60</sup> €
	Barra transmisión luz 20LH, 2068LH y E20L. <b>Ref.: 05-SP9001</b> (Ref. KaVo: 0.534.2762)	76 <sup>70</sup> € <span style="float: right; background-color: yellow;">HASTA AGOTAR</span>

▶ Resto repuestos contra ángulos **W&H®**

RUMAR

	Descripción	Observaciones
	Chaveta para W&H. <b>Ref.: 44-372</b> (Ref. W&H 03819300)	12 <sup>80</sup> €
	Anillo conducción para W&H. <b>Ref.: 44-373</b> (Ref. W&H 03819200)	1 <sup>40</sup> €

▶ Resto repuestos contra ángulos **Woodpecker®**



NUEVO

















Imagen no disponible











	Descripción	Observaciones
	Carcasa cabeza 20:1 WP-1L con tornillo <b>Ref.: 28-28050</b>	128 <sup>00</sup> €

▶ Resto repuestos contra ángulos **MK-dent®**

RUMAR

	Descripción	Observaciones
	Carcasa LCH11 y LS9011. <b>Ref.: 05-SP2001</b>	51 <sup>40</sup> €
	Carcasa LCH21 y LS9021. <b>Ref.: 05-SP2101</b>	51 <sup>40</sup> €
	Carcasa LS9016. <b>Ref.: 05-SP2221</b>	58 <sup>80</sup> € <span style="float: right; background-color: yellow;">HASTA AGOTAR</span>
	Segmento LCH11, LCH21, LPH11, LPH21, LS9011 y LS9021. <b>Ref.: 05-SP2004</b>	9 <sup>80</sup> €
	Chaveta LCH11, LCH21, LPH11, LPH21, LS9011 y LS9021. <b>Ref.: 05-SP2006</b>	20 <sup>80</sup> €



	Descripción	Observaciones
	Anillo de conducción LCH11, LCH21, LPH11, LPH21, LS9011 y LS9021. <b>Ref.: 05-SP2007</b>	Útil Ref.: 44-752 1'80€
	Muelle de presión LCH11, LPH11, LPH21, LS9011, y LS9021. <b>Ref.: 05-SP2009</b>	1'20€ HASTA AGOTAR
	Muelle LCH11, LCH21, LPH11, LPH21, LS9011 y LS9021. <b>Ref.: 05-SP2023</b>	2'60€
	Muelle para LS2011 y LS2011L. <b>Ref.: 05-SP1004</b>	1'30€ HASTA AGOTAR
	Muelle de presión para LS2011 y LS2011L. <b>Ref.: 05-SP1014</b>	0'90€
	Muelle de presión LS2011L. <b>Ref.: 05-SP1022</b>	1'00€ HASTA AGOTAR
	Tornillo LCH11, LCH21, LPH11, LPH21, LS9011 y LS9021. <b>Ref.: 05-SP2021</b>	Destornillador: 05-RT2016 1'90€
	Tapa frontal LCH16, LS9016. <b>Ref.: 05-SP2230</b>	4'70€
	Anillo azul para: LE11, LE11L, LC11, LC11L y LP11L. <b>Ref.: 05-SP0031</b>	1'05€
	Tubos de medios para LS2011L, LE11L, LC11L y LP11L. <b>Ref.: 05-SP1001</b>	76'70€ HASTA AGOTAR
	Anillo de cierre para LS2011 y LS2011L. <b>Ref.: 05-SP1003</b>	26'40€ HASTA AGOTAR
	Anillo de alambre para LS2011 y LS2011L. <b>Ref.: 05-SP1005</b>	1'00€
	Anillo de cierre roscado para LS2011 y LS2011L. <b>Ref.: 05-SP1021</b>	Destornillador: 05-RT2016 Llave Ref.: 05-KE2011BT 11'80€ HASTA AGOTAR
	Bola para LS2011 y LS2011L. <b>Ref.: 05-SP1006</b>	3,0 mm 0'80€

	Descripción	Observaciones
	Bola para LS2011 y LS2011L. <b>Ref.: 05-SP1007</b>	1,5 mm 0'80€ <b>HASTA AGOTAR</b>
	Distanciador para LS2011 y LS2011L. <b>Ref.: 05-SP1012</b>	4'70€ <b>HASTA AGOTAR</b>
	Casquillo para LS2011 y LS2011L. <b>Ref.: 05-SP1015</b>	5'20€
	Tope arrastre trasero para LS2011 y LS2011L. <b>Ref.: 05-SP1016</b>	28'30€
	Pasador para tope de arrastre para LS2011 y LS2011L. <b>Ref.: 05-SP1017</b>	1'10€
	Inserto LS2011. <b>Ref.: 05-SP1019</b>	65'90€ <b>HASTA AGOTAR</b>
	Inserto LS2011L. <b>Ref.: 05-SP1019L</b>	65'90€ <b>HASTA AGOTAR</b>
	Guía posicionamiento LS2011L. <b>Ref.: 05-SP1023</b>	19'60€
	Barra transmisión luz LS2011L. <b>Ref.: 05-SP9001</b>	76'70€ <b>HASTA AGOTAR</b>
	Barra transmisión luz LE11L, LC11L y LP11L. <b>Ref.: 05-SP9002</b>	76'80€











## REPUESTOS PIEZAS DE MANO

Repuestos piezas de mano **KaVo® / MK-dent®**

RUMAR

	Descripción	Observaciones
	Anillo azul para: <b>MK-dent:</b> LE01, LE01L, LC01, LC01L y LP01L. <b>Ref.: 05-SP0031</b>	1'05€
	Anillo de presión para: <b>MK-dent:</b> LS1011 <b>KaVo:</b> 10LH <b>Ref.: 05-SP1036</b> (Ref. KaVo: 0.524.2722)	7'80€ <b>HASTA AGOTAR</b>



















	Descripción	Observaciones
	Eje completo para: <b>MK-dent:</b> LE01, LE01L, LC01, LC01L y LP01L. <b>Ref.: 05-SP1138</b>	228 <sup>00</sup> € <span>HASTA AGOTAR</span>
	Anillo de cierre para: <b>MK-dent:</b> LS1011 <b>KaVo:</b> 10LH <b>Ref.: 05-SP1039</b> (Ref. KaVo: 0.524.1561)	50 <sup>80</sup> €
	Cartucho para rodamiento de: <b>MK-dent:</b> LS1011 <b>KaVo:</b> 10LH <b>Ref.: 05-SP1040</b> (Ref. KaVo: 0.524.3252)	48 <sup>20</sup> € <span>HASTA AGOTAR</span>
	Anillo para: <b>MK-dent:</b> LS1011 <b>KaVo:</b> 10LH <b>Ref.: 05-SP1041</b> (Ref. KaVo: 0.524.2742)	8 <sup>00</sup> € <span>HASTA AGOTAR</span>
	Perno para: <b>MK-dent:</b> LS1011 <b>KaVo:</b> 10LH <b>Ref.: 05-SP1042</b> (Ref. KaVo: 0.524.3262)	5 <sup>50</sup> € <span>HASTA AGOTAR</span>
	Anillo roscado para: <b>MK-dent:</b> LS1011 <b>KaVo:</b> 10LH <b>Ref.: 05-SP1043</b> (Ref. KaVo: 0.524.2772)	6 <sup>90</sup> € <span>HASTA AGOTAR</span>
	Arandela para: <b>MK-dent:</b> LS1011 <b>KaVo:</b> 10LH <b>Ref.: 05-SP1044</b> (Ref. KaVo: 0.524.2762)	4 <sup>40</sup> € <span>HASTA AGOTAR</span>
	Tornillo para: <b>MK-dent:</b> LS1011 <b>KaVo:</b> 10LH <b>Ref.: 05-SP1045</b> (Ref. KaVo: 0.201.0401)	1 <sup>40</sup> €
	Inserto para: <b>MK-dent:</b> LS1011 <b>KaVo:</b> 10LH <b>Ref.: 05-SP1046</b> (Ref. KaVo: 0.524.4012)	64 <sup>20</sup> € <span>HASTA AGOTAR</span>
	Clip para: <b>MK-dent:</b> LS1011 <b>KaVo:</b> 10LH <b>Ref.: 05-SP1047</b> (Ref. KaVo: 0.524.3642)	1 <sup>90</sup> € <span>HASTA AGOTAR</span>







## REPUESTOS MICROMOTORES NEUMÁTICOS

### Repuestos micromotores MK-dent®

RUMAR

	Descripción	Observaciones
	Anillo de regulación de agua AM1014, AM1016 y AM1116. <b>Ref.: 05-SP1051</b>	27 <sup>80</sup> € <span>HASTA AGOTAR</span>
	Anillo de regulación de aire AM1014, AM1016 y AM1116. <b>Ref.: 05-SP1052</b>	32 <sup>80</sup> € <span>HASTA AGOTAR</span>

	Descripción	Observaciones
 Imagen no disponible	Muelle de presión AM1014, AM1016 y AM1116.  <b>Ref.: 05-SP1054</b>	Igual a SP0482  <b>1'00.€</b> <span style="float: right;">HASTA AGOTAR</span>
 Imagen no disponible	Tapa tubo 05-SP1059 del AM1014.  <b>Ref.: 05-SP1056</b>	<b>6'90.€</b> <span style="float: right;">HASTA AGOTAR</span>
 Imagen no disponible	Bola regulador agua AM1014, AM1016 y AM1116.  <b>Ref.: 05-SP0485</b>	<b>2mm</b> Igual a 05-SP1058  <b>1'00.€</b>
 Imagen no disponible	Tubito de irrigación AM1014, AM1016 y AM1116.  <b>Ref.: 05-SP1059</b>	<b>7'50.€</b> <span style="float: right;">HASTA AGOTAR</span>
 Imagen no disponible	Tapa roscada AM1014, AM1016 y AM1116.  <b>Ref.: 05-SP1060</b>	Llave Ref.: 05-KE2014  <b>14'30.€</b> <span style="float: right;">HASTA AGOTAR</span>
 Imagen no disponible	Disco AM1014, AM1016 y AM1116.  <b>Ref.: 05-SP1061</b>	<b>1'10.€</b> <span style="float: right;">HASTA AGOTAR</span>
 Imagen no disponible	Arandela AM1014, AM1016 y AM1116.  <b>Ref.: 05-SP1062</b>	<b>1'80.€</b> <span style="float: right;">HASTA AGOTAR</span>
 Imagen no disponible	Bloque regulación AM1014.  <b>Ref.: 05-SP1063</b>	<b>32'80.€</b> <span style="float: right;">HASTA AGOTAR</span>
 Imagen no disponible	Muelle de presión regulador AM1014, AM1016 y AM1116.  <b>Ref.: 05-SP1064</b>	<b>2'30.€</b> <span style="float: right;">HASTA AGOTAR</span>
 Imagen no disponible	Regulador AM1014, AM1016 y AM1116.  <b>Ref.: 05-SP1065</b>	<b>3'00.€</b> <span style="float: right;">HASTA AGOTAR</span>
 Imagen no disponible	Perno plano AM1014, AM1016 y AM1116.  <b>Ref.: 05-SP1068</b>	<b>3'90.€</b> <span style="float: right;">HASTA AGOTAR</span>
 Imagen no disponible	Cilindro exterior rotor AM1014, AM1016 y AM1116.  <b>Ref.: 05-SP1069</b>	<b>42'90.€</b> <span style="float: right;">HASTA AGOTAR</span>
 Imagen no disponible	Funda protección AM1014, AM1016 y AM1116.  <b>Ref.: 05-SP1074</b>	<b>59'60.€</b> <span style="float: right;">HASTA AGOTAR</span>
 Imagen no disponible	Tornillo AM1014, AM1016 y AM1116.  <b>Ref.: 05-SP1075</b>	<b>5'80.€</b> <span style="float: right;">HASTA AGOTAR</span>

	Descripción	Observaciones
 Imagen no disponible	Tornillo AM1014, AM1016 y AM1116. <b>Ref.: 05-SP1078</b>	1'30€
 Imagen no disponible	Muelle de presión AM1014, AM1016 y AM1116. <b>Ref.: 05-SP1079</b>	0'95€ <b>HASTA AGOTAR</b>
 Imagen no disponible	Pasador AM1014, AM1016 y AM1116. <b>Ref.: 05-SP1080</b>	0'95€
 Imagen no disponible	Cable goma AM1014. <b>Ref.: 05-SP1082</b>	0'50€ <b>HASTA AGOTAR</b>
 Imagen no disponible	Cable goma AM1014. <b>Ref.: 05-SP1083</b>	0'60€ <b>HASTA AGOTAR</b>
	Tapa delantera con conector INTRA AM1014. <b>Ref.: 05-SP1088</b>	63'80€ <b>HASTA AGOTAR</b>
	Regulador de aire, completo AM1014. <b>Ref.: 05-SP1089</b>	158'00€ <b>HASTA AGOTAR</b>



Repuestos micromotores **KaVo**<sup>®</sup>

RUMAR

	Descripción	Observaciones
	Pasador tope de arrastre todos los modelos micromotores KaVo. <b>Ref.: 20-432</b> (Ref. KaVo: 0.202.0018)	Medidas: 1x4,5mm Puntero: 48-29523 2'30€

## Anillos tóricos micromotores

RUMAR

	Descripción	Observaciones
	Anillo tórico sistema INTRA todos los modelos. <b>Ref.: 30-148</b>	1'00€
 Imagen no disponible	Anillo tórico MK-dent AM1014, AM1016, AM1116 y KaVo 181. <b>Ref.: 05-OR1013</b>	1'40€ <b>HASTA AGOTAR</b>
 Imagen no disponible	Anillo tórico MK-dent AM1014, AM1016, AM1116 y KaVo 181. <b>Ref.: 05-OR1014</b>	1'40€ <b>HASTA AGOTAR</b>
	Anillo tórico MK-dent AM1014, AM1016, AM1116 y KaVo 181. <b>Ref.: 05-OR1016</b>	1'40€ <b>HASTA AGOTAR</b>

▶ Anillos Tóricos Contra Ángulos y Piezas de Mano

	Descripción	Observaciones
0	<p>Anillo tórico contra-ángulos KaVo 20CN, 20LN, 20CH, 20LH, 10CH, 10LH, E20C y E20CL MK-dent LS201/ 2011L/ LS1011.</p> <p><b>Ref.: 05-SP1020</b> (Ref. KaVo: 0.200.6099)</p>	<p>1<sup>50</sup>€</p>

# RODAMIENTOS PARA MICROMOTORES ELÉCTRICOS

Todos los rodamientos que ofrecemos están fabricados por los principales fabricantes de rodamientos a nivel mundial: **myonic**, **Barden**, **GRW**, **NMB**, **NHBB** o **ESI**. Todos fabricados de acuerdo a las normas de precisión ISO\* (normas para roda-





mientos de dimensiones métricas) y ABEC\*\* (rodamientos generalmente en dimensiones de pulgadas).



\* ISO: International Standard Organization.  
\*\* ABEC: Annular Bearing Engineers Conference.

## Rodamientos micromotor KaVo® K190, K191, K192, K196 y K197



RUMAR

Modelos para KaVo®		Descripción
 	Delantero  <b>Ref.: 30-0089</b> (Ref. KaVo: 0.220.0089)	<b>Medidas:</b> 4x11x4mm Liso Bola acero Abierto - Cerrado  <b>9'20€</b>
 	Trasero  <b>Ref.: 30-0136</b> (Ref. KaVo: 0.220.0136)	<b>Medidas:</b> 2x6x2,3mm Liso Bola acero Abierto - Cerrado  <b>9'80€</b>

**Kit 2 rodamientos: 30-0089 + 30-0136**

## Rodamientos micromotor KaVo® KL700

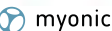

RUMAR

Modelos para KaVo®		Descripción
 	Delantero  <b>Ref.: 45-200</b> (Ref. KaVo: 0.220.0219)	<b>Medidas:</b> 5x11x5mm Liso Bola acero Cerrado - Cerrado  <b>12'80€</b>
 	Trasero  <b>Ref.: 30-0218</b> (Ref. KaVo: 0.220.0218)	<b>Medidas:</b> 3x8x3mm Liso Bola acero Cerrado - Cerrado  <b>11'80€</b>

**Kit 2 rodamientos: 45-200 + 30-0218**

## Rodamientos micromotor KaVo® KL701

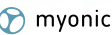
RUMAR

Modelos para KaVo®		Descripción
 	Delantero  <b>Ref.: 30-7185</b> (Ref. KaVo: 1.000.7185)	<b>Medidas:</b> 5x8x3mm Liso Bola acero Cerrado - Cerrado  <b>16'80€</b>
 	Trasero  <b>Ref.: 30-0218</b> (Ref. KaVo: 0.220.0218)	<b>Medidas:</b> 3x8x3mm Liso Bola acero Cerrado - Cerrado  <b>11'80€</b>

**Kit 2 rodamientos: 30-7185 + 30-0218**

## Rodamientos micromotor KaVo® K200

RUMAR

## Modelos para KaVo®





	Modelos para KaVo®	Descripción
 myonic	Delantero  <b>Ref.: 30-7185</b> (Ref. KaVo: 1.000.7185)	<b>Medidas:</b> 5x8x3mm Liso Bola acero Cerrado - Cerrado
 GRW	Trasero  <b>Ref.: 30-0136</b> (Ref. KaVo: 0.220.0136)	<b>Medidas:</b> 2x6x2,3mm Liso Bola acero Abierto - Cerrado

Kit 2 rodamientos: 30-7185 + 30-0136









## Rodamientos micromotor KaVo® K9 antiguo (K9 EWL 950 / 955)

RUMAR

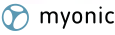

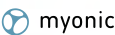

## Modelos para KaVo®



	Modelos para KaVo®	Descripción
 myonic	Delantero inducido  <b>Ref.: 30-2157</b> (Ref. KaVo: 0.220.0157)	<b>Medidas:</b> 4x11x4mm Liso Bola acero Cerrado - Cerrado
 myonic	Trasero inducido  <b>Ref.: 30-2158</b> (Ref. KaVo: 0.220.0158)	<b>Medidas:</b> 2x6x2,3mm Liso Bola acero Cerrado - Cerrado
 myonic	Eje K9 EWL 950 Trasero Eje K9 EWL 955  <b>Ref.: 30-2113</b> (Ref. KaVo: 0.220.0113)	<b>Medidas:</b> 8x16x6mm Liso Bola acero Cerrado - Cerrado
 NMB	Delantero eje K9 EWL 955  <b>Ref.: 30-2148</b> (Ref. KaVo: 0.220.0148)	<b>Medidas:</b> 8x16x4mm <b>Velocidad:</b> 20.000 rpm Liso Bola acero Cerrado - Cerrado
 myonic	Kit 2 rodamientos inducido: 30-2157 + 30-2158  <b>Ref.: 30-2011</b>	

Rodamientos micromotor **KaVo® K9 (azul) (K9 EWL 4930 / 4932 / 4933)**

Modelos para KaVo®		Descripción
 	Delantero inducido  <b>Ref.: 30-2223</b> (Ref. KaVo: 0.220.0223)	<b>Medidas:</b> 5x11x4mm Liso Bola acero Cerrado - Cerrado  <b>13'80€</b>
 	Trasero inducido  <b>Ref.: 30-2158</b> (Ref. KaVo: 0.220.0158)	<b>Medidas:</b> 2x6x2,3mm Liso Bola acero Cerrado - Cerrado  <b>15'80€</b>
 	Delantero eje  <b>Ref.: 30-2055</b> (Ref. KaVo: 0.220.0055)	<b>Medidas:</b> 7x14x1x7,5mm Liso Bola acero Cerrado - Cerrado  <b>45'80€</b>
 	Trasero eje  <b>Ref.: 30-2044</b> (Ref. KaVo: 0.220.0044)	<b>Medidas:</b> 7,85x15,89x5,98mm Liso Bola acero Cerrado - Cerrado  <b>26'80€</b>
	Kit 2 rodamientos inducido: 30-2223 + 30-2158  <b>Ref.: 30-2111</b>	<b>24'80€</b>
	Kit 2 rodamientos eje: 30-2055 + 30-2044  <b>Ref.: 30-2112</b>	<b>65'80€</b>

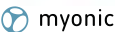







Rodamientos micromotor **KaVo® K10**

Modelos para KaVo®		Descripción
 	Delantero inducido  <b>Ref.: 30-2779</b> (Ref. KaVo: 0.220.0779)	<b>Medidas:</b> 4x11x4mm Liso Bola acero Cerrado - Cerrado  <b>15'80€</b>
 	Trasero inducido  <b>Ref.: 30-2778</b> (Ref. KaVo: 0.220.0778)	<b>Medidas:</b> 3x8x4mm Liso Bola acero Cerrado - Cerrado  <b>18'80€</b>
 	Eje K10  <b>Ref.: 30-2113</b> (Ref. KaVo: 0.220.0113)	<b>Medidas:</b> 8x16x6mm Liso Bola acero Cerrado - Cerrado  <b>11'80€</b>

	Modelos para KaVo®	Descripción
	Kit 2 rodamientos inducido: 30-2778 + 30-2779  <b>Ref.: 30-2021</b>	<b>32'50€</b>
	Kit 2 rodamientos eje: 2X 30-2113  <b>Ref.: 30-2000</b>	<b>19'30€</b>

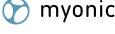
Rodamientos micromotor **KaVo® K11**

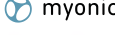
RUMAR







	Modelos para KaVo®	Descripción
 	Trasero inducido  <b>Ref.: 30-2778</b> (Ref. KaVo: 0.220.0778)	<b>Medidas:</b> 3x8x4mm Liso Bola acero Cerrado - Cerrado  <b>18'80€</b>
 	Delantero inducido  <b>Ref.: 30-2779</b> (Ref. KaVo: 0.220.0779)	<b>Medidas:</b> 4x11x4mm Liso Bola acero Cerrado - Cerrado  <b>15'80€</b>
 	Delantero eje  <b>Ref.: 30-2045</b> (Ref. KaVo: 0.220.0045)	<b>Medidas:</b> 7,85x15,89x7,5mm Liso Bola acero Phenolic Abierto - Cerrado  <b>69'80€</b>
 	Trasero eje  <b>Ref.: 30-2044</b> (Ref. KaVo: 0.220.0044)	<b>Medidas:</b> 7,85x15,89x5,98mm Liso Bola acero Cerrado - Cerrado  <b>26'80€</b>
	Kit 2 rodamientos inducido: 30-2778 + 30-2779  <b>Ref.: 30-2021</b>	<b>32'50€</b>
	Kit 2 rodamientos eje: 30-2045 + 30-2044  <b>Ref.: 30-2031</b>	<b>92'30€</b>

Kit Ref. KaVo 0.674.2841:



0.200.0827 + 0.220.0045 + 2X0.222.4042 + 0.220.0044 = 45-0827 + 30-2045 + 2X45-4042 + 30-2044





## Rodamientos micromotor KaVo® K12 / Power Grip todos los modelos

Modelos para KaVo®		Descripción
 GRW	Delantero inducido  <b>Ref.: 30-2779</b> (Ref. KaVo: 0.220.0779)	<b>Medidas:</b> 4x11x4mm Liso Bola acero Cerrado - Cerrado  <b>15'80€</b>
 ISC	Trasero inducido  <b>Ref.: 30-2778</b> (Ref. KaVo: 0.220.0778)	<b>Medidas:</b> 3x8x4mm Liso Bola acero Cerrado - Cerrado  <b>18'80€</b>
 GRW	Delantero eje  <b>Ref.: 30-2055</b> (Ref. KaVo: 0.220.0055)	<b>Medidas:</b> 7x14x1x7,5mm Liso Bola acero Cerrado - Cerrado  <b>45'80€</b>
 myonic	Trasero eje  <b>Ref.: 30-2044</b> (Ref. KaVo: 0.220.0044)	<b>Medidas:</b> 7,85x15,89x5,98mm Liso Bola acero Cerrado - Cerrado  <b>26'80€</b>
	Kit 2 rodamientos inducido: 30-2778 + 30-2779  <b>Ref.: 30-2021</b>	<b>32'50€</b>
	Kit 2 rodamientos eje: 30-2055 + 30-2044  <b>Ref.: 30-2112</b>	<b>65'80€</b>



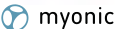

## Rodamientos micromotor KaVo® K4 / K5

Modelos para KaVo®		Descripción
 GRW	Delantero  <b>Ref.: 30-2058</b> (Ref. KaVo: 0.220.0058 + 2x0.200.6199 + 0.200.0692)	<b>Medidas:</b> 7x14x1x7,5mm <b>Incluye:</b> Tóricos y fieltro <b>Especial</b> Liso Bola acero Cerrado - Cerrado <b>Medi</b> 7x14x1x7,5mm  <b>60'80€</b>
 myonic	Trasero  <b>Ref.: 30-2056</b> (Ref. KaVo: 0.220.0056)	<b>Medidas:</b> 10x19x7mm Liso Bola acero Cerrado - Cerrado  <b>21'80€</b>
	Kit 2 rodamientos inducido: 30-2056 + 30-2058  <b>Ref.: 30-205</b>	<b>78'80€</b>

Rodamientos micromotor **KaVo® SF EWL 4004 / 4005**

Modelos para KaVo®		Descripción
 	Rodamiento delantero  <b>Ref.: 30-206</b> (Ref. KaVo: 0.247.6057)	<b>Medidas:</b> 8x22x7mm Liso Bola acero Phenolic Abierto - Cerrado  <b>18´90€</b>
 	Rodamiento trasero  <b>Ref.: 30-207</b> (Ref. KaVo: 0.220.0112)	<b>Medidas:</b> 7x14x5mm Liso Bola acero Abierto - Cerrado  <b>25´80€</b>

Rodamientos micromotor **Bien Air® MC3**

Modelos para Bien Air®		Descripción
 	Delantero  <b>Ref.: 30-130</b> (Ref. Bien Air: 701.01.71)	<b>Medidas:</b> 4x11x4mm Liso Bola acero Cerrado - Cerrado  <b>15´20€</b>
 	Trasero  <b>Ref.: 30-131</b> (Ref. Bien Air: 701.01.70)	<b>Medidas:</b> 2,38x7,938x3,571mm Liso Bola acero Cerrado - Cerrado  <b>16´40€</b>



Rodamientos micromotor **Bien Air® MC2**

Modelos para Bien Air®		Descripción
 	Trasero (Excepto Aquilón)  <b>Ref.: 30-132</b> (Ref. Bien Air: 701.01.23)	<b>Medidas:</b> 2,38x7,938x9,05x3,571mm Con reborde Bola acero Cerrado - Cerrado  <b>15´50€</b>
 	Delantero Aquilón (delantero y trasero)  <b>Ref.: 30-133</b> (Ref. Bien Air: 701.01.14)	<b>Medidas:</b> 3,175x7,938x3,571mm Liso Bola acero Cerrado - Cerrado  <b>16´80€</b>

Rodamientos micromotor **Bien Air® MX**

RUMAR

## Modelos para Bien Air® MX

	Modelos para Bien Air® MX	Descripción
 	Delantero  <b>Ref.: 30-134</b> (Ref. Bien Air: 701.01.93)	<b>Medidas:</b> 4,763x7,938x3,175mm Liso Bola acero Cerrado - Cerrado
 	Trasero  <b>Ref.: 30-135</b> (Ref. Bien Air: 701.01.94)	<b>Medidas:</b> 3,967x7,938x3,175mm Liso Bola acero Cerrado - Cerrado





14'80€

14'80€

Rodamientos micromotor **Sirona®**

RUMAR

## Modelos para Sirona®

	Modelos para Sirona®	Descripción
 	SLI, delantero  <b>Ref.: 45-350</b> (Ref. Sirona: 7040801)	<b>Medidas:</b> 4x9x4mm Con rebaje Bola acero Cerrado - Cerrado
 	SLI, trasero  <b>Ref.: 45-351</b> (Ref. Sirona: 7036130)	<b>Medidas:</b> 2x6x2,3mm Con rebaje Bola acero Cerrado - Cerrado

12'90€

19'50€

Rodamientos micromotor **W&H®**

RUMAR

## Modelos para W&amp;H®

	Modelos para W&H®	Descripción
 	Delantero inducido MF Techtorque Delantero inducido MF Perfecta  <b>Ref.: 45-200</b> (Ref. W&H: 02685500)	<b>Medidas:</b> 5x11x5mm <b>Especial</b> Liso Bola acero Cerrado - Cerrado
 	Trasero inducido MF Techtorque Trasero inducido MF Perfecta  <b>Ref.: 30-2778</b> (Ref. W&H: 01206200)	<b>Medidas:</b> 3x8x4mm Liso Bola acero Cerrado - Cerrado
 	Delantero pieza de mano azul / negra MF Techtorque Delantero pieza de mano azul / negra MF Perfecta  <b>Ref.: 30-2113</b> (Ref. W&H: 03202300)	<b>Medidas:</b> 8x16x6mm Liso Bola acero Cerrado - Cerrado
 	Trasero pieza de mano azul / negra MF Techtorque Trasero pieza de mano azul / negra MF Perfecta  <b>Ref.: 45-203</b> (Ref. W&H: 03202200)	<b>Medidas:</b> 7x14x5mm Liso Bola acero Cerrado - Cerrado



12'80€

18'80€

11'80€

19'50€







## Modelos para W&amp;H®

Modelos para W&H®		Descripción
	Perfecta 300	<b>Medidas:</b> 4x9x4mm Liso Bola acero Cerrado - Cerrado
	<b>Ref.: 45-327</b>	<b>14'80€</b>

Rodamientos micromotor **NSK® ULTIMATE, VOLVERE Y UHR**

RUMAR



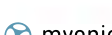

## Modelos para NSK®

Modelos para NSK®		Descripción
	Trasero eje	<b>Medidas:</b> 6X13x5mm Liso Bola acero Cerrado - Cerrado
	<b>Ref.: 45-220</b> (Ref. NSK: B11243-1306)	<b>9'80€</b>
	Delantero eje	<b>Medidas:</b> 6,35X12,7X4,763mm Liso Bola acero Cerrado - Cerrado
	<b>Ref.: 45-221</b> (Ref. NSK: B20245-2763)	<b>17'60€</b>
	Volvere rotor	<b>Medidas:</b> 3x7x3mm
	<b>Ref.: 30-683</b>	<b>14'80€</b>
	Ultimate rotor	<b>Medidas:</b> 4x9x4mm Liso Bola acero Cerrado - Cerrado
	<b>Ref.: 45-327</b>	<b>14'80€</b>

Rodamientos micromotor **SAEYANG MARATHON®**

RUMAR

## Modelos para Saeyang Marathon®

Modelos para Saeyang Marathon®			Descripción
	H20 H35SP1 H37L1 SH37L1	H37LN H37(L)SP H35LS M45	<b>Medidas:</b> 6x12x4mm Liso Bola acero Cerrado - Cerrado
	<b>Ref.: 45-233</b> (Ref. Marathon: 1260ZZ)		<b>17'80€</b>
	Eje trasero H20 Eje trasero H200 (12V) Eje trasero H200 (30V) Eje trasero H35SP1 Eje trasero H37L1	Eje trasero SH37L1 Eje trasero H37LN Eje trasero H37(L) SP Eje trasero H35LS Eje trasero M45	<b>Medidas:</b> 8x14x4mm <b>Velocidad:</b> 45.000 rpm Liso Bola acero Cerrado - Cerrado
	<b>Ref.: 45-234</b> (Ref. Marathon: 1480ZZ)	Eje trasero SH20N(30K) H300 (Ø3)	<b>17'80€</b>

Modelos para Saeyang®			Descripción	
 	SH37LN SH40C BM50S1	BM50K BS50C BM40S1	BM40C BHS1 BHK	<b>Medidas:</b> 6x13x5mm Liso Bola acero Cerrado - Cerrado
<b>Ref.: 45-220</b> (Ref. Marathon: 1360ZZ)			<b>9'80€</b>	
 	Delantero M20ES Delantero M25ES Delantero M33E Delantero M33ES Delantero M40ES Delantero H20 Delantero H200 (12V)	Delantero H200 (30V) Delantero H35SP1 Delantero H37L1 Delantero SH37L1 Delantero H37LN Delantero H37(L) SP Delantero H35LS	Delantero M45 Delantero SH20N (30K) Delantero SH37LN Delantero SH40C	<b>Medidas:</b> 3x10x4mm Liso Bola acero Abierto - Abierto
<b>Ref.: 45-302</b> (Ref. Marathon: 1030ZZ)			<b>12'20€</b>	
 	Trasero M20ES Trasero M25ES Trasero M33ES Trasero M40ES	Trasero H20 Trasero H200 (12V) Trasero H200 (30V) Trasero H37LN	Trasero H37(L) SP Trasero H35LS	<b>Medidas:</b> 3x8x4mm Liso Bola acero Cerrado - Cerrado
<b>Ref.: 30-2778</b> (Ref. Marathon: 830ZZ)			<b>18'80€</b>	

## ROTORES MICROMOTORES ELÉCTRICOS

RUMAR

### Rotores compatibles Micromotores **KaVo**<sup>®</sup>

	Descripción	Observaciones
	K190 K196 <b>Ref.: 30-101</b> (Ref. KaVo: 0.676.0871)	288 <sup>00</sup> €
	K192 <b>Ref.: 35-102</b> (Ref. KaVo: 0.676.0971)	288 <sup>00</sup> €
	K200 <b>Ref.: 30-103</b> (Ref. KaVo: 1.000.6859)	318 <sup>00</sup> €
	K201 <b>Ref.: 30-104</b> (Ref. KaVo: 1.001.8992)	318 <sup>00</sup> €
	K9 EWL 950 K9 EWL 955 <b>Ref.: 30-110</b> (Ref. KaVo: 0.674.1261 / 1.000.2200)	266 <sup>00</sup> €
	K10 <b>Ref.: 30-111</b> (Ref. KaVo: 0.674.3321)	388 <sup>00</sup> €

### Rotores compatibles Micromotores **Bien Air**<sup>®</sup>

RUMAR

	Descripción	Observaciones
	MC3 <b>Ref.: 30-117</b> (Ref. Bien Air: 150.00.42 / 211.75.29 + 701.01.71 + 701.01.70)	Incluye: disco teflón, arandelas y rodamientos. 348 <sup>00</sup> €
	MC2 40 IR <b>Ref.: 30-118</b> (Ref. Bien Air: 150.09.32 / 211.36.04)	348 <sup>00</sup> €
	MC2 40 LKE <b>Ref.: 30-119</b> (Ref. Bien Air: 150.09.31 / 211.61.16)	348 <sup>00</sup> €

### Rotores compatibles Micromotores **W&H**<sup>®</sup>

RUMAR

	Descripción	Observaciones
	EB40 <b>Ref.: 30-117</b> (Ref. W&H: 04059300)	Incluye: disco teflón, arandelas y rodamientos. 348 <sup>00</sup> €

Rotores compatibles Micromotores **Saeyang Marathon®**, **Saeshin®**

RUMAR

Descripción	Observaciones
 <p>E Motor SDE-M33ES.</p> <p><b>Ref.: 30-120</b> <b>80<sup>00</sup>€</b></p>	

Rotores Micromotores **MK-dent®**





Descripción	Observaciones
 <p>MK-dent EM1190K.</p> <p><b>Ref.: 05-RO1190MK</b> <b>298<sup>00</sup>€</b></p>	

## ESCOBILLAS MICROMOTORES ELÉCTRICOS



Escobillas compatibles Micromotores **KaVo®**

RUMAR

Descripción	Observaciones
 <p>Motores INTRA: K191 K196 K200 K190 K192 K197 K201</p> <p><b>Ref.: 30-260</b> (Ref. KaVo: 0.676.0881) <b>11<sup>60</sup>€</b></p>	1 unidad
 <p>K9</p> <p><b>Ref.: 30-250</b> (Ref. KaVo: 0.676.0241) <b>11<sup>50</sup>€</b></p>	1 unidad
 <p>K10</p> <p><b>Ref.: 30-251</b> (Ref. KaVo: 0.674.2481) <b>12<sup>10</sup>€</b></p>	1 unidad

Escobillas Micromotores **NSK®**

RUMAR

Descripción	Observaciones
 <p>Volvere y M40 <b>***Original NSK***</b></p> <p><b>Ref.: 30-275</b> (Original Ref. NSK: E023011S) <b>59<sup>80</sup>€</b></p>	Pack 2 uds
 <p>MX90 459TM 459L</p> <p><b>Ref.: 31-270</b> <b>10<sup>80</sup>€</b></p>	1 unidad



Escobillas compatibles Micromotores **W&H®**

RUMAR

Descripción	Observaciones
 <p>ELCO</p> <p><b>Ref.: 80-400026</b> <b>22<sup>80</sup>€</b></p>	1 unidad



Escobillas Micromotores **Bien Air®**

RUMAR

Descripción		Observaciones
	MC2 <b>***Original Bien Air***</b> Ref.: <b>30-264</b> (Ref. Bien Air: 211.45.06) 1 unidad	1 unidad <b>23´90€</b>
	MC3 <b>***Original Bien Air***</b> Ref.: <b>30-265</b> (original, Ref. Bien Air: 211.75.08)	1 unidad <b>23´90€</b>
	MC3 <b>***Compatible***</b> Ref.: <b>30-268</b> (Ref. Bien Air: 211.75.08)	1 unidad <b>16´80€</b>

Escobillas Micromotores **FARO®**

FARO

Descripción		Observaciones
	Única Ref.: <b>80-406117</b> (Ref. Faro: 556117)	1 unidad <b>28´00€</b>
	Modo Ref.: <b>80-407540</b> (Ref. Faro: SP557540)	Pack 4 unidades <b>70´80€</b>

Escobillas Compatibles Micromotores **Saeyang Marathon®, Saeshin®**

RUMAR

Descripción		Observaciones
	Marathon Saeshin Ref.: <b>31-270</b>	1 unidad <b>10´80€</b>

Escobillas Micromotores **MK-dent®**

MK-dent

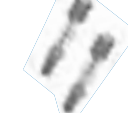
Descripción		Observaciones
	EM1190K. (Pack 2 uds) Ref.: <b>05-SP1219/2</b>	Pack 2 unidades <b>25´80€</b>



## PINZAS MICROMOTORES

Pinzas compatibles Micromotores **KaVo®**

RUMAR



Descripción		Observaciones
	2.35 mm K11 K9 EWL 950 (antiguo) K9 EWL 955 (antiguo) K10 4950 Ref.: <b>30-401</b> (Ref. KaVo: 0.674.7752)	<b>48´50€</b>



		Descripción	Observaciones
	2,35 mm	K10 (excepto 4950) K12 K4 K5 K9 EWL 4930 nuevo (azul) K9 EWL 4932 nuevo (azul)	K9 EWL 4933 nuevo (azul) Power Grip todos los modelos Ref.: <b>30-402</b> (Ref. KaVo: 0.674.4871) <b>52'80€</b>
	2,35 mm	SF EWL 4004 SF EWL 4005 Ref.: <b>45-444</b> (Ref. KaVo: 0.671.1562)	<b>42'80€</b>

Pinzas compatibles Micromotores **NSK®**

RUMAR

		Descripción	Observaciones
	2,35 mm	Ultimate XL 450 500 Volvere Vmax Ref.: <b>30-405</b> (Ref.NSK H203180)	<b>48'00€</b>
		Presto Aqua Lux Aqua II Presto II Ref.: <b>30-407</b> (Ref.NSK T815019)	<b>42'80€</b>

Pinzas micromotores **W&H®**

RUMAR

		Descripción	Observaciones
	2,35 mm	Perfecta (desde N/S 011117). ***Original W&H*** Ref.: <b>30-5500</b> (original, Ref W&H: 03205500)	<b>66'80€</b>

Pinzas compatibles micromotores **Marathon®**

RUMAR

		Descripción	Observaciones
	2,35 mm	Marathon. Ref.: <b>30-406</b>	<b>29'80€</b>

## TAPAS - CASQUILLOS

Micromotores **KaVo®**



RUMAR

		Descripción	Observaciones
		Tapa K9, K10 (Gris) Ref.: <b>30-439</b> (Ref. KaVo: 0.674.2861)	<b>31'90€</b>
		Casquillo K9, K10. Ref.: <b>45-440</b> (Ref. KaVo: 0.674.6302)	<b>10'80€</b>
		Tapa pinzas K4, K5, K9, K10, K11, K12. Ref.: <b>30-409</b> (Ref. KaVo: 0.674.8212)	<b>3'80€</b>

## VARILLAS - TOPES DE ARRASTRE



### Micromotores KaVo®

RUMAR

	Descripción	Observaciones
	Varilla de sujeción K9, K10. <b>Ref.: 30-420</b> (Ref. KaVo: 0.674.1191)	20'90€
	Varilla de sujeción SF EWL 4004 Varilla de sujeción SF EWL 4005 <b>Ref.: 45-441</b> (Ref. KaVo: 0.674.3052)	39'80€
	Tope de arrastre varilla K9, K10, K11. <b>Ref.: 30-430</b> (Ref. KaVo: 0.674.4192)	25'80€
	Pasador tope de arrastre todos los modelos. ***Original KaVo*** <b>Ref.: 20-432</b> (Ref. KaVo: 0.202.0018)	2'30€

### Micromotores Bien Air®

RUMAR



	Descripción	Observaciones
	Pasador tope de arrastre MC2, clavija elástica 1x5. ***Original Bien Air*** <b>Ref.: 30-165</b> (Ref. Bien Air: 652.02.02 / 1300664)	3'80€
	Pasador tope de arrastre MC3, clavija elástica. ***Original Bien Air*** <b>Ref.: 30-166</b> (Ref. Bien Air: 652.04.05)	4'80€

## ARANDELAS - ANILLOS TÓRICOS

### Micromotores KaVo®

RUMAR



	Descripción	Observaciones
	Arandela elástica K9, K10, K11. <b>Ref.: 45-4057</b> (Ref. KaVo: 0.222.4057)	1'00€ <span style="background-color: yellow;">HASTA AGOTAR</span>
	Arandela elástica K9, K12. <b>Ref.: 45-4044</b> (Ref. KaVo: 0.222.4044)	1'00€ <span style="background-color: yellow;">HASTA AGOTAR</span>
	Arandela elástica K9, K10. <b>Ref.: 45-4045</b> (Ref. KaVo: 0.222.4045)	1'00€ <span style="background-color: yellow;">HASTA AGOTAR</span>
	Anillo tórico K9, K10. <b>Ref.: 45-2408</b> (Ref. KaVo: 0.224.2408)	0'90€

	Descripción	Observaciones
	Anillo fieltro 8,1 K11. <b>Ref.: 45-0827</b> (Ref. KaVo: 0.224.0827)	1'10€
	Anillo tórico K4, K5, K9. <b>Ref.: 30-445</b> (Ref. KaVo: 0.200.6199)	1'00€

## TOPES DE ARRASTRE

Micromotores KaVo®





RUMAR

	Descripción	Observaciones
	190 192 <b>Ref.: 45-005</b> (Ref. KaVo: 0.535.1352)	196 K200 K201 KL700 KL701 19'80€
	Pasador tope de arrastre todos los modelos. <b>Ref.: 20-432</b> (Ref. KaVo: 0.202.0018)	Medidas: 1x4,5mm 2'30€

## LÁMINAS - COJINETES - TUERCAS - TAPAS

Micromotores KaVo®

RUMAR

	Descripción	Observaciones
	Lámina SF EWL 4004 Lámina SF EWL 4005 <b>Ref.: 45-442</b> (Ref. KaVo: 0.674.3062)	33'80€
	Cojinete guía alta frecuencia SF EWL 4004 Cojinete guía alta frecuencia SF EWL 4005 <b>Ref.: 45-443</b> (Ref. KaVo: 0.674.0532)	48'80€
	Ventilador SF EWL 4004 Ventilador SF EWL 4005 <b>Ref.: 45-451</b> (Ref. KaVo: 0.674.2911)	16'80€
	Tuerca roscada: <b>Ref.: 30-255</b> (Ref. 1.000.1260)	K9 EWL 4930 nuevo (azul) K9 EWL 4932 nuevo (azul) K9 EWL 4933 nuevo (azul) K12 9'80€

HASTA AGOTAR



Otros Repuestos Micromotores FARO®



	Descripción	Observaciones
	Cable micromotor Modo.  <b>Ref.: 80-400000</b> (Ref. Faro: 557300000) <span style="float: right;"><b>209<sup>80</sup>€</b></span>	<span style="float: right;"><b>BAJO PEDIDO</b></span>

Otros repuestos micromotores MK-dent®



	Descripción	Observaciones
 <small>Imagen no disponible</small>	Anillo tórico EM1190K (1ud.)  <b>Ref.: 05-SP1222</b> <span style="float: right;"><b>1<sup>50</sup>€</b></span>	
 <small>Imagen no disponible</small>	Anillo tórico EM1190K (1ud.)  <b>Ref.: 05-SP1228</b> <span style="float: right;"><b>1<sup>00</sup>€</b></span>	
 <small>Imagen no disponible</small>	Muelle EM1190K (1ud.)  <b>Ref.: 05-SP1210</b> <span style="float: right;"><b>1<sup>50</sup>€</b></span>	



## REPUESTOS LÁMPARAS FARO



- 1.- Repuestos lámpara Alya
- 2.- Repuestos lámpara Maia
- 3.- Repuestos lámpara EDI
- 4.- Repuestos lámpara Forma y otras



## Repuestos Lámparas FARO

### Alya, Alya-Theia, Alya CAM

80-010108	Palanca interruptor lámpara Alya (Ref.: Faro SP310108)	€ 18,80
80-010025	Pareja reflectores lámpara Alya (N/S<10LD012150) (Ref. Faro SP310025)	€ 85,80
80-010025006	Pareja reflectores lámpara Alya (N/S>10LD012150) (Ref. Faro SP310025006)	€ 85,80
80-010370*	Kit asas grises (derecha + izquierda) lámpara Alya (N/S: desde 11LD005228) (Ref. Faro SP310370) <b>* Hasta agotar existencias</b>	€ 113,80
80-010390006	Kit soportes y asas blancas (derecha + izquierda) lámpara Alya (Todas) (Ref. Faro SP310390006=SP310352006+SP310370006)	€ 156,80
80-010352006	Kit soportes asas blancas (derecha + izquierda) lámpara Alya (N/S: desde 11LD005228) (Ref. Faro SP310352006)	€ 39,80
80-010370006	Kit asas blancas (derecha + izquierda) lámpara Alya (N/S: desde 11LD005228) (Ref. Faro SP310370006)	€ 122,80
80-010102	Grupo electrónico joystick lámpara Alya (Ref. Faro SP310102)	€ 69,80
80-010200	Grupo LED lámpara Alya (N/S: hasta 10LD012150) (Ref. Faro SP310200)	€ 403,80
80-010305	Grupo LED lámpara Alya (N/S: 10LD012151 – 15LD005043) (Ref. Faro SP310305)	€ 403,80
80-010435	Grupo LED lámpara Alya (N/S: 15LD005044 – 17LD010112) (Ref. Faro SP310435)	€ 403,80
80-010285	Grupo LED lámpara Alya (N/S: desde 17LD010113) (Ref. Faro SP510285)	€ 418,80
80-010125	Placa electrónica lámpara Alya con interruptor y carcasa gris (N/S: <10LD012150) (Ref. Faro SP310125)	€ 301,80
80-010130	Placa electrónica lámpara Alya con sensor y carcasa gris (N/S: <10LD012150) (Ref. Faro SP310130)	€ 389,80 → 
80-010355006	Placa electrónica lámpara Alya con interruptor y carcasa "blanca" (10LD012151<N/S<15LD005043) (Ref. Faro SP310355006)	€ 289,80 <i>En stock!</i>

80-010360006	Placa electrónica lámpara Alya con sensor y carcasa " <u>blanca</u> " (10LD012151<N/S<15LD005043) (Ref. Faro SP310360006)	€ 389,80 → 
80-010480006	Placa electrónica lámpara Alya con interruptor y carcasa " <u>blanca</u> " (15LD005044<N/S<17LD010112) (Ref. Faro SP310480006)	€ 289,80 <i>En stock!</i>
80-010485006	Placa electrónica lámpara Alya con sensor y carcasa " <u>blanca</u> " (15LD005044<N/S<17LD010112) (Ref. Faro SP310485006)	€ 389,80 → 
80-010125B	Placa electrónica lámpara Alya con interruptor y carcasa " <u>blanca</u> " (N/S>17LD010113) (Ref. Faro SP510125B)	€ 301,80 <i>En stock!</i>
80-010130B	Placa electrónica lámpara Alya con sensor y carcasa " <u>blanca</u> " (N/S>17LD010113) (Ref. Faro SP510130B)	€ 391,80 → 

## Maia

80-030908	Palanca interruptor lámpara Maia, 1ud. (Ref. Faro SP320908/5)	€ 5,30
80-030907	Interruptor con palanca lámpara Maia (N/S<15LD011296) (Ref. Faro SP320907)	€ 89,80
80-030907A	Interruptor con palanca lámpara Maia (N/S>15LD011296) (Ref. Faro SP320907A)	€ 89,80
80-030902	Pareja reflectores lámpara Maia (Ref. Faro SP320902)	€ 78,80
80-026365	Kit asas (derecha + izquierda) lámpara EDI y Maia (Ref. Faro 306365; 320904)	€ 94,80
80-030905	Kit soportes (derecha + izquierda) lámpara Maia (1 pareja) (Ref. Faro SP320905)	€ 8,80
80-030095	Cable de grupo LED a placa electrónica lámparas Maia y Alya (Ref. Faro 310095)	€ 28,80
80-030903	Grupo LED Maia (Ref. Faro SP320903)	€ 301,80
80-030906	Placa electrónica lámpara Maia (N/S<15LD011296) (Ref. Faro SP320906)	€ 245,80
80-030906A	Placa electrónica lámpara Maia (N/S>15LD011296) (Ref. Faro SP320906A)	€ 289,810

## EDI

80-029005	Interruptor bipolar lámpara EDI (Ref. Faro SP409005)	€ 24,80
80-026001	Reflector lámpara EDI (Ref. Faro 306001)	€ 124,80
80-026029	Protección frontal lámpara EDI (Ref. Faro 306029)	€ 62,80
80-026027	Protector bombilla lámpara EDI (Ref. Faro 306027)	€ 20,80
80-026364	Kit soportes (derecha + izquierda) lámpara EDI (Ref. Faro 306364=306035+306038)	€ 40,80
80-026365	Kit asas (derecha + izquierda) lámpara EDI y Maia (Ref. Faro 306365; 320904)	€ 94,80
80-026032	Protector térmico lámpara EDI (Ref. Faro 306032)	€ 12,80
80-026053	Regulador intensidad lámpara EDI (Ref. Faro 306053)	€ 30,80
80-026076	Asa inferior lámpara EDI (Ref. Faro 306076)	€ 31,80
80-026079	Ventilador lámpara EDI (Ref. Faro 306079)	€ 51,80
80-026080	Electrónica ventilador lámpara EDI (Ref. Faro 306080)	€ 33,80
80-026019	Porta lámparas lámpara EDI (Ref. Faro 306019)	€ 18,80
 80-021122	Bombilla 17V 95W lámpara EDI // Castellini Venus (Ref. Faro 401122)	€ 10,80

## Forma, S90, SC y TS90

 80-64643FDS	Bombilla OSRAM 24V 150W casquillo cerámico (Ref. Faro 406022)	€ 23,80
80-058116	Interruptor unipolar lámparas Forma con transformador (Ref. Faro 408116)	€ 16,80
80-055255	Reflector parabólico lámparas Forma 2000/90 (Ref. Faro 305255)	€ 308,00
80-058013	Plexiglas protección frontal lámparas Forma 90 (Ref. Faro 408013)	€ 72,80



80-058858	Plexiglas protección frontal lámparas Forma 2000 (Ref. Faro SP408858)	€ 50,80
80-055252	Baffle blanco lámparas Forma 2000/90 (Ref. Faro 305252)	€ 12,80
80-055259	Termostato con reset manual (Ref. Faro 305259)	€ 30,80
80-058877	Regulador intensidad lámparas Forma 2000/90 (Ref. Faro 408877)	€ 15,80
80-055284	Electrónica con ventilador lámparas Forma 2000/90 (Ref. Faro 305284)	€ 111,80
80-058005	Porta lámparas lámparas Forma 2000/90 (Ref. Faro 408005)	€ 40,80
80-050088	Transformador lámparas Forma 2000/90 (Ref. Faro 300088)	€ 132,80 → 

**OTRAS REFERENCIAS DISPONIBLES CONSÚLTANOS**



## BOMBILLAS EQUIPOS / APARATOS

**PARA MÁS VER SECCIÓN FARO**

17-222*	12V/55W Daray Bifocal	€ 68,00
13165*	Phillips 14V, 35W	€ 38,00
09-900*	Decostar 51	€ 14,50
588290E*	OSRAM 58.8290W, 230V, 150W (para Ritter)	€ 58,00

**\* Hasta agotar existencias**



# REPUESTOS AUTOCLAVES Y SELLADORAS



## REPUESTOS AUTOCLAVES Repuestos Autoclaves FARO

80-302705	Kit mantenimiento autoclave Faro SK07, Moon, Step, Easy-R (Ref. Faro SP742705) <u>Suministro incluye:</u> 2x filtros agua (Ref. Faro 707175X2), junta puerta (Ref. Faro 708014), filtro caldera (Ref. Faro 737068), tubos carga y descarga (Ref. Faro 742589) y filtro bacteriológico (Ref. Faro 742631).	€ 106,80
80-308014	Junta puerta autoclave Faro SK07, Moon, Step, Easy-R, Just (Ref. Faro SP708014)	€ 43,80
80-300067	Junta puerta autoclave Faro Nisea (Ref. Faro SP750067)	€ 19,80
80-307175	Filtro agua autoclave Faro SK07 ( <u>pack: 2 uds</u> ) (Ref. Faro SP707175)	€ 20,80
80-302592	Tubos de carga y descarga autoclaves Faro (Ref. Faro SP742592)	€ 26,80
	70-0004 Filtro bacteriológico <u>autoclaves "todos los modelos"</u> (Ref. Faro 742631/3, 737079)	€ 18,00

**OTRAS REFERENCIAS DISPONIBLES CONSÚLTANOS**

## Filtros bacteriológicos autoclaves



70-0004	Filtro bacteriológico autoclave 1/8" (33,5mm alto x 54,0mm ancho) Utilizado en autoclaves: Comminox, Mocom, Tecnogaz, W&H (algunos modelos), Satelec Acteon, NSK (algunos modelos)	€ 18,00
---------	--	---------



70-0008	Filtro bacteriológico autoclave 1/8" (25,5mm alto x 54,0mm ancho) Utilizado en autoclaves: Euronda, Icanclave, W&H (algunos modelos), NSK (algunos modelos)	€ 18,00
---------	---	---------

## REPUESTOS SELLADORAS



## Repuestos Selladoras FARO

80-700301	Cuchilla selladora Sella II (con soporte) (Ref. Faro SP700301)	€ 50,80
80-700353	Cuchilla selladora SL13 (sin soporte) (Ref. Faro SP700353)	€ 45,80

# RUMAR

mayorista dental

## JERINGAS Y REPUESTOS JERINGAS

- 1.- Jeringas Luzzani y sus repuestos
- 2.- Jeringas FARO y sus repuestos
- 3.- Jeringas económicas



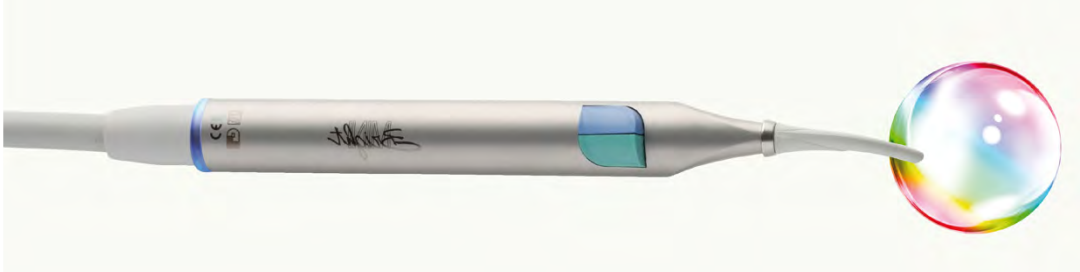

### JERINGAS LUZZANI MINIBRIGHT

39-3151      Jeringa Minibright 6F, con luz, recta, Acero / gris, 170cm    € 414,80

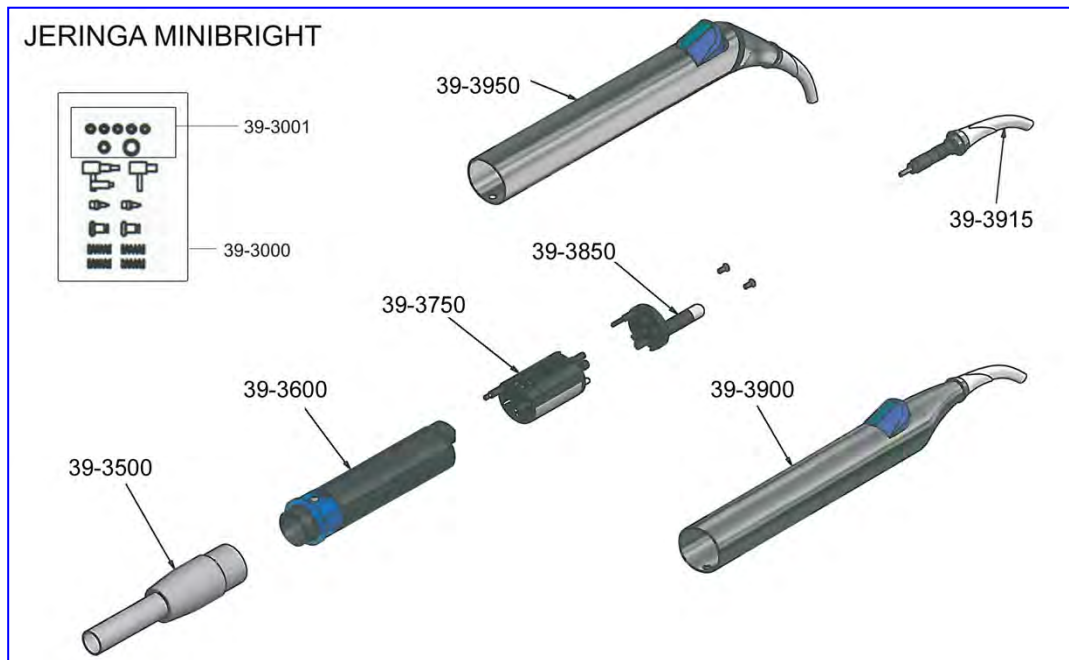

REPUESTOS JERINGAS LUZZANI MINIBRIGHT, F6 Y EFFE 6 BEI

39-3915	Punta jeringa Minibright	€	19,80
39-3000	Kit completo reparación Minibright	€	46,80
39-3001	Kit completo anillos tóricos Minibright	€	15,80
39-3750	Cabeza completa Minibright	€	167,80
39-3850	LED Minibright	€	62,80
39-3600	Cuerpo central Minibright	€	116,80
39-3500	Manguera completa jeringa Minibright, gris, 170cm	€	93,80
39-3900	Carcasa completa Minibright	€	148,00

**TODOS LOS REPUESTOS JERINGAS LUZZANI CONSULTE PRECIOS Y DESPIECES**

Consulta por las  
puntas desechables

**Pro-Tip<sup>®</sup>TURBO**  
by Astek Innovations Ltd





### JERINGAS LUZZANI MINILIGHT (OPEN END)

39-12521	Jeringa Minilight 3F, recta, Acero / gris, 170cm	€ 246,80
39-12621	Jeringa Minilight 3F, angulada, Acero / gris, 170cm	€ 246,80
39-12523*	Jeringa Minilight 3F, recta, Acero / negra, 170cm <i>* Hasta agotar existencias</i>	€ 228,00
39-11521	Jeringa Minilight 6F, recta, Acero / gris, 170cm	€ 308,00
39-11621	Jeringa Minilight 6F, angulada, Acero / gris, 170cm	€ 338,00

### JERINGAS LUZZANI MINILIGHT (CONECTOR A EQUIPO CEFLA DESDE 2006: CASTELLINI, ANTHOS, STERN WEBER)

39-12521C1	Jeringa Minilight 3F, recta, Acero / gris, 120cm <u>Conector equipo Cefla7</u>	€ 378,00
39-12521C2	Jeringa Minilight 3F, recta, Acero / gris, 135cm <u>Conector equipo Cefla</u>	€ 378,00
39-12621C1	Jeringa Minilight 3F, angulada, Acero / gris, 120cm <u>Conector equipo Cefla</u>	€ 398,00
39-12621C2	Jeringa Minilight 3F, angulada, Acero / gris, 135cm <u>Conector equipo Cefla</u>	€ 398,00
39-11521C1	Jeringa Minilight 6F, recta, Acero / gris, 120cm <u>Conector equipo Cefla</u>	€ 504,80 → 
39-11521C2	Jeringa Minilight 6F, recta, Acero / gris, 135cm <u>Conector equipo Cefla</u>	€ 504,80 → 

39-11621C1 Jeringa Minilight 6F, angulada, Acero / gris, 120cm € 528,00→   
Conector equipo Cefla

39-11621C2 Jeringa Minilight 6F, angulada, Acero / gris, 135cm € 528,00→   
Conector equipo Cefla

JERINGAS LUZZANI MINILIGHT (CONECTOR A EQUIPO KAVO)

39-12521K1 Jeringa Minilight 3F, recta, Acero / gris, 120cm € 378,00  
Conector equipo KaVo "Excepto" E30, E50, E70, E80,  
1058 Primus Life (Serie 1)

39-12521K2 Jeringa Minilight 3F, recta, Acero / gris, 135cm € 378,00  
Conector equipo KaVo "Excepto" E30, E50, E70, E80,  
1058 Primus Life (Serie 1)

39-12521K3 Jeringa Minilight 3F, recta, Acero / gris, 120cm € 380,00  
Conector equipo KaVo E30, E50, E70, E80, 1058 Primus Li80  
(Serie 2)

39-12521K4 Jeringa Minilight 3F, recta, Acero / gris, 135cm € 380,00→   
Conector equipo KaVo E30, E50, E70, E80, 1058 Primus Life  
(Serie 2)

39-12621K1 Jeringa Minilight 3F, angulada, Acero / gris, 120cm € 398,00  
Conector equipo KaVo "Excepto" E30, E50, E70, E80,  
1058 Primus Life (Serie 1)

39-12621K2 Jeringa Minilight 3F, angulada, Acero / gris, 135cm € 398,00  
Conector equipo KaVo "Excepto" E30, E50, E70, E80,  
1058 Primus Life (Serie 1)

39-11521K1 Jeringa Minilight 6F, recta, Acero / gris, 120cm € 528,00→   
Conector equipo KaVo "excepto" E30, E50, E70, E80,  
1058 Primus Life (Serie 1)

39-11521K2 Jeringa Minilight 6F, recta, Acero / gris, 135cm € 528,00→   
Conector equipo KaVo "excepto" E30, E50, E70, E80,  
1058 Primus Life (Serie 1)

39-11621K1 Jeringa Minilight 6F, angulada, Acero / gris, 120cm € 528,00→   
Conector equipo KaVo "excepto" E30, E50, E70, E80,  
1058 Primus Life (Serie 1)

39-11621K2 Jeringa Minilight 6F, angulada, Acero / gris, 135cm € 528,00→   
Conector equipo KaVo "excepto" E30, E50, E70, E80,  
1058 Primus Life (Serie 1)



39-11521K3	Jeringa Minilight 6F, recta, Acero / gris, 120cm <u>Conector equipo KaVo E30, E50, E70, E80, 1058 Primus Life (Serie 2)</u>	€ 518,00→	
39-11521K4	Jeringa Minilight 6F, recta, Acero / gris, 135cm <u>Conector equipo KaVo E30, E50, E70, E80, 1058 Primus Life (Serie 2)</u>	€ 518,00→	
39-11621K3	Jeringa Minilight 6F, angulada, Acero / gris, 120cm <u>Conector equipo KaVo E30, E50, E70, E80, 1058 Primus Life (Serie 2)</u>	€ 548,00→	
39-11621K4	Jeringa Minilight 6F, angulada, Acero / gris, 135cm <u>Conector equipo KaVo E30, E50, E70, E80, 1058 Primus Life (Serie 2)</u>	€ 548,00→	

## JERINGA MINILIGHT 3F

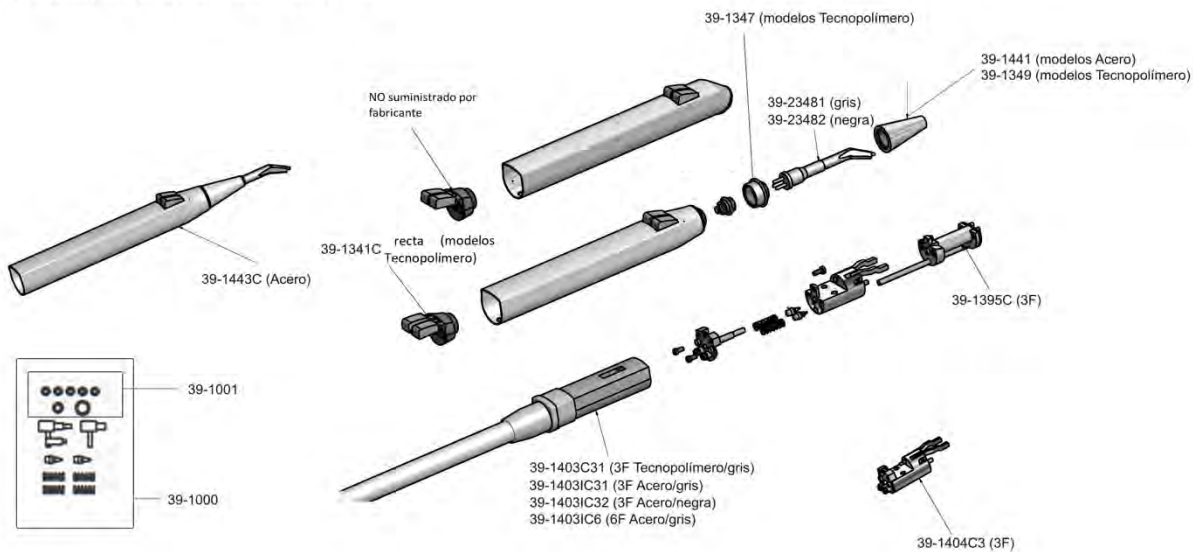

Consulta por las  
puntas desechables  
**Pro-Tip<sup>®</sup>TURBO**  
by Astek Innovations Ltd

### REPUESTOS JERINGAS LUZZANI MINILIGHT

39-1000	Kit completo reparación	€ 30,80
39-1001	Kit completo 18 anillos tóricos	€ 15,80
39-1395C	Cabeza completa 3F	€ 68,00
39-1403IC31	Manguera completa jeringa 3F de Acero, gris, 170cm	€ 66,80
39-1403IC6	Manguera completa jeringa 6F de Acero, gris, 170cm	€ 125,80
39-1404C3	Cuerpo jeringa 3F ( <u>NO 6F</u> )	€ 112,80
39-1404	Cuerpo jeringa 6F	€ 112,80
39-1441	Cono Acero	€ 13,80
39-1443C	Carcasa completa recta Acero	€ 109,80
39-1451C	Carcasa completa angulada Acero	€ 135,80
39-23481	Punta gris	€ 18,00
39-1400	Adaptador jeringas Minilight Tecnopolímero a Acero	€ 6,80

**TODOS LOS REPUESTOS JERINGAS LUZZANI CONSULTE PRECIOS Y DESPIECES**

Consulta por las  
puntas desechables

**Pro-Tip<sup>®</sup> TURBO**  
by Astek Innovations Ltd

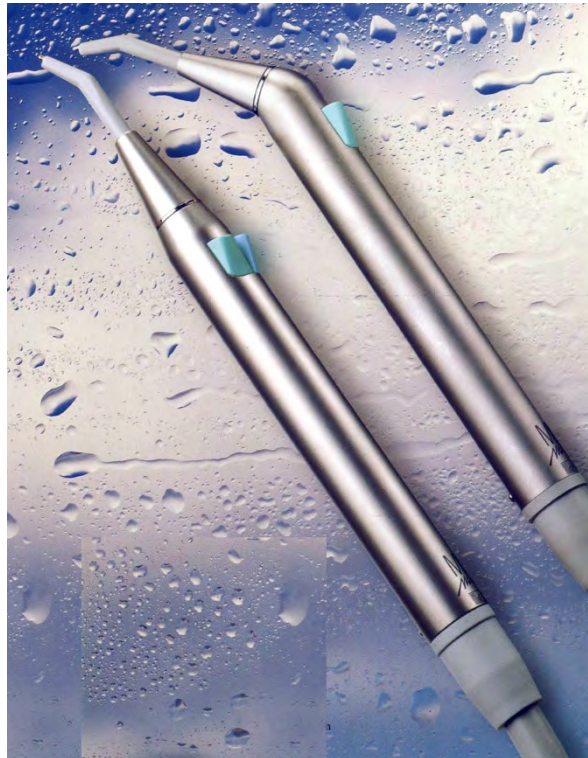

#### JERINGAS LUZZANI MINIMATE (OPEN END)

39-251	Jeringa Minimate 3F, recta, Acero / gris, 170cm	€ 198,00
39-261	Jeringa Minimate 3F, angulada, Acero / gris, 170cm	€ 198,00
39-2612*	Jeringa Minimate 3F, angulada, Acero / negra, 170cm * Hasta agotar existencias	€ 188,00

#### JERINGAS LUZZANI MINIMATE (CONECTOR A EQUIPO CEFLA DESDE 2006: CASTELLINI, ANTHOS, STERN WEBER)

39-251C1	Jeringa Minimate 3F, recta, Acero / gris, 120cm, <u>Conector equipo Cefla</u>	€ 308,00
39-251C2	Jeringa Minimate 3F, recta, Acero / gris, 135cm, <u>Conector equipo Cefla</u>	€ 308,00
39-261C1	Jeringa Minimate 3F, angulada, Acero / gris, 120cm <u>Conector equipo Cefla</u>	€ 328,00
39-261C2	Jeringa Minimate 3F, angulada, Acero / gris, 135cm <u>Conector equipo Cefla</u>	€ 328,00

JERINGAS LUZZANI MINIMATE (CONECTOR A EQUIPO KAVO)

39-251K1	Jeringa Minimate 3F, recta, Acero / gris, 120cm, <u>Conector equipo KaVo "Excepto" E30, E50, E70, E80, 1058 Primus Life (Serie 1)</u>	€ 308,00
39-251K2	Jeringa Minimate 3F, recta, Acero / gris, 135cm, <u>Conector equipo KaVo "Excepto" E30, E50, E70, E80, 1058 Primus Life</u>	€ 308,00
39-251K3	Jeringa Minimate 3F, recta, Acero / gris, 120cm, <u>Conector equipo KaVo E30, E50, E70, E80, 1058 Primus Life (Serie 2)</u>	€ 318,00
39-251K4	Jeringa Minimate 3F, recta, Acero / gris, 135cm, <u>Conector equipo KaVo E30, E50, E70, E80, 1058 Primus Life (Serie 2)</u>	€ 318,00 → 
39-261K1	Jeringa Minimate 3F, angulada, Acero / gris, 120cm <u>Conector equipo KaVo "Excepto" E30, E50, E70, E80, 1058 Primus Life (Serie 1)</u>	€ 328,00
39-261K2	Jeringa Minimate 3F, angulada, Acero / gris, 135cm <u>Conector equipo KaVo "Excepto" E30, E50, E70, E80, 1058 Primus Life</u>	€ 328,00

**TODOS LOS REPUESTOS JERINGAS LUZZANI CONSULTE PRECIOS Y DESPIECES**

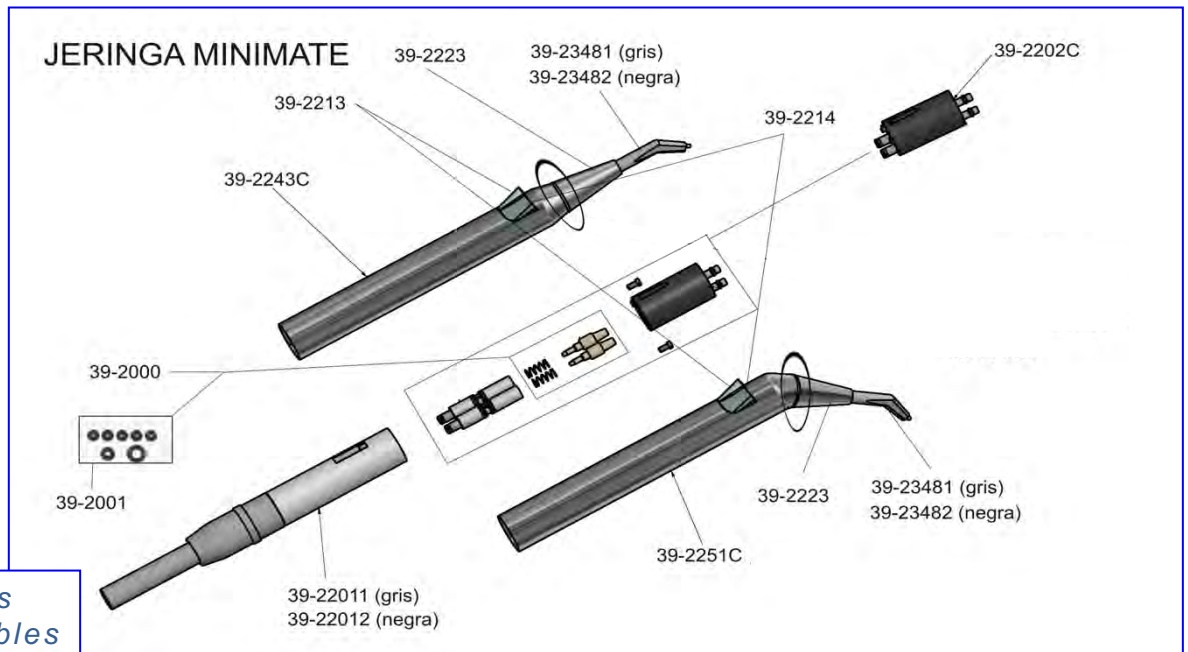

Consulta por las  
puntas desechables  
**Pro-Tip TURBO**  
by Astek Innovations Ltd

### REPUESTOS JERINGAS LUZZANI MINIMATE

39-2000	Kit completo reparación	€ 31,80
39-22011	Manguera completa para jeringa 3F de Acero, gris, 170cm	€ 65,80
39-22012*	Manguera completa para jeringa 3F de Acero, negra, 170cm * Hasta agotar existencias	€ 63,00
39-2202C	Cuerpo jeringa 3F	€ 94,80
39-2223	Cono Acero	€ 13,80
39-2243C	Carcasa completa recta Acero	€ 102,80
39-2251C	Carcasa completa angulada Acero	€ 113,80
39-23481	Punta gris	€ 18,00

**TODOS LOS REPUESTOS JERINGAS LUZZANI CONSULTE PRECIOS Y DESPIECES**

**LUZZANI  
DENTAL**



### JERINGAS LUZZANI MINIASSISTANT

39-0621	Jeringa Miniassistant 3F, angulada, Acero / gris, 170cm	€ 104,80
---------	---	----------

Consulta por las  
puntas desechables

**Pro-Tip<sup>®</sup>TURBO**  
by Astek Innovations Ltd

**FARO**



### JERINGAS FARO SEM3

80-501940 Jeringa Faro SM3 3F, angulada, metal / gris  
(Ref. Faro 091940)

€ 399,80 →



### REPUESTOS JERINGAS FARO SEM3

80-501291 Medios aire/agua  
(Ref. Faro SP091291)

€ 25,80

**OTRAS REFERENCIAS DISPONIBLES CONSÚLTANOS**

Consulta por las  
puntas desechables

**Pro-Tip<sup>®</sup>TURBO**  
by Astek Innovations Ltd

**FARO**



### JERINGAS FARO SYR3

80-500101	Jeringa Faro SYR3, angulada, Acero / gris (Ref. Faro 094000101)	€ 215,80
80-500100	Jeringa Faro SYR3, recta, Acero / gris (Ref. Faro 094000100)	€ 215,80



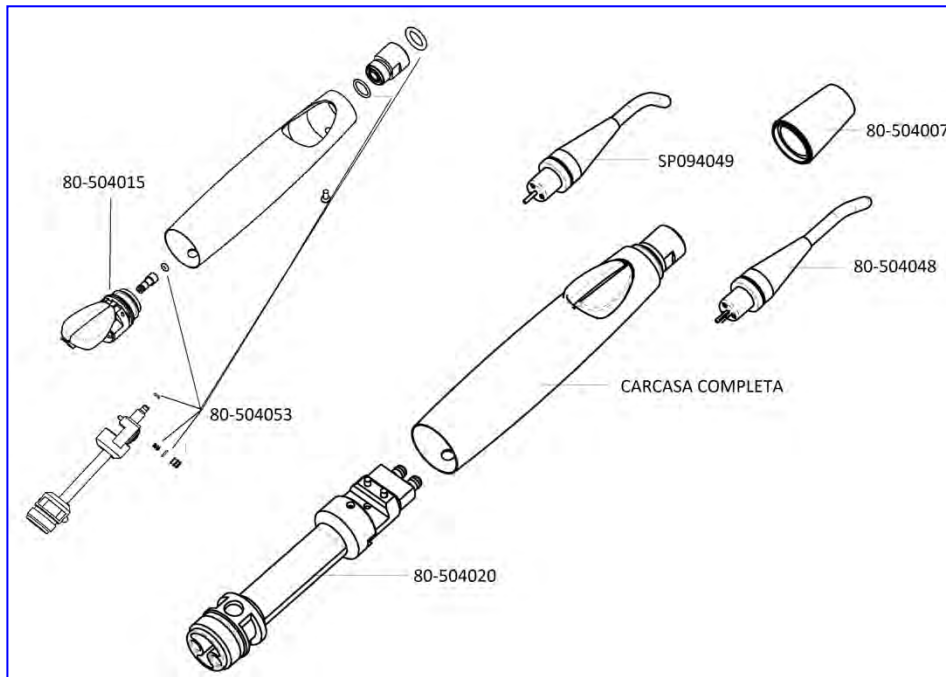

Consulta por las  
puntas desechables  
**Pro-Tip<sup>®</sup>TURBO**  
by Astek Innovations Ltd

### REPUESTOS JERINGAS FARO SYR3

80-504007	Cono acero (Ref. Faro SP094007)	€ 24,80
80-504015	Botonera aire/agua jeringa ( <u>1uds.</u> ) (Ref. Faro SP094015 /3)	€ 22,80
80-504020	Cuerpo jeringa (Ref. Faro SP094020)	€ 141,80
80-504048	Punta recta gris jeringa (Ref. Faro SP094048)	€ 38,80
80-504053	Kit completo reparación jeringa (Ref. Faro SP094053)	€ 59,80

**OTRAS REFERENCIAS DISPONIBLES CONSÚLTANOS**



## JERINGAS DE ACERO ECONÓMICAS



44-280 Jeringa de acero, 3F angulada (No manguera)\* € 32,80



44-281 Jeringa de acero, 3F recta (No manguera)\* € 32,80



44-285 Cánulas de repuesto, esterilizables € 2,80

**\*Ver manguera REF. 40-61A2000**



## MANGUERAS EQUIPOS

- 1.- Mangueras turbinas con y sin conector a equipo
- 2.- Mangueras ultrasonidos con y sin conector a equipo
- 3.- Mangueras micromotores con y sin conector a equipo
- 4.- Accesorios mangueras
- 5.- Mangueras jeringas con y sin conector a equipo

## MANGUERAS rm - TKD

RUMAR



- Origen: Italia
- Fabricante: Tekne Dental (TKD)
- Silicona: máxima calidad: alta durabilidad y mantienen los colores más tiempo
- Cables y tubos internos de la más alta calidad para una mayor durabilidad
- Valvulería de acero para las mangueras con regulación de spray: mayor precisión y durabilidad

12 MESES DE GARANTÍA

*¡Los fabricantes de sillones y nosotros confiamos en ellos!*

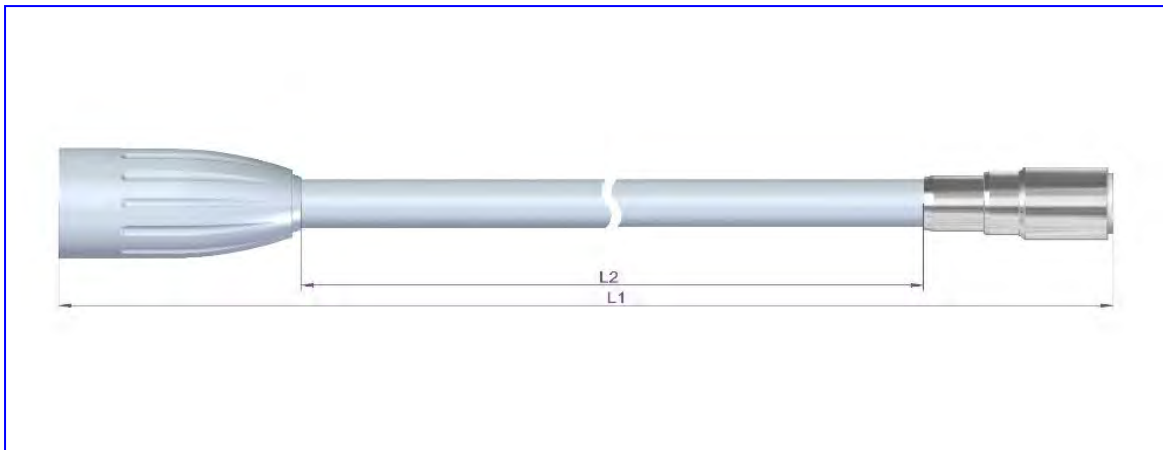

**L2: largo indicado en cada referencia en este catálogo.**

Información sobre tonos de gris:

GRIS CLARO= RAL 9002 (Tipo KaVo, Planmecca y similares)

GRIS = RAL 7035 (Tipo ADEC y similares)

GRIS OSCURO = RAL 7038 (Tipo Fedesa y similares) o RAL 7035+ (EEUU)

MANGUERAS PARA TURBINAS (OPEN END)		
40-31A2001 (rm-TKD)	Turbina Borden 3 – 3 orif, rizada, open end, sin luz, gris oscuro (RAL 7038)	€ 39,80
40-31A2000 (rm-TKD)	Turbina Borden 3 – 3 orif, open end, sin luz, 160cm, gris oscuro (RAL 7038)	€ 63,80
40-11B1000 (rm-TKD)	Turbina Midwest 4 c/luz – 6 orif, open end, 200cm, gris claro (RAL 9002)	€ 75,80
40-11A1000 (rm-TKD)	Turbina Midwest 4 c/luz – 6 orif, open end, 160cm, gris claro (RAL 9002)	€ 64,80
40-11A1001 (rm-TKD)	Turbina Midwest 4 c/luz – 6 orif, open end, <u>con regulación spray</u> , 160cm, gris claro (RAL 9002)	€ 139,80
40-11B2000 (rm-TKD)	Turbina Midwest 4 c/luz – 6 orif, open end, 200cm, gris oscuro (RAL 7038)	€ 75,80
40-11A2000 (rm-TKD)	Turbina Midwest 4 c/luz – 6 orif, open end, 160cm, gris oscuro (RAL 7038)	€ 64,80
40-11A2001 (rm-TKD)	Turbina Midwest 4 c/luz – 6 orif, open end, <u>con regulación spray</u> , 160cm, gris oscuro (RAL 7038)	€ 139,80
40-11A2002 (rm-TKD)	Turbina Midwest 4 c/luz – 6 orif, open end, 160cm x 10,33mm, diámetro, gris oscuro (RAL 7038) <u>(Especial equipos Vitali, OMS y comp.)</u>	€ 64,80
40-11B3000 (rm-TKD)	Turbina Midwest 4 c/luz – 6 orif, open end, 200cm, negro	€ 75,80
40-11B4000 (rm-TKD)	Turbina Midwest 4 c/luz – 6 orif, open end, 200cm, blanco	€ 75,80
40-21A2001 (rm-TKD)	Turbina Midwest 4 – 4 orif, rizada, open end, sin luz, gris oscuro (RAL 7038)	€ 39,80
40-21A1000 (rm-TKD)	Turbina Midwest 4 – 4 orif, open end, sin luz, 160cm, gris claro (RAL 9002)	€ 54,80
40-21A2000 (rm-TKD)	Turbina Midwest 4 – 4 orif, open end, sin luz, 160cm, gris oscuro (RAL 7038)	€ 54,80

40-21A2002 (rm-TKD)	Turbina Midwest 4 - 4 orif, open end, sin luz, <u>con regulación spray</u> , 160cm, gris oscuro (RAL 7038)	€ 119,80
40-21B1000 (rm-TKD)	Turbina Midwest 4 - 4 orif, open end, sin luz, 200cm, gris claro (RAL 9002)	€ 69,80
40-21B2000 (rm-TKD)	Turbina Midwest 4 - 4 orif, open end, sin luz, 200cm, gris oscuro (RAL 7038)	€ 69,80
40-21B3000 (rm-TKD)	Turbina Midwest 4 - 4 orif, open end, sin luz, 200cm, negro	€ 69,80
40-21B4000 (rm-TKD)	Turbina Midwest 4 - 4 orif, open end, sin luz, 200cm, blanco	€ 78,80
40-008* (EEUU)	Manguera 2 vías, rizada, open end, gris oscuro (RAL 7035 +) <b>* Hasta agotar existencias</b>	€ 25,80
40-007* (EEUU)	Manguera 4 vías, rizada sin terminal, gris oscuro (RAL 7035 +) <b>* Hasta agotar existencias</b>	€ 25,80

#### MANGUERAS PARA TURBINAS (CON CONECTOR A EQUIPO)

Para equipos Castellini, Anthos, Stern Weber (desde 2006):  
(Consultar otros colores)

40-12E2021 (rm-TKD)	Turbina Midwest 4 - 6 orif, c/luz, conector, con regulación spray, 135cm, gris oscuro (RAL 7038)	€ 296,80
40-12G2021 (rm-TKD)	Turbina Midwest 4 - 6 orif, c/luz, conector, con regulación spray, 120cm, gris oscuro (RAL 7038)	€ 299,80
40-12E2022 (rm-TKD)	Turbina Midwest 4 - 6 orif, c/luz, conector, 135cm, gris oscuro (RAL 7038)	€ 143,80
40-12G2022 (rm-TKD)	Turbina Midwest 4 - 6 orif, c/luz, conector, 120cm, gris oscuro (RAL 7038)	€ 138,80

Para equipos KaVo:  
(Consultar otros colores)

40-12G6010 (rm-TKD)	Turbina Midwest 4 – 6 orif, c/luz, conector <u>KaVo 1057, 1058*, 1060,1062, 1063, 1065, 1066, 1080, (Serie 1)</u> <u>(*Excepto 1058TM Primus Life)</u> , 120cm, gris medio (RAL 7035)	€ 156,80	
40-12E6010 (rm-TKD)	Turbina Midwest 4 – 6 orif, c/luz, conector <u>KaVo 1057, 1058*, 1060,1062, 1063, 1065, 1066, 1080, (Serie 1)</u> <u>(*Excepto 1058TM Primus Life)</u> , 135cm, gris medio (RAL 7035)	€ 159,80	
40-12G6011 (rm-TKD)	Turbina Midwest 4 – 6 orif, c/luz, <u>c/reg. Spray</u> , conector <u>KaVo 1057, 1058*, 1060,1062, 1063, 1065, 1066, 1080, (Serie 1) (*Excepto 1058TM Primus Life)</u> , 120cm, gris medio (RAL 7035)	€ 296,80→	
40-12E6011 (rm-TKD)	Turbina Midwest 4 – 6 orif, c/luz, <u>c/reg. Spray</u> , conector <u>KaVo 1057, 1058*, 1060,1062, 1063, 1065, 1066, 1080, (Serie 1) (*Excepto 1058TM Primus Life)</u> , 135cm, gris medio (RAL 7035)	€ 299,80→	
40-12G6012 (rm-TKD)	Turbina Midwest 4 – 6 orif, c/luz, conector <u>KaVo E30, E50TM, E70TN, E80TM y 1058 Primus Life (Serie 2)</u> , 120cm, gris medio (RAL 7035)	€ 168,00	
40-12E6012 (rm-TKD)	Turbina Midwest 4 – 6 orif, c/luz, conector <u>KaVo E30, E50TM, E70TN, E80TM y 1058 Primus Life (Serie 2)</u> , 135cm, gris medio (RAL 7035)	€ 178,00	
40-12G6013 (rm-TKD)	Turbina Midwest 4 – 6 orif, c/luz, <u>c/reg. Spray</u> conector <u>KaVo E30, E50TM, E70TN, E80TM y 1058 Primus Life (Serie 2)</u> , 120cm, gris medio (RAL 7035)	€ 312,80→	
40-12E6013 (rm-TKD)	Turbina Midwest 4 – 6 orif, c/luz, <u>c/reg. Spray</u> conector <u>KaVo E30, E50TM, E70TN, E80TM y 1058 Primus Life (Serie 2)</u> , 135cm, gris medio (RAL 7035)	€ 318,00→	

Para equipos Sirona:

(Consultar otros colores)

43-5911322* (UE "no" TKD)	Turbina Midwest 4 – 6 orif, conector Sirona C6 E3, con luz, 100cm, gris claro (RAL 9002), diámetro: 9mm <b>* Hasta agotar existencias</b>	€ 219,00
05-HO1061A (MK-dent)	Turbina Midwest 4 – 6 orif, c/luz, conector Sirona A1, A2, A4, A5, AC, C1, C1+, C2, C2+, M1, M196, M1+, Profeel, Spirit, S1, S2, Intego, 137cm, gris claro (RAL 9002)	€ 198,00
05-HO1062A (MK-dent)	Turbina Midwest 4 – 6 orif, c/luz, conector Sirona C3, C3+, C6, E3, Intego, 103cm, gris claro (RAL 9002)	€ 198,00
05-HO1063A (MK-dent)	Turbina Midwest 4 – 6 orif, c/luz, conector Sirona Profeel+, C8+, Intego, 137cm, gris claro (RAL 9002) <u>(con filtro aire retorno)</u>	€ 198,00

Para equipos Planmeca:

(Consultar otros colores)

05-HO1071B (MK-dent)	Turbina Midwest 4 – 6 orif, c/luz, conector Planmeca, 820 Ohm, 103cm, gris medio (RAL 7035) (Ref. Planmeca J2600265-11)	€ 184,80
05-HO1072B (MK-dent)	Turbina Midwest 4 – 6 orif, c/luz, conector Planmeca, 560 Ohm, 90cm, gris medio (RAL 7035) (Ref. Planmeca J2600203-8)	€ 184,80
05-HO1073B (MK-dent)	Turbina Midwest 4 – 6 orif, c/luz, conector Planmeca, 430 Ohm, 93cm, gris medio (RAL 7035)	€ 184,80

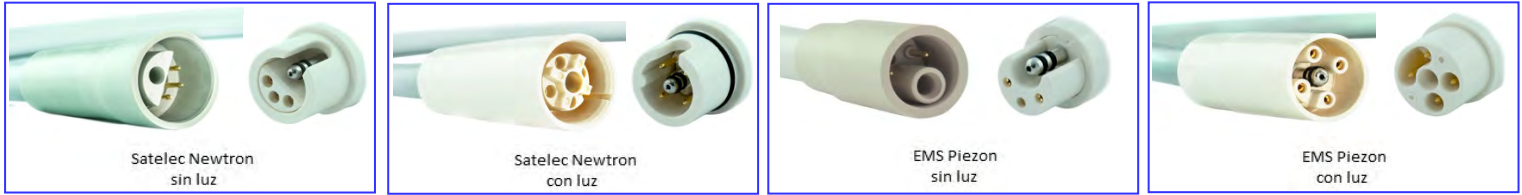

## ULTRASONIDOS

40-71B1100 (rm-TKD)	Para Satelec Newtron/Suprasson, sin luz, open end, 200cm x 9mm diámetro, gris claro (RAL 9002), (STANDARD)	€ 88,00
40-71B2100 (rm-TKD)	Para Satelec Newtron/Suprasson, sin luz, open end, 200cm x 9mm diámetro, gris oscuro (RAL 7038), (STANDARD)	€ 88,00
40-71B1110 (rm-TKD)	Para Satelec Newtron/Suprasson, sin luz, open end, 200cm x 7mm diámetro, gris claro (RAL 9002), (FINA)	€ 88,00
40-71B2110 (rm-TKD)	Para Satelec Newtron/Suprasson, sin luz, open end, 200cm x 7mm diámetro, gris oscuro (RAL 7038), (FINA)	€ 88,00
40-71B1111 (rm-TKD)	Para Satelec Newtron/Suprasson, sin luz, "doble conector Satelec Newtron", 200cm x 7mm diámetro, gris claro (RAL 9002), (FINA)	€ 161,80
40-71B1120 (rm-TKD)	Para Satelec Newtron/Suprasson, con luz, open end, 200cm x 7mm diámetro, gris claro (RAL 9002), (FINA)	€ 131,80
40-71B1130 (rm-TKD)	Para Satelec Newtron/Suprasson, con luz, open end, 200cm x 9mm diámetro, gris claro (RAL 9002), (STANDARD)	€ 131,80
40-71B1200 (rm-TKD)	Para EMS Piezon, sin luz, open end, 200cm x 9mm diám., gris claro (RAL 9002), (STANDARD)	€ 88,00
40-71B2200 (rm-TKD)	Para EMS Piezon, sin luz, open end, 200cm x 9mm diám., gris oscuro (RAL 7038), (STANDARD)	€ 88,00
40-71B1210 (rm-TKD)	Para EMS Piezon, sin luz, open end, 200cm x 7mm diám., gris claro (RAL 9002), (FINA)	€ 88,00
40-71B2210 (rm-TKD)	Para EMS Piezon, sin luz, open end, 200cm x 7mm diám., gris oscuro (RAL 7038), (FINA)	€ 88,00
40-71B1211 (rm-TKD)	Para EMS Piezon, sin luz, "doble conector EMS", 200cm x 7mm diámetro, gris claro (RAL 9002), (FINA)	€ 141,80



40-71B1220 (rm-TKD) Para EMS Piezon, con luz, open end, 200cm x 7mm diámetro, gris claro (RAL 9002), (FINA) € 121,80

40-71B1230 (rm-TKD) Para EMS Piezon, con luz, open end, 200cm x 9mm diámetro, gris claro (RAL 9002), (STANDARD) € 121,80

**EcoLine**

28-160 (Woodpecker) Para EMS Piezon, sin luz, open end, 200cm x 7mm diám., gris claro (RAL 9002) € 39,80

**EcoLine**

28-163 (Woodpecker) Para EMS Piezon, con luz, open end, 200cm x 7mm diám., gris claro (RAL 9002) € 50,80

**EcoLine**

28-161 (Woodpecker) Para Satelec Newtron, sin luz, open end, 200cm x 7mm diám., gris claro (RAL 9002) € 39,80

**EcoLine**

28-162 (Woodpecker) Para Satelec Newtron/Suprasson, con luz, open end, 200cm x 7mm diám., gris claro (RAL 9002) € 50,80



05-HO3031C (MK-dent) Standard para Mectron, sin luz, open end, 190cm 9mm diámetro, gris oscuro (RAL 7038) € 128,00

40-71A2400 (rm-TKD) Standard TKD (conexión TKD), sin luz, open end, 160cm, gris oscuro (RAL 7038) € 64,80





MANGUERAS PARA ULTRASONIDOS (CON CONECTOR A EQUIPO)  
(Consultar otros colores)

Para equipos KaVo:

40-72G6201 (rm-TKD)	Para ultrasonido EMS Piezon, sin luz, conector KaVo, 1058*, 1062, 1063, 1065 y 1080 (Serie 1) (*Excepto 1058TM Primus Life), 120cm x 9mm, (Standard), gris medio (RAL 7035)	€ 128,00→	
40-72E6201 (rm-TKD)	Para ultrasonido EMS Piezon, sin luz, conector KaVo 1058*, 1062, 1063, 1065 y 1080 (Serie 1) (*Excepto 1058TM Primus Life), 135cm x 9mm, (Standard), gris medio (RAL 7035)	€ 128,00→	
40-72G6202 (rm-TKD)	Para ultrasonido EMS Piezon, sin luz, <u>c/reg. spray</u> , conector KaVo 1058*, 1062, 1063, 1065 y 1080 (Serie 1) (*Excepto 1058TM Primus Life), 120cm x 9mm, (Standard), gris medio (RAL 7035)	€ 278,00→	
40-72E6202 (rm-TKD)	Para ultrasonido EMS Piezon, sin luz, <u>c/reg. spray</u> , conector KaVo 1058*, 1062, 1063, 1065 y 1080 (Serie 1) (*Excepto 1058TM Primus Life), 135cm x 9mm, (Standard), gris medio (RAL 7035)	€ 278,00→	
40-72G6200 (rm-TKD)	Para ultrasonido EMS Piezon, sin luz, conector KaVo E30, E50, E70, E80 y 1058 Primus Life (Serie2), 120cm x 9mm, (Standard), gris medio (RAL 7035)	€ 128,00	<i>En stock!</i>
40-72E6200 (rm-TKD)	Para ultrasonido EMS Piezon, sin luz, conector KaVo E30, E50, E70, E80 y 1058 Primus Life (Serie2), 135cm x 9mm, (Standard), gris medio (RAL 7035)	€ 128,00→	
40-72G6203 (rm-TKD)	Para ultrasonido EMS Piezon, sin luz, <u>c/reg. spray</u> , conector KaVo E30, E50, E70, E80 y 1058 Primus Life (Serie2), 120cm x 9mm, (Standard), gris medio (RAL 7035)	€ 288,00→	
40-72E6203 (rm-TKD)	Para ultrasonido EMS Piezon, sin luz, <u>c/reg. spray</u> , conector KaVo E30, E50, E70, E80 y 1058 Primus Life (Serie2), 135cm x 9mm, (Standard), gris medio (RAL 7035)	€ 288,00→	
40-72G6221 (rm-TKD)	Para ultrasonido EMS Piezon, con luz, conector KaVo 1058*, 1062, 1063, 1065 y 1080 (Serie 1) (*Excepto 1058TM Primus Life), 120cm x 9mm, (Standard), gris medio (RAL 7035)	€ 158,00→	
40-72E6221 (rm-TKD)	Para ultrasonido EMS Piezon, con luz, conector KaVo 1058*, 1062, 1063, 1065 y 1080 (Serie 1) (*Excepto 1058TM Primus Life), 135cm x 9mm, (Standard), gris medio (RAL 7035)	€ 158,00→	

40-72G6222 (rm-TKD)	Para ultrasonido EMS Piezon, con luz, <u>c/reg. spray</u> , conector KaVo 1058*, 1062, 1063, 1065 y 1080 (Serie 1) (*Excepto 1058TM Primus Life), 120cm x 9mm, (Standard), gris medio (RAL 7035)	€ 318,00→	
40-72E6222 (rm-TKD)	Para ultrasonido EMS Piezon, con luz, <u>c/reg. spray</u> , conector KaVo 1058*, 1062, 1063, 1065 y 1080 (Serie 1) (*Excepto 1058TM Primus Life), 135cm x 9mm, (Standard), gris medio (RAL 7035)	€ 318,00→	
40-72G6223 (rm-TKD)	Para ultrasonido EMS Piezon, con luz, conector KaVo E30, E50, E70, E80 y 1058 Primus Life (Serie2), 120cm x 9mm, (Standard), gris medio (RAL 7035)	€ 168,00→	
40-72E6223 (rm-TKD)	Para ultrasonido EMS Piezon, con luz, conector KaVo E30, E50, E70, E80 y 1058 Primus Life (Serie2), 135cm x 9mm, (Standard), gris medio (RAL 7035)	€ 168,00→	
40-72G6224 (rm-TKD)	Para ultrasonido EMS Piezon, con luz, <u>c/reg. spray</u> , conector KaVo E30, E50, E70, E80 y 1058 Primus Life (Serie2), 120cm x 9mm, (Standard), gris medio (RAL 7035)	€ 328,00→	
40-72E6224 (rm-TKD)	Para ultrasonido EMS Piezon, con luz, <u>c/reg. spray</u> , conector KaVo E30, E50, E70, E80 y 1058 Primus Life (Serie2), 135cm x 9mm, (Standard), gris medio (RAL 7035)	€ 328,00→	
40-72G6101 (rm-TKD)	Para ultrasonido Satelec Newtron/Suprasson, sin luz, conector KaVo 1058*, 1062, 1063, 1065 y 1080 (Serie 1) (*Excepto 1058TM Primus Life), 120cm x 9mm, (Standard), gris medio (RAL 7035)	€ 128,00→	
40-72E6101 (rm-TKD)	Para ultrasonido Satelec Newtron/Suprasson, sin luz, conector KaVo 1058*, 1062, 1063, 1065 y 1080 (Serie 1) (*Excepto 1058TM Primus Life), 135cm x 9mm, (Standard), gris medio (RAL 7035)	€ 128,00→	
40-72G6100 (rm-TKD)	Para ultrasonido Satelec Newtron/Suprasson, sin luz, conector KaVo E30, E50, E70, E80 y 1058 Primus Life (Serie2), 120cm x 9mm (Standard), gris medio (RAL 7035)	€ 128,00→	
40-72E6100 (rm-TKD)	Para ultrasonido Satelec Newtron/Suprasson, sin luz, conector KaVo E30, E50, E70, E80 y 1058 Primus Life (Serie2), 135cm x 9mm (Standard), gris medio (RAL 7035)	€ 128,00→	

40-72G6111 (rm-TKD)	Para ultrasonido Satelec Newtron/Suprasson, con luz, conector KaVo 1058*, 1062, 1063, 1065 y 1080 (Serie 1) (*Excepto 1058TM Primus Life), 120cm x 9mm, (Standard), gris medio (RAL 7035)	€ 178,00→	
40-72E6111 (rm-TKD)	Para ultrasonido Satelec Newtron/Suprasson, con luz, conector KaVo 1058*, 1062, 1063, 1065 y 1080 (Serie 1) (*Excepto 1058TM Primus Life), 135cm x 9mm, (Standard), gris medio (RAL 7035)	€ 178,00→	
40-72G6112 (rm-TKD)	Para ultrasonido Satelec Newtron/Suprasson, con luz, conector KaVo E30, E50, E70, E80 (Serie2), 120cm x 9mm (Standard), gris medio (RAL 7035)	€ 188,00→	
40-72E6112 (rm-TKD)	Para ultrasonido Satelec Newtron/Suprasson, con luz, conector KaVo E30, E50, E70, E80 (Serie2), 135cm x 9mm (Standard), gris medio (RAL 7035)	€ 188,00→	
Para equipos Castellini, Anthos, Stern Weber (desde 2006):			
40-72E2100 (rm-TKD)	Para ultrasonido Satelec Newtron/Suprasson, sin luz, conector Cefla, 135cm, gris oscuro (RAL 7038)	€ 108,00	
40-72G2100 (rm-TKD)	Para ultrasonido Satelec Newtron/Suprasson, sin luz, conector Cefla, 120cm, gris oscuro (RAL 7038)	€ 108,00	
40-72E2120 (rm-TKD)	Para ultrasonido Satelec Newtron/Suprasson LED, con luz, conector Cefla, 135cm, gris oscuro (RAL 7038)	€ 188,00→	
40-72G2120 (rm-TKD)	Para ultrasonido Satelec Newtron/Suprasson LED, con luz, conector Cefla, 120cm, gris oscuro (RAL 7038)	€ 198,00→	
40-72E2200 (rm-TKD)	Para ultrasonido EMS Piezon, sin luz, conector Cefla, 135cm, gris oscuro (RAL 7038)	€ 108,00	
40-72G2200 (rm-TKD)	Para ultrasonido EMS Piezon, sin luz, conector Cefla, 120cm, gris oscuro (RAL 7038)	€ 108,00	

40-72E2220 (rm-TKD)	Para ultrasonido EMS Piezon LED, con luz, conector Cefla, 135cm, gris oscuro (RAL 7038)	€ 178,00→	
40-72G2220 (rm-TKD)	Para ultrasonido EMS Piezon LED, con luz, conector Cefla, 120cm, gris oscuro (RAL 7038)	€ 168,00→	
40-72E2221 (rm-TKD)	Para ultrasonido EMS Piezon LED, con luz, <u>c/reg. spray</u> , conector Cefla, 135cm, gris oscuro (RAL 7038)	€ 348,00→	
40-72G2221 (rm-TKD)	Para ultrasonido EMS Piezon LED, con luz, <u>c/reg. spray</u> , conector Cefla, 120cm, gris oscuro (RAL 7038)	€ 343,80→	

Para equipos Planmeca:

05-HO4020A (MK-dent)	Para ultrasonido EMS Piezon, sin luz, conector Planmeca, 1300 Ohm, 93cm x <b>7mm</b> diámetro, gris claro (RAL 9002) (Ref. Planmeca J2900263-16)	€ 184,80	
05-HO4021A (MK-dent)	Para ultrasonido EMS Piezon, sin luz, conector Planmeca, 1300 Ohm, 93cm x <b>9mm</b> diámetro, gris claro (RAL 9002) (Ref. Planmeca J2900263-16)	€ 184,80	

MANGUERAS PARA MICROMOTORES (**OPEN END**)

(Consultar otros colores)

BIEN AIR (**open end**)

40-51A1006** (rm-TKD)	Micromotor MC2, Isolite/LED, ISO300 con luz, open end, 160cm, gris claro (RAL 9002) ** Adquiriendo casquillo Ref.: 40-010 se transforma en versión s/luz = "2 EN 1"	€ 98,00	
40-51A2006** (rm-TKD)	Micromotor MC2, Isolite/LED, ISO300 con luz, open end, 160cm, gris oscuro (RAL 7038) ** Adquiriendo casquillo Ref.: 40-010 se transforma en versión s/luz = "2 EN 1"	€ 98,00	
40-51A1001** (rm-TKD)	Micromotor MC2, Isolite/LED, ISO300 con luz, open end, 160cm, gris claro, (RAL 9002), <u>terminal giratorio 540°</u> ** Adquiriendo casquillo Ref.: 40-010 se transforma en versión s/luz = "2 EN 1"	€ 138,80	
40-51A2001** (rm-TKD)	Micromotor MC2, Isolite/LED, ISO300 con luz, open end, 160cm, gris oscuro, (RAL 7038), <u>terminal giratorio 540°</u> ** Adquiriendo casquillo Ref.: 40-010 se transforma en versión s/luz = "2 EN 1"	€ 138,80	
40-51A1002 (rm-TKD)	Micromotor MC2 IR, sin luz, open end, 160cm, gris claro (RAL 9002)	€ 93,80	
40-51A2002 (rm-TKD)	Micromotor MC2 IR, sin luz, open end, 160cm, gris oscuro (RAL 7038)	€ 93,80	

40-51A1003 (rm-TKD)	Micromotor MC3/LK/LED + turbina, <u>Polivalente</u> , open end, con y sin luz, Open End, 160cm, gris claro (RAL 9002)	€ 94,80
40-51A2003 (rm-TKD)	Micromotor MC3/LK/LED + turbina, <u>Polivalente</u> , con y sin luz, 160cm, gris oscuro (RAL 7038)	€ 94,80
40-51A2005 (rm-TKD)	Micromotor MC3/LK/LED con y sin luz, open end, 160cm, gris oscuro (RAL 7038)	€ 87,80
40-51A2004 (rm-TKD)	Micromotor MC3/LK/LED con y sin luz, open end, con regulación de spray, 160cm, gris oscuro (RAL 7038)	€ 198,00 → 
40-51A3003* (rm-TKD)	Micromotor MC3/LK/LED + turbina, <u>Polivalente</u> , con y sin luz, 160cm, negra (RAL 7038) <b>* Hasta agotar existencias</b>	€ 94,80
	<b>Chirana (open end)</b>	
40-51B1201 (rm-TKD)	Micromotor Chirana CH660, open end, 200cm, gris claro (RAL 9002)	€ 161,80
	<b>KaVo (open end)</b>	
40-51B1201 (rm-TKD)	Micromotor KaVo 190/196/197/200, open end, 200cm, gris claro (RAL 9002)	€ 161,80
05-HO2028A (MK-dent)	Micromotor KaVo K192 y K201, open end, 190cm, gris claro (RAL 9002)	€ 168,00
05-HO2028C (MK-dent)	Micromotor KaVo K192 y K201, open end, 190cm, gris oscuro (RAL 7038)	€ 168,00
05-HO2027B* (MK-dent)	Micromotor KaVo K700, KL700 Y KL701, open end, 190cm, gris medio (RAL 7035) <b>* Hasta agotar existencias</b>	€ 168,00
05-HO2027A (MK-dent)	Micromotor KaVo K700, KL700 Y KL701, open end, 190cm, gris claro (RAL 9002)	€ 168,00
40-51B1202 (rm-TKD)	Micromotor KaVo K700, KL700 Y KL701, open end, <u>c/reg. spray</u> , 200cm, gris claro (RAL 9002)	€ 281,80

MANGUERAS PARA MICROMOTORES (CON CONECTOR A EQUIPO)  
(Consultar otros colores)

Para equipos Castellini, Anthos, Stern Weber (desde 2006):

40-52E2002 (rm-TKD) Micromotor Bien Air MC2 IR, conector Cefla, 135cm, gris oscuro (RAL 7038) € 148,80

40-52G2002 (rm-TKD) Micromotor Bien Air MC2 IR, conector Cefla, 120cm, gris oscuro (RAL 7038) € 148,80

40-52E2006 (rm-TKD) Micromotor Bien Air MC2 Isolite/LED, conector Cefla, 135cm, gris oscuro (RAL 7038) € 174,80 → 

40-52G2006 (rm-TKD) Micromotor Bien Air MC2 Isolite/LED, conector Cefla, 120cm, gris oscuro (RAL 7038) € 174,80

40-52E2005 (rm-TKD) Micromotor Bien Air MC3/LK/LED, con y sin luz, conector Cefla, 135cm, gris oscuro (RAL 7038) € 164,80

40-52G2005 (rm-TKD) Micromotor Bien Air MC3/LK/LED, con y sin luz, conector Cefla, 120cm, gris oscuro (RAL 7038) € 166,80

40-52E2004 (rm-TKD) Micromotor Bien Air MC3/LK/LED, con y sin luz, conector Cefla, 135cm, gris oscuro, (RAL 7038), terminal giratorio € 184,80

40-52G2004 (rm-TKD) Micromotor Bien Air MC3/LK/LED, con y sin luz, conector Cefla, 120cm, gris oscuro, (RAL 7038), terminal giratorio € 186,80

40-52E2003 (rm-TKD) Micromotor Bien Air MC3/LK/LED + turbina, Polivalente, con y sin luz, 135cm, gris oscuro (RAL 7038) € 184,80 → 

40-52G2003 (rm-TKD) Micromotor Bien Air MC3/LK/LED + turbina, Polivalente, con y sin luz, 120cm, gris oscuro (RAL 7038) € 186,80

Para equipos KaVo





05-HO2034A (MK-dent) Micromotor KaVo K192 y K201, c/ reg. spray, con conector unidad 1057 y 1060, 135cm, gris claro (RAL 9002) € 228,00

05-HO2035A (MK-dent) Micromotor KaVo K192 y K201, c/ reg. spray, con conector unidad 1078, 135cm, gris claro (RAL 9002) € 228,00



40-52G6201 (rm-TKD) Micromotor KaVo K190, K196 y K200, c/ terminal giratorio, con conector unidad 1057 y 1060, 120cm, gris medio (RAL 7035) € 218,00

40-52E6201 (rm-TKD)	Micromotor KaVo K190, K196 y K200, <u>c/ terminal giratorio</u> , con conector unidad 1057 y 1060, 135cm, gris medio (RAL 7035)	€ 218,00	
40-52G6211 (rm-TKD)	Micromotor KaVo K190, K196 y K200, <u>c/ terminal giratorio</u> , <u>c/reg. spray</u> , conector unidad 1057 y 1060, 120cm, gris medio (RAL 7035)	€ 318,00	→ 
40-52E6211 (rm-TKD)	Micromotor KaVo K190, K196 y K200, <u>c/ terminal giratorio</u> , <u>c/reg. spray</u> , conector unidad 1057 y 1060, 135cm, gris medio (RAL 7035)	€ 324,80	→ 
40-52G6221 (rm-TKD)	Micromotor KaVo K190, K196 y K200, <u>c/ terminal giratorio</u> , conector KaVo 1058*, 1062, 1063, 1065 y 1080 (Serie 1) (*Excepto 1058TM Primus Life), 120cm, gris medio (RAL 7035)	€ 208,00	
40-52E6221 (rm-TKD)	Micromotor KaVo K190, K196 y K200, <u>c/ terminal giratorio</u> , conector KaVo 1058*, 1062, 1063, 1065 y 1080 (Serie 1) (*Excepto 1058TM Primus Life), 135cm, gris medio (RAL 7035)	€ 214,80	<i>En stock!</i>
40-52G6231 (rm-TKD)	Micromotor KaVo K190, K196 y K200, <u>c/ terminal giratorio</u> , <u>c/reg. spray</u> , conector KaVo 1058*, 1062, 1063, 1065 y 1080 (Serie 1) (*Excepto 1058TM Primus Life), 120cm, gris medio (RAL 7035)	€ 318,00	→ 
40-52E6231 (rm-TKD)	Micromotor KaVo K190, K196 y K200, <u>c/ terminal giratorio</u> , <u>c/reg. spray</u> , conector KaVo 1058*, 1062, 1063, 1065 y 1080 (Serie 1) (*Excepto 1058TM Primus Life), 135cm, gris medio (RAL 7035)	€ 324,80	→ 
40-52G6300 (rm-TKD)	Micromotor KaVo K700, KL700 y KL701, conector KaVo 1058*, 1062, 1063, 1065 y 1080 (Serie 1) (*Excepto 1058TM Primus Life), 120cm, gris medio (RAL 7035)	€ 211,80	→ 
40-52E6300 (rm-TKD)	Micromotor KaVo K700, KL700 y KL701, conector KaVo 1058*, 1062, 1063, 1065 y 1080 (Serie 1) (*Excepto 1058TM Primus Life), 135cm, gris medio (RAL 7035)	€ 216,80	
40-52G6301 (rm-TKD)	Micromotor KaVo K700, KL700 y KL701, <u>c/ reg. spray</u> , conector KaVo 1058*, 1062, 1063, 1065 y 1080 (Serie 1) (*Excepto 1058TM Primus Life), 120cm, gris medio (RAL 7035)	€ 375,80	→ 
40-52E6301 (rm-TKD)	Micromotor KaVo K700, KL700 y KL701, <u>c/ reg. spray</u> , conector KaVo 1058*, 1062, 1063, 1065 y 1080 (Serie 1) (*Excepto 1058TM Primus Life), 135cm, gris medio (RAL 7035)	€ 381,80	→ 







40-52G6310 (rm-TKD)	Micromotor KaVo K700, KL700 y KL701, conector KaVo E30, E50, E70, E80 y 1058 Primus Life (Serie 2), 120cm, gris medio (RAL 7035)	€ 222,80→	
40-52E6310 (rm-TKD)	Micromotor KaVo K700, KL700 y KL701, conector KaVo E30, E50, E70, E80 y 1058 Primus Life (Serie 2), 135cm, gris medio (RAL 7035)	€ 228,00→	
40-52G6311 (rm-TKD)	Micromotor KaVo K700, KL700 y KL701, <u>c/ reg. Spray</u> , conector KaVo E30, E50,E70, E80 y 1058 Primus Life (Serie 2), 120cm, gris medio (RAL 7035)	€ 386,80→	
40-52E6311 (rm-TKD)	Micromotor KaVo K700, KL700 y KL701, <u>c/ reg. Spray</u> , conector KaVo E30, E50,E70, E80 y 1058 Primus Life (Serie 2), 135cm, gris medio (RAL 7035)	€ 392,80→	

### Para equipos Sirona

05-HO3020A (MK-dent)	Micromotor Bien Air MC2 e Isolite 300, <u>c/ reg. spray</u> , conector unidad Sirona A1,A2, A4, A5, AC, C1, C1+, C2, C2+, C4, 137cm, gris claro (RAL 9002)	€ 288,00→	
05-HO3013B (MK-dent)	Micromotor Bien Air MC3, <u>c/ reg. spray</u> , conector unidad Sirona C8+, 137cm, gris claro (RAL 9002)	€ 288,00	
05-HO3015A (MK-dent)	Micromotor Bien Air MC3, <u>c/ reg. spray</u> , conector unidad Sirona A1, A2, A4, A5, AC, C1, C1+, C2, C2+, C4, 137cm, gris claro (RAL 9002)	€ 288,00	
05-HO3016A (MK-dent)	Micromotor Bien Air MC3 y NSK TI-MAX M40, con terminal rotatorio 400°, conector unidad Sirona M1, C6 y E3, M1+, M196, C3, C3+, 137cm, gris claro (RAL 9002)	€ 288,00	
05-HO3014B (MK-dent)	Micromotor NSK TI-MAX M40, conector unidad Sirona A1, A2, A4, A5, AC, C1, C1+, C2, C2+, C4, C4+, E1, E2, E4, E5, EC, M1, M1+, M196, Spirit S1, S2, 137cm, gris medio (RAL 7035)	€ 288,00→	

### Para equipos Planmeca

05-HO4012A (MK-dent)	Micromotor Bien Air MC3, con terminal rotatorio 400°, conector unidad Planmeca, 82 Ohm, 100cm, gris claro (RAL 9002) (Ref. Planmeca J10044908-1)	€ 288,00	
05-HO4013A (MK-dent)	Micromotor <u>Polivalente</u> Bien Air MC3 + Turbina, conector unidad Planmeca, 82 Ohm, 98cm, gris claro (RAL 9002) (Ref. Planmeca J10044909-1)	€ 288,00→	

05-HO4014A (MK-dent)	Micromotor <u>Polivalente</u> Bien Air MC3 + Turbina, conector unidad Planmeca, 82 Ohm, 90cm, gris claro (RAL 9002)	€ 288,00→	
05-HO4015A (MK-dent)	Micromotor KaVo K190, 196 y K200 y Chirana Medical CH660, c/luz, conector unidad Planmeca, 270 Ohm, <b>100cm</b> , gris claro (RAL 9002) (Ref. Planmeca J10007954-4)	€ 188,00	
05-HO4017A (MK-dent)	Micromotor KaVo K190, 196 y K200, c/luz, con terminal giratorio 400°, conector unidad Planmeca, 270 Ohm, <b>101cm</b> , gris claro (RAL 9002) (Ref. Planmeca J10007954-4)	€ 288,00→	
05-HO4018A (MK-dent)	Micromotor KaVo K190, 196 y K200, c/luz, con terminal giratorio 400°, conector unidad Planmeca, 270 Ohm, 101cm, gris claro (RAL 9002) (Especial Kart)	€ 288,00	
05-HO4019A (MK-dent)	Micromotor KaVo K190, 196 y K200, c/luz, con terminal giratorio 400°, conector unidad Planmeca, 270 Ohm, 100cm, gris claro (RAL 9002)	€ 288,00→	

**Para equipos Swident CONSULTAR**

**Para equipos OMS CONSULTAR**

ACCESORIOS Y CONECTORES MANGUERAS



40-010 (rm-TKD) Casquillo metálico adaptador para mangueras MC2 € 12,80



40-006 (rm-TKD) Casquillo metálico adaptador para convertir mangueras MC3 a turbina € 15,80

40-020 (rm-TKD) Kit conector manguera a unidades KaVo (Serie 1) € 53,80

## MANGUERAS PARA JERINGAS

40-61A2000 (rm-TKD)	Manguera para jeringa, sin luz, open end, 160cm, gris oscuro (RAL 7038)	€ 38,00
43-8123* (UE "no" TKD)	Manguera para jeringa con luz/calefacción, 150cm, gris claro (RAL 9002) <b>* Hasta agotar existencias</b>	€ 47,70
43-831131* (UE "no" TKD)	Manguera especial equipos KaVo, conector especial jeringas 6F KaVo / conector equipo, sin luz, 125cm, gris claro (RAL 9002) <b>* Hasta agotar existencias</b>	€ 278,00
43-831132* (UE "no" TKD)	Manguera especial equipos KaVo, conector especial jeringas 6F KaVo / conector equipo, sin luz, 140cm, gris claro (RAL 9002) <b>* Hasta agotar existencias</b>	€ 278,00

## MANGUERAS PARA LÁMPARAS FOTOCURADO

40-91A2000 (rm-TKD)	Lámpara TKD Moon, open end, 160cm, gris oscuro (RAL 7038) / Compatible lámpara Castellini T-LED	€ 52,80
------------------------	---	---------

## TUBOS DE MEDIOS PARA MANGUERAS (PEDIDO MÍNIMO: 10 M / MÚLTIPLOS DE 5 M) (NO ADMITEN DEVOLUCIÓN)

44-520	Tubo de medios d.i. 2,8mm, verde (aire o agua) ( <u>x metro</u> )	€ 2,10
44-521	Tubo de medios d.i. 2,8mm, amarillo (aire o agua) ( <u>x metro</u> )	€ 2,10
44-525	Tubo de medios d.i. 1,4mm, azul (aire o agua) ( <u>x metro</u> )	€ 2,10
44-526	Tubo de medios d.i. 1,4mm, amarillo (aire o agua) ( <u>x metro</u> )	€ 2,10

## MANGUERAS PARA PEDALES

37-241\* Pedales con control de agua, sin chip blower, € 50,80  
sin conectores, 180cm, 3 vías, gris claro (RAL 9002)  
(funda de silicona)

\* Hasta agotar existencias



44-850 Pedales con control de agua y chip blower, € 14,80  
sin conectores, 4 tubos paralelos, gris oscuro (RAL 7035+)  
"aséptico" (x metro)

# RUMAR

mayorista dental

## REPUESTOS VARIOS

- 1.- Repuestos Micron scaler SSS
- 2.- Repuestos pulidor bicarbonato Micron Quick Jet
- 3.- Repuestos lámparas quirófano Derungs
- 4.- Repuestos taburetes Pluto
- 5.- Repuestos equipo mural €coLine
- 6.- Repuestos Nouvag
- 7.- Repuestos taburetes Jörg & Sohn
- 8.- Repuestos Woodpecker y DTE
- 9.- Lámpara polimerizar para unidad
- 10.- Repuestos lámparas polimerizar
- 11.- Piezas de mano y kits built in ultrasonidos
- 12.- Kits built in micromotores eléctricos
- 13.- Micromotores eléctricos canje

## Ultrasonidos Micron SSS

SUPERSÓNICO SSS

**MICRON®**

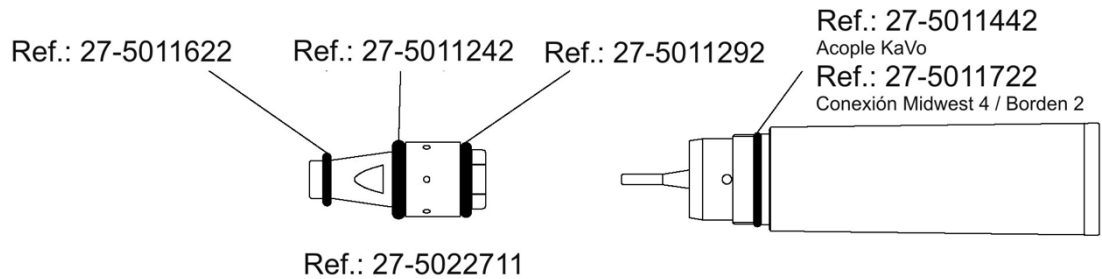

27-5022711	Cartucho cuerpo de oscilación	€ 348,00
27-5011622	Anillo tórico	€ 3,80
27-5011242	Anillo tórico	€ 3,80
27-5011292	Anillo tórico	€ 3,80
27-5011442	Anillo tórico (SSS acople KaVo)	€ 3,80
27-5011722	Anillo tórico (SSS conexión Midwest 4 / Borden 2)	€ 3,80

Las puntas y llaves se consideran accesorios y se encuentran en el catálogo de aparatología

## Pulidor bicarbonato ECO PULIMAX



44-231    Punta pulidor ECO PULIMAX    € 19,80



44-232    Kit 2 anillos tóricos conexión punta pulidor ECO PULIMAX    € 1,50



Pulidor bicarbonato MK-dent / Micron

**MICRON®**

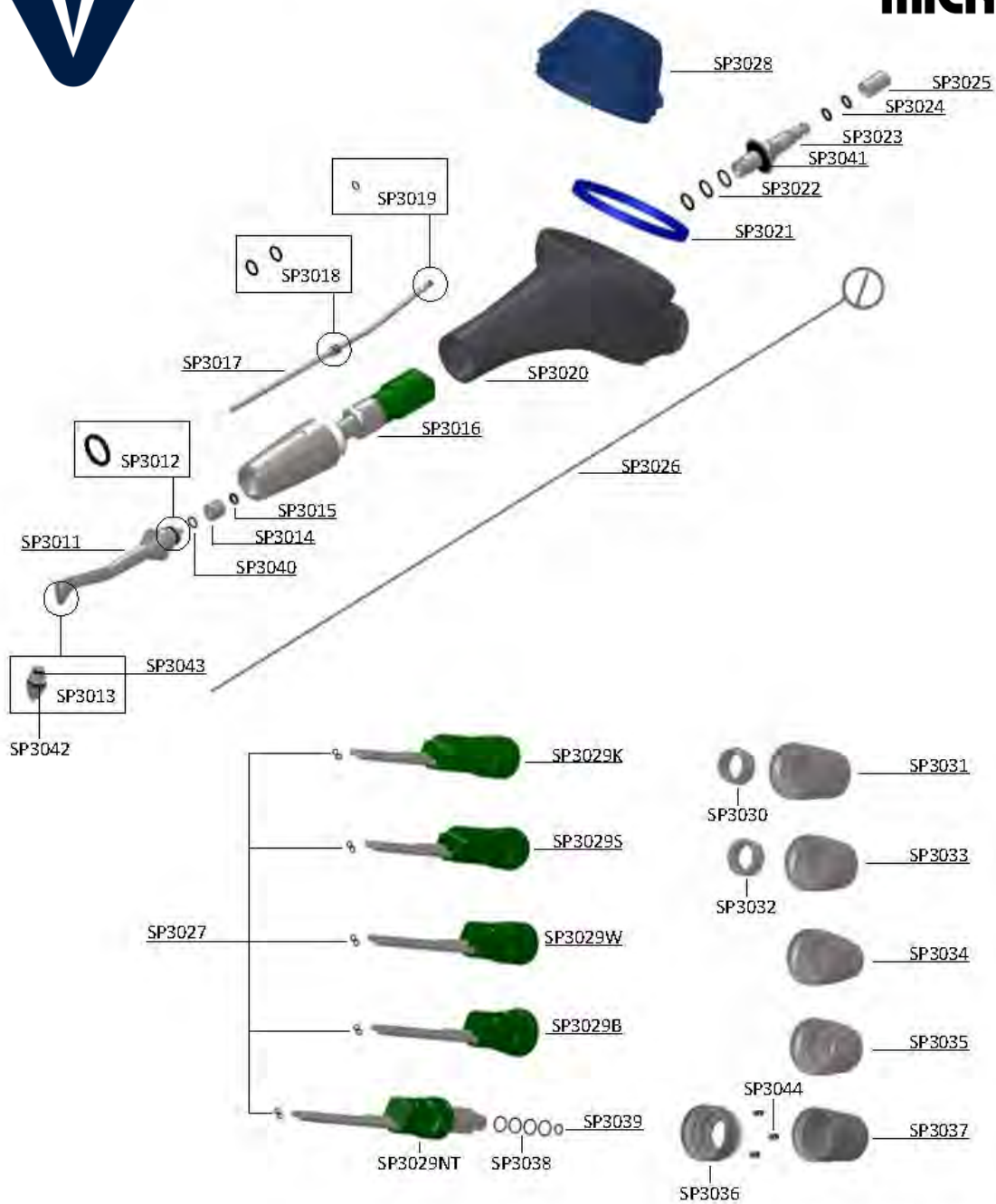

05-SP3012	Anillo tórico	€	2,80
05-SP3015	Anillo tórico	€	2,80
05-SP3018	Anillo tórico	€	2,80
05-SP3019	Anillo tórico	€	2,80
05-SP3021	Junta sellado depósito bicarbonato	€	6,80
05-SP3022	Anillo tórico	€	2,80
05-SP3024	Anillo tórico	€	2,80
05-SP3027	Anillo tórico	€	2,80
05-SP3040	Anillo tórico	€	2,80
05-SP3041	Anillo tórico	€	2,80
05-SP3042	Anillo tórico	€	2,80
05-SP3043	Anillo tórico	€	2,80
05-SP3026	Alambre de desatasco	€	6,40
05-SP3011	Punta	€	138,80

## Scaler ECO S2

44-ECOS2CV Cuerpo vibrador € 128,00  
(Para anillos tóricos consultar sección anillos tóricos)

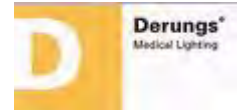

## Repuestos Lámparas de Quirófano Derungs

### MODELO XERUS

09-910*	Asa central D99205000	€ 69,30
09-916*	Pantalla D99278000	€ 141,60
09-918*	Interruptor D70114000	€ 29,60

### MODELO IRIS / ISIS 50

09-920*	Bombilla D68615000	€ 26,80
09-921*	Asa central D55234000	€ 98,30

## Repuestos Equipo Mural €coLine

44-191	Botella suministro agua equipo mural €coLine 2	€ 14,80
44-192	Conector hembra botella suministro agua equipo mural €coLine 2	€ 9,80



## Repuestos Nouvag



### IMPLANTOLOGÍA / CIRUGÍA

48-2064	Micromotor 31-ESS para MD20, c/cable 3 m	€ 980,00
48-2063	Micromotor 31-ESS para MD10, c/cable 2 m	€ 980,00
48-2097	Micromotor 21 para MD30 / MD11, c/cable 2m	€ 908,00
48-1770	Varilla soporte suero motores Nouvag MD10, MD11, MD20, MD30 y compatibles.	€ 28,00

**OTRAS REFERENCIAS PREGÚNTENOS**

## Repuestos Taburetes Jörg & Sohn



07-601*	Rueda para taburetes * Hasta agotar existencias	€ 17,60
---------	--	---------



## Repuestos Woodpecker y DTE



### Repuestos Ultrasonidos

28-28001	Válvula solenoide ultrasonidos Woodpecker y DTE D5, D7 y comp.	€	28,80
28-28002	Fusible ultrasonidos DTE D5, D7 y compatibles	€	12,80
28-28003	Tubo gris ultrasonidos DTE D5, D7 y compatibles	€	12,80
28-28004	Transformador DTE D5, D7 y compatibles	€	38,00
28-28005	Pedal DTE D5, D7 y compatibles	€	30,80
28-28006	Botella con tapa 500ml DTE D7, Woodpecker UDS-E y compatibles	€	13,80
28-28007	Conector espigas entrada ultrasonidos DTE D7 y comp.	€	11,80
28-28008	Conectores receptor hembra botella ultrasonidos DTE D7 y compatibles	€	10,80
28-28009	Potenciómetro regulación caudal ultrasonidos DTE D7 y compatibles	€	10,80
28-28025	Regulador caudal ultrasonidos DTE D5 y compatibles	€	13,80
28-28011	Soporte pieza de mano ultrasonidos DTE D7 y comp.	€	10,80
28-28012	Tuerca sujeción entrada agua ultrasonidos D5 y comp. (4x6mm)	€	2,80
28-28016	Anillo tórico conexión botella suministro agua DTE D7	€	0,90
28-28017	Placa electrónica central DTE D7	€	118,00
28-28018	Panel botonera DTE D7 y compatibles	€	50,80
28-288H	Manguera ultrasonidos DTE D600 LED, open end, 200cm x 7mm diámetro, gris claro, (RAL 9002)	€	50,80
28-28010	Potenciómetro regulación caudal ( <u>suministro autónomo</u> ) ultrasonidos DTE D600 y comp.	€	10,80
28-28026	Regulador caudal ( <u>suministro externo</u> ) ultrasonidos DTE D600 y comp.	€	13,80

28-28028	Tanque con tapa Ultrasonidos WOODPECKER D600 y D600 LED	€	18,80
28-28014	Válvula solenoide ultrasonidos Woodpecker y DTE D600 Y comp.	€	28,80
28-28015	Bomba de agua ultrasonidos Woodpecker y DTE D600	€	10,80
<b>NOVEDAD!!!</b>	28-28051 Manguera aeropilador AP-B	€	128,00
<b>NOVEDAD!!!</b>	28-28052 Manguera ultrasonidos AP-B	€	48,00
<b>NOVEDAD!!!</b>	28-28053 Válvula solenoide ultrasonidos AP-B	€	28,00
<b>NOVEDAD!!!</b>	28-28054 Cartucho válvula solenoide aeropilador AP-B	€	64,80
<b>NOVEDAD!!!</b>	28-28055 Placa electrónica central AP-B	€	548,00
<b>NOVEDAD!!!</b>	28-28056 Fuente alimentación AP-B	€	54,80
<b>NOVEDAD!!!</b>	28-28057 Tanque con tapa subgingival AP-B	€	64,80
<b>NOVEDAD!!!</b>	28-28058 Tanque con tapa supragingival AP-B	€	64,80
<b>NOVEDAD!!!</b>	28-28059 Botella 700ml AP-B	€	48,00
<b>NOVEDAD!!!</b>	28-28060 Conector rápido AP-B	€	28,00
<b>NOVEDAD!!!</b>	28-28061 Filtro AP-B	€	20,80
28-020	Potenciómetro kits built in V3, V3 LED, UDS-N3, UDS-N3 LED	€	15,80
28-156L	LED pieza de mano HW-5L	€	9,80
28-155L	LED pieza de mano HD-7L	€	9,80
28-184	Transformador AT-1	€	14,80
28-28013	Tubos grises paralelos AT-1	€	8,00

## Repuestos Motores Endodoncia

28-ENDO1BHP	Pieza de mano endo activador ultrasónico "Woodpecker" Endo 1, blanco (Rosca tipo EMS)	€ 108,00
28-ENDO1MHP	Pieza de mano endo activador ultrasónico "DTE" Endo 1, morado (Rosca tipo Satelec)	€ 108,00
28-318HP	Pieza de mano Motopex, Blanca (sin contra ángulo)	€ 498,00
28-301HP	Pieza de mano Endo Smart Plus (sin contra ángulo)	€ 280,00
28-311HP	Pieza de mano Endo Radar Plus, Blanca (sin contra ángulo)	€ 398,00
<b>NOVEDAD!!!</b>	28-328HPN Pieza de mano Smart-A, Naranja (sin contra ángulo)	€ 918,00
<b>NOVEDAD!!!</b>	28-328HPB Pieza de mano Smart-A, Blanca (sin contra ángulo)	€ 918,00
28-214	Batería Endo 1	€ 18,80
28-300CAH	Cabeza contra ángulo Endo Radar, Endo Smart y E-com	€ 180,00
28-311CAH	Cabeza contra ángulo Endo Radar "Plus", Endo Smart "Plus" y Motopex	€ 280,00
<b>NOVEDAD!!!</b>	28-328CAH Cabeza contra ángulo Smart-A	€ 348,00
28-310BAT	Batería Endo Radar, Endo Radar "Plus", Endo Smart, E-com, Endo Smart "Plus", Ai Motor y Motopex	€ 28,80
<b>NOVEDAD!!!</b>	28-328BBAT Batería base Smart-A	€ 28,00
<b>NOVEDAD!!!</b>	28-328HPBAT Batería pieza de mano Smart-A	€ 28,00
<b>NOVEDAD!!!</b>	28-328FPBAT Batería pedal Smart-A	€ 28,00
28-300T	Transformador Endo Smart, E-com y Endo Smart "Plus"	€ 20,80
28-311T	Transformador Endo Radar y Endo Radar "Plus"	€ 20,80
28-318T	Transformador Motopex	€ 28,00
<b>NOVEDAD!!!</b>	28-328T Transformador Smart-A	€ 36,80
	28-210 Gancho labial (pareja) Endo Radar, Endo Radar "Plus", y Motopex. Compatible con Morita Triauto	€ 10,80



28-211	Cable gancho labial Endo Radar, Endo Radar "Plus"	€ 18,80
28-212	Cable limas Endo Radar, Endo Radar "Plus"	€ 19,80
28-28022	Cable mini USB E-com +	€ 18,00
28-28023	Cable USB Endo Radar y Endo Radar "Plus"	€ 28,80
28-28027	Cable mini USB Motopex	€ 28,00
28-28024	Funda cabeza Endo Radar "Plus" y Motopex, 1 ud.	€ 4,80
28-318BAS	Base Motopex	€ 58,00
<b>NOVEDAD!!!</b> 28-328BASN	Base Smart-A, Naranja	€ 228,00
<b>NOVEDAD!!!</b> 28-328BASB	Base Smart-A, Blanca	€ 228,00
<b>NOVEDAD!!!</b> 28-328FPN	Pedal Smart-A, Naranja	€ 208,00
<b>NOVEDAD!!!</b> 28-328FPB	Pedal Smart-A, Blanca	€ 208,00
28-28021	Soporte LED E-com +	€ 8,00

### Repuestos Motores de Implantes

28-28029	Cable micromotor LED SPM-58L, 1,80m – Woodpecker Implanter LED y DTE Implant X LED	€ 58,00
28-28031	Placa electrónica – Woodpecker Implanter LED y DTE Implant X LED	€ 280,00
28-28032	Display – Woodpecker Implanter LED y DTE Implant X LED	€ 218,00
28-28033	Bomba – Woodpecker Implanter LED y DTE Implant X LED	€ 139,80
28-28034	Bombilla LED micromotor LED SPM-58L – Woodpecker Implanter LED y DTE Implant X LED	€ 18,00
28-28035	Cable electrico – Woodpecker Implanter LED y DTE Implant X LED	€ 49,80
28-28036	Pedal multifuncional c/cable 2,80m – Woodpecker Implanter LED y DTE Implant X LED	€ 84,80

Para repuestos contra ángulos Woodpecker  
consultar sección repuestos rotatorio

## Repuestos Localizador de Ápices

	28-210	Gancho labial (pareja), Woodpex I, Woodpex III, Woodpex V, DPEX I, DEPX III, Ai-Pex y compatible con Morita Triauto	€	10,80
	28-28044	Punta test pulpa Ai-Pex, 2uds.	€	12,80
	28-211	Cable gancho labial Woodpex I, Woodpex III, Woodpex V, DPEX I, DEPX III y Ai-Pex	€	18,80
	28-212	Cable limas Woodpex I, Woodpex III, Woodpex V, DPEX I y DEPX III	€	19,80
	28-28042	Cable gancho labial Ai-Pex	€	18,80
	28-184	Transformador Woodpex III, Woodpex V, y DPEX III	€	16,80
	28-204T	Transformador localizadores de ápice Minipex	€	16,80
	28-28041	Transformador localizadores de ápice Ai-Pex	€	40,80
	28-214	Batería Woodpex III, Woodpex V y DPEX III	€	19,80
	28-310BAT	Batería Ai-Pex	€	28,80
	28-215	Cable gancho labial Minipex	€	15,80

## Repuestos Sistema de Obturación

28-28040	Batería Sistema de Obturación Gutta-Percha Fi-G	€	58,00
28-FIPBAT	Batería Sistema de Obturación Gutta-Percha Fi-P y Fi-E	€	58,00
28-780T	Transformador Sistema de Obturación Gutta-Percha Fi-G, Fi-P y Fi-E	€	58,00
28-176	Martillo accionador Sistema de Obturación Gutta-Percha Fi-G	€	66,80
<b>NOVEDAD!!!</b> 28-28062	Cierre y junta martillo accionador	€	3,80
<b>NOVEDAD!!!</b> 28-179	Anillo limpiador Sistema de Obturación Gutta-Percha Fi-E	€	5,80
28-FIGB	Base de carga Sistema de Obturación Gutta-Percha Fi-G	€	58,00
28-FIPB	Base de carga Sistema de Obturación Gutta-Percha Fi-P	€	58,00
<b>NOVEDAD!!!</b> 28-FIEB	Base de carga Sistema de Obturación Gutta-Percha Fi-E	€	48,00

## Repuestos Imágen Radiografía Oral Digital

<b>NOVEDAD!!!</b> 28-379T	Transformador i-Scan	€	49,80
---------------------------	----------------------	---	-------



#### LED.G

##### LÁMPARA DE POLIMERIZACIÓN BUILT IN

- Para integrar en equipos dentales
- Intensidad 1.000 – 1.200 mw/cm<sup>2</sup>.
- Longitud de onda 430 – 485 nm.
- 3 funciones, polimerización: Rápida, Intermitente y función Rampa.
- Guía esterilizable en autoclave hasta 135° C.
- Peso: sólo 135 gr.
- AC24V 50Hz / 60Hz

VÉANSE LÁMPARAS POLIMERIZACIÓN INALÁMBRICAS  
EN NUESTRA LISTA DE APARATOLOGÍA Y CIRUGÍA  
REFS.: 28-025, 28-170 Y 29-050



## REPUESTOS LÁMPARAS POLIMERIZACIÓN Guías de luz / Fibra Óptica Lámparas Polimerizar



28-031 Guía de luz / Fibra óptica Woodpecker LED.G, LED.C, LED.D, LED.F, LED.P, LED.B € 18,80

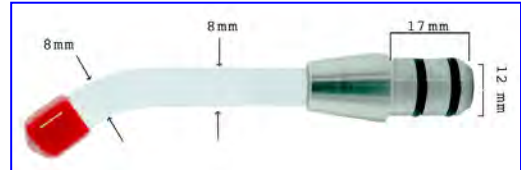

28-032 Guía de luz / Fibra óptica ECO LED1, Woodpecker LED.H LED.H ORTHO y BA OPTIMA10 € 18,80

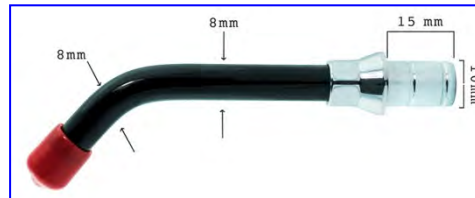

44-225 Guía de luz / Fibra óptica 8mm diám. / conector: 10mm diám. € 18,80

28-181MAX Punta DTE iLED MAX (metálica y mayor campo fotocurado) € 45,80

28-187M1\* Tapa transparente punta metálica DTE iLED PLUS (modelo antiguo), 1ud. \* Hasta agotar existencias € 0,90

28-187M2\* Tapa transparente punta metálica DTE iLED PLUS (modelo nuevo) y B-Cure Plus, 1ud. \* Hasta agotar existencias € 0,90

28-800FO Punta DTE B-Cure Plus metálica € 64,80

28-187M3 Tapa transparente punta DTE iLED MAX € 16,80

28-801\* Guía de luz / Fibra óptica DTE B-Cure (modelo antiguo) \* Hasta agotar existencias € 36,80

28-173FO Guía de luz / Fibra óptica Woodpecker LUX VI € 18,80

28-198FO1 Guía de luz / Fibra óptica Woodpecker X-cure standard € 44,80

28-198FO2 Guía de luz / Fibra óptica Woodpecker X-cure biselada € 44,80

28-808P Punta Woodpecker O-Star € 108,00

28-28045 Lente de cura de puntos lámpara Woodpecker O-Star, iLed MAX € 19,80



28-034\* Guía de luz / Fibra óptica para blanqueamiento (lámparas Woodpecker, DTE y compatibles; excepto iLED) € 29,80  
\* Hasta agotar existencias

40-53001 Guía de luz / Fibra óptica TKD Moon Ø8mm € 108,00

40-53002 Guía de luz / Fibra óptica TKD Moon Ø5mm € 118,00

### Baterías lámparas de polimerizar

28-172 Batería ECO LED1, Woodpecker LED.H y LED.H ORTHO € 19,80

28-214 Batería Woodpecker LUX VI € 19,80

28-183 Batería lámpara DTE iLED "todos los modelos" y Woodpecker LED.D y X-Cure € 19,80

28-194 Batería lámpara Woodpecker LED.C € 19,80

28-800BAT Batería lámpara DTE B-Cure € 34,80

28-28040 Batería lámpara O-Star € 58,00

### Protectores vista

28-033 Protector para vista LED.L, LED.G, LED.H, LED.H ORTHO, LED.C, LED.B, B-Cure y comp. € 5,80

28-173PUV Protector para vista LUX VI € 8,00

28-041 Protector para vista iLED "todos los modelos" € 8,00

28-800PUV Protector para vista B-Cure Plus € 12,80

28-808PUV Protector para vista O-Star € 5,80

Bases lámparas polimerizar		
28-171	Base ECO LED1 y Woodpecker LED.H	€ 28,00
28-186	Base lámpara DTE iLED blanca "todos los modelos"	€ 28,00
28-189	Base lámpara DTE iLED morada "todos los modelos"	€ 28,00
28-191	Base lámpara Woodpecker LED.D	€ 18,80
28-193	Base lámpara Woodpecker LED.C	€ 18,80
28-197BAS	Base lámpara Woodpecker X-Cure "Golden"	€ 83,80
28-198BAS	Base lámpara Woodpecker X-Cure "Silver"	€ 83,80
28-800BAS	Base lámpara DTE B-Cure	€ 28,00
28-808BAS	Base lámpara Woodpecker O-Star	€ 64,80

Transformadores lámparas polimerizar		
28-184	Transformador Woodpecker LED.H, DTE iLED, LED.C, LED.D, B-Cure, O-Star y comp.	€ 16,80
28-173T	Transformador lámpara Woodpecker LUX VI	€ 16,80
28-198T	Transformador lámpara Woodpecker X-Cure	€ 19,80

### MANGUERAS PARA LÁMPARAS FOTOCURADO

40-91A2000 (rm-TKD)	Lámpara TKD Moon, open end, 160cm, gris oscuro (RAL 7038) / Compatible lámpara Castellini T-LED	€ 52,80
---------------------	---	---------



42-480

### FUENTES DE ALIMENTACIÓN

RUMAR

Fuente de alimentación de luz para dotar de luz a equipos sin ella.  
Actuación neumática.  
Regulador de retardo apagado luz por manguera.  
Tensión alimentación: 12 – 30 V.  
Tensión salida: 2,5 – 3,5 V.

€ 96,80



44-650

Soporte instrumento polivalente

€ 9,80

## ULTRASONIDOS "BUILT IN"

### VER LISTA APARATOLOGÍA Y CIRUGÍA:

COMPATIBLE SATELEC: GARANTÍA: 2 AÑOS  
Ref.: 40-46093 Titanus S (s/luz)



COMPATIBLE EMS: GARANTÍA: 2 AÑOS  
Ref.: 40-41093 Titanus E (s/luz)

COMPATIBLE SATELEC:  
Ref.: 28-V3E DTE-V3 ENDO (s/luz)  
Ref.: 28-V3ELED DTE-V3 LED (c/luz)



COMPATIBLE EMS:  
Ref.: 28-U3E UDS-N3 ENDO (s/luz)  
Ref.: 28-U3ELED UDS-N3 LED ENDO (c/luz)



## PIEZAS DE MANO PARA ULTRASONIDOS

### VER LISTA APARATOLOGÍA Y CIRUGÍA:

COMPATIBLE SATELEC: GARANTÍA: 2 AÑOS  
Ref.: 40-46001 Titanus S (s/luz)



COMPATIBLE EMS: GARANTÍA: 2 AÑOS  
Ref.: 40-41001 Titanus E (s/luz)

COMPATIBLE SATELEC: GARANTÍA: 1 AÑO  
Ref.: 06-SC21S (s/luz)  
Ref.: 06-SC21SL (c/luz)



COMPATIBLE EMS: GARANTÍA: 1 AÑO  
Ref.: 06-SC21E (s/luz)  
Ref.: 06-SC21EL (c/luz)



COMPATIBLE SATELEC: GARANTÍA: 1 AÑO  
Ref.: 28-151 HD-7H (s/luz)  
Ref.: 28-155 HD-7L (c/luz)



COMPATIBLE EMS: GARANTÍA: 1 AÑO  
Ref.: 28-150 HW-3H (s/luz)  
Ref.: 28-152 HW-6 (s/luz)  
Ref.: 28-156 HW-5L (c/luz)







## MICROMOTORES ELÉCTRICOS



### MICROMOTORES "BUILT IN"

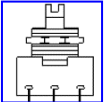

Fuente alimentación BMC40:  
-32V DC/CC +/-10%; 6A (10 seg.)  
- Dimensiones: 95x58mm.

- |   |   |                        |
|---|---|------------------------|
| 40-60093  | Kit built-in micromotor DEFINITIVE sin luz (SIN escobillas)<br>- Micromotor DEFINITIVE sin luz.<br>- Torque máximo: 3,5 Ncm.<br>- Peso: 90gr.<br>- Manguera silicona 8 orificios.<br>- Fuente de alimentación BMC40.<br>- <u>Garantía: 2 años.</u>                    | VER LISTA APARATOLOGÍA |
| 40-60293  | Kit built-in micromotor DEFINITIVE LED (SIN escobillas)<br>- Micromotor DEFINITIVE LED.<br>- Torque máximo: 3,5 Ncm.<br>- Peso: 90gr.<br>- Manguera silicona 8 orificios, <u>terminal giratorio.</u><br>- Fuente de alimentación BMC40.<br>- <u>Garantía: 2 años.</u> | VER LISTA APARATOLOGÍA |
|   | 40-39400      Convertidor CONV24 de 24V AC/CA a 32V DC/CC<br>- 24V AC/CA +/- 10%; 8A.<br>- Dimensiones: 60x50mm.<br>- <u>Garantía: 2 años.</u>  | VER LISTA APARATOLOGÍA |
|   | 40-39500      Potenciómetro neumático PPOT  | VER LISTA APARATOLOGÍA |
|  | 40-03520      Potenciómetro eléctrico (4.700 ohm)   |                        |
| 40-39600  | Selector MOT2 2 micromotores DEFINITIVE / DEFINITIVE LED  | VER LISTA APARATOLOGÍA |
|   | 40-39200      Panel de control DUOPAD<br>- 13V DC/CC +/- 20%; 22mA.<br>- Dimensiones: 73x117x24mm.<br>- Puede controlar 2 micromotores DEFINITIVE/LED y 1 ultrasonidos TITANUS.<br>- <u>Garantía: 2 años.</u>   | VER LISTA APARATOLOGÍA |

## MICROMOTORES ELÉCTRICOS RECICLADOS

Motores reciclados. En todos los casos se sustituye:  
Inducido, escobillas, rodamientos, anillos tóricos y  
la bombilla (en motores con luz).

Se retoca pero no se sustituye generalmente la carcasa  
del motor, que puede mostrar señales de uso.

Garantía: 6 meses

KAVO



Ref.: 90-002\*

K-191 sin luz

\* Hasta agotar existencias

VER LISTA APARATOLOGÍA

VER LISTA APARATOLOGÍA Y CIRUGÍA EN LA SECCIÓN DE MICROMOTORES



# REPUESTOS COMPRESORES DÜRR DENTAL

## REPUESTOS COMPRESORES Y SECADORES DÜRR

### COMPRESORES 51/52: PRIMO, DUO, TRIO Y CUATRO

68-11101	Kit reparación compresor 51/52 (PRIMO, DUO, TRIO y CUATRO) (Ref. Dürr 5110.992.00: 5150.981.00 kit juntas culata, 5110.105.50 culata)	€ 228,00
68-11102	Filtro compresor 51/52 (PRIMO, DUO, TRIO y CUATRO) (Ref. Dürr 0832.982.00)	€ 53,80

### COMPRESORES TORNADO 70/130

68-13101	Filtro redondo compresor Tornado 70/130 (Ref. Dürr 5430.982.00)	€ 34,80
68-13102	Kit reparación compresor Tornado 70/130 (Ref. Dürr 5430.981.00: cilindro, aro compresión, tornillo pistón y 2 juntas culata)	€ 228,00
68-13103	Porta filtro redondo compresor Tornado 70/130 (Ref. Dürr 0852.001.00)	€ 63,80
68-13104	Biela+pistón compresor Tornado 70/130 (Ref. Dürr 5430.984.00)	€ 528,00

### COMPRESORES TORNADO T1 Y T2

68-15101	Juego filtros compresor Tornado T1 y T2 (Ref. Dürr 5180.980.60: 1610.121.00 filtro anual superior, 1650.101.00 filtro secador membrana 1650 / sinterizado, 5180.982.00 filtro admisión)	€ 134,80
68-15104	Filtro admisión compresor DÜRR Tornado T1 y T2 (Ref. Dürr 5180.982.00)	€ 50,80
68-15102	Kit reparación juntas cilindro compresor Tornado T1 y T2 (Ref. Dürr 5180.981.00: junta interior, aro compresión pistón, tornillo sujeción aro de compresión)	€ 66,80
68-15103	Presostato compresor Tornado T1 y T2 (Ref. Dürr 5180.011.00E)	€ 186,80



SECADORES DÜRR

68-18101	Filtro secador todos los modelos (Ref. Dürr 1610.121.00)	€ 64,80
68-18103	Filtro secador membrana 1650 / sinterizado + colector + anillo tórico (Ref. Dürr 1650.101.00)	€ 47,80
68-18104	Filtro HEPA secador todos los modelos (Ref. Dürr 1650100172) (Antigua 1640.981.00)	€ 228,00



## SISTEMAS DE ASPIRACIÓN Y REPUESTOS

- 1.- Motores aspiración Luzzani Dental y repuestos
- 2.- Motores aspiración, centrifugadoras y separadores de amalgama METASYS
- 3.- Válvulas y accesorios METASYS
- 4.- Repuestos aspiraciones METASYS
- 5.- Conectores META connect (METASYS)
- 6.- Motores aspiración, centrifugadoras y separadores de amalgama Dürr Dental
- 6.- Repuestos aspiraciones Dürr Dental
- 8.- Conectores Dürr connect
- 9.- Soportes aspiración Luzzani Dental
- 10.- Mangueras y tubos aspiración
- 11.- Terminales de aspiración y adaptadores

# MOTORES DE ASPIRACIÓN SECA

## MOTORES LUZZANI



### MOTORE ASINCRONO MONOFASE

Tensione alimentazione	V.220* 50Hz
Potenza assorbita	Wa 415
Assorbimento	A 1,86
Condensatore	$\mu$ F 10
Cos $\varphi$	0,96
Giri	2810 RPM
Servizio	Continuo
Depressione statica	1.300 mm d'acqua
Portata aria aspirata	1.200 litri/minuti

\* A richiesta è fornito con diverse tensioni

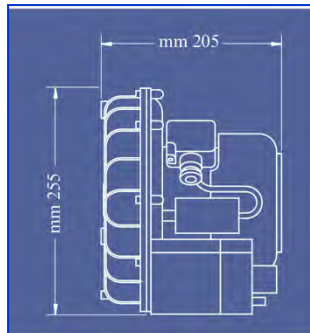

### DIAGRAMMA DEPRESSIONE

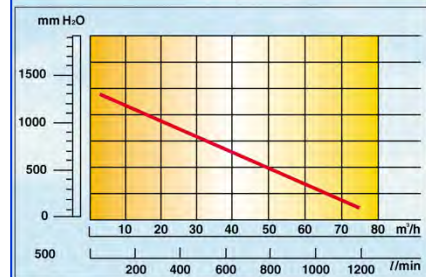

- Máxima fiabilidad + Máximo silencio.
- Puede funcionar de forma continuada.
- Depresión estática: 1.300 mm de agua aprox.
- Caudal de aire: 1.200 l/min.
- Funcionamiento: aspiración y compresión.
- Ausencia completa de ruido.
- Garantía: 1 año.

Ref.: 39-8AIRMAT

€ 418,00

CONSÚLTENOS POR SUS REPUESTOS

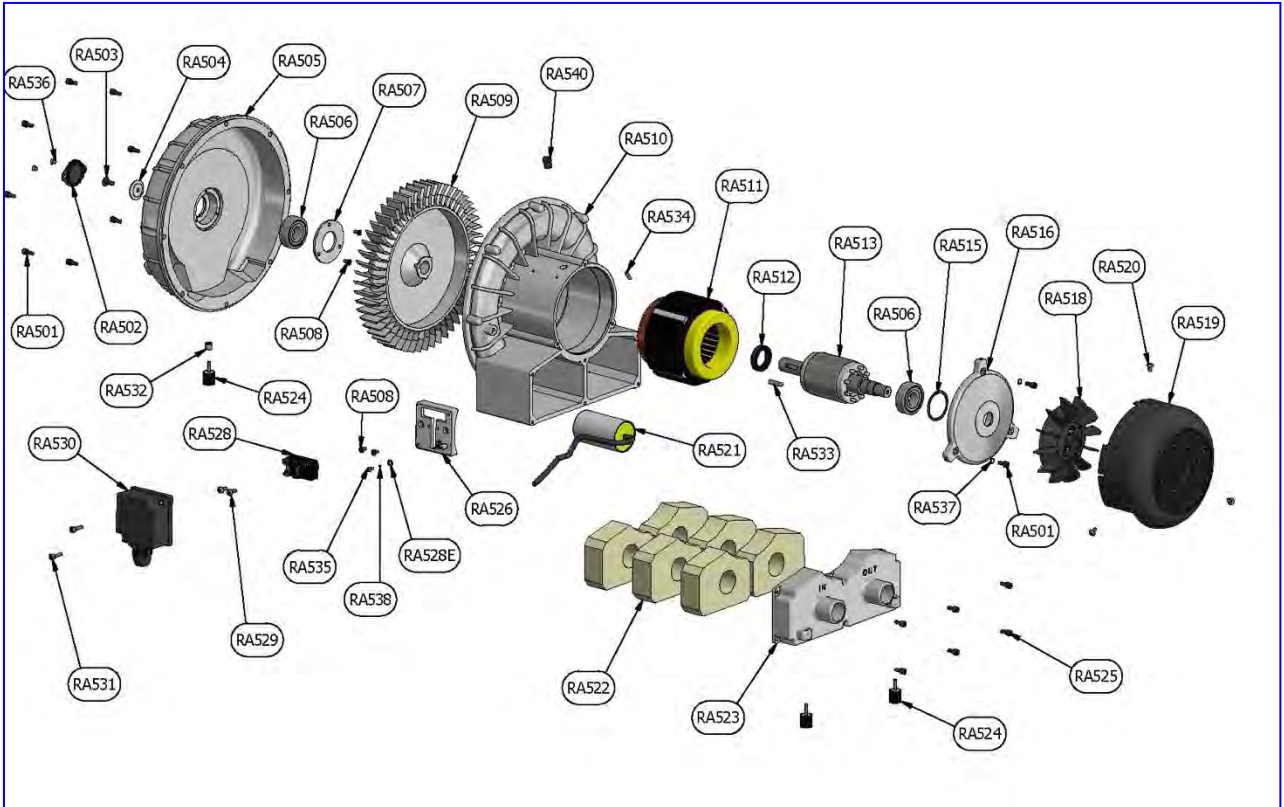

### REPUESTOS MOTOR LUZZANI AIRMATIC

39-8R506	Rodamiento (R506)	€ 15,80
39-8R522	Silenciadores (R522)	€ 15,80





### Rotor separador centrífugo

Módulo separador que, gracias a su fuerza centrífuga, garantiza una separación continua y perfecta incluso con grandes cargas de espuma. Para que la bomba de vaciado funcione de por vida, la fiabilidad de la separación debe estar garantizada.

### Regulación de presión negativa controlada por frecuencia\*

Según los requisitos de potencia, la regulación de la presión negativa se realiza mediante un control de frecuencia que proporciona a las cánulas una gran presión negativa constante de 180 mbar. Además, la función controlada por frecuencia reduce considerablemente el consumo energético.

\*solo para EXCOM hybrid 5

### Rueda de turbina de aluminio

La rueda de turbina de aluminio de marcha libre garantiza la seguridad del funcionamiento a largo plazo. No se utilizan ruedas de plástico.

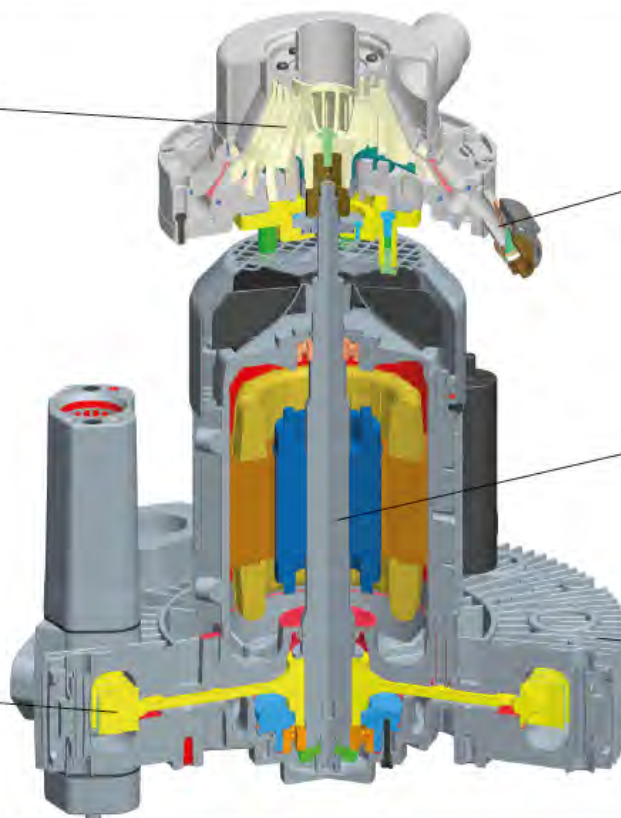

### Desagüe más alto de las aguas residuales

Un desagüe de aguas residuales colocado más alto permite una conexión cómoda con el desagüe o el separador de amalgama. Con ello ya no se requiere ninguna otra instalación para una posible elevación necesaria del aparato de aspiración.

### Un eje de motor

Un eje de motor para mover tanto el generador de presión negativa como la separación, al mismo tiempo que permite el funcionamiento simultáneo de ambos módulos. Esto impide el peligro de un posible derrame de líquido provocado por una separación que no esté funcionando dentro de una bomba de vacío en marcha.

### Aletas de refrigeración que optimizan el caudal de aire

El diseño especial de estas aletas optimizadas garantiza una mejor refrigeración y una mayor protección contra el sobrecalentamiento. El caudal de aire y refrigeración eficiente que proporcionan estas aletas de refrigeración permite un rápido descenso del calor.

## MOTORES METASYS ASPIRACIÓN HÍBRIDA (HÚMEDA Y SECA) CENTRALIZADOS SIN SEPARACIÓN AMALGAMA

EXCOM Hybrid 1S



EXCOM Hybrid 1



EXCOM Hybrid 2



EXCOM Hybrid 5



	EXCOM Hybrid 1s	EXCOM Hybrid 1	EXCOM Hybrid 2	EXCOM Hybrid 5
Tensión de alimentación	230 V AC	230 V AC	230 V AC	230 V AC / 400 V AC
Frecuencia	50 / 60 Hz	50 / 60 Hz	50 / 60 Hz	50 / 60 Hz
Consumo máx. corriente	3,5 / 4,5 A	6,7 A	6,7 A	9,0 / 10,0 A // 4,3 / 4,4 A
Consumo máx. potencia	0,55 / 0,63 kW	0,94 / 1,1 kW	1,1 / 1,3 kW	1,5 / 1,75 kW
Temperatura máx. ambiente	40° C	40° C	40° C	40° C
Volumen aspiración	1.100 l/min	1.100 / 1.300 l/min	1.450 / 1.750 l/min	2.000 / 2.400 l/min
Zona presión negativa regulada	120 / 140 mbar	180 mbar	180 mbar	180 mbar
Nivel sonoro	63 dB (A)	57 / 62 dB (A)	58 / 63 dB (A)	64 / 68 dB (A)
Dimensiones (Al x An x P) en mm	530 x 350 x 320	570 x 422 x 400	580 x 450 x 400	620 x 460 x 455
Peso	15 kg	22 kg	27 kg	30 kg
Duración conexión	100%	100%	100%	100%
Tasa separación	-	-	-	-
Número de equipos	<b>1 equipo</b>	<b>hasta 2 equipos</b>	<b>hasta 3 equipos</b>	<b>hasta 5 equipos</b>
Suministro incluye	Kit básico instalación (excepto tubo desahogo)	Kit básico instalación	Kit básico instalación	Kit básico instalación
Garantía	24 meses*	36 meses*	36 meses*	36 meses*

\* Mínimo de mantenimiento requerido

Ref.: 98-010154 EXCOM Hybrid 1s, con unidad de control € 1.280,00

Ref.: 98-010311 EXCOM Hybrid 1, con unidad de control € 1.738,00

Ref.: 98-010312 EXCOM Hybrid 2, con unidad de control € 2.378,00

Ref.: 98-010313 EXCOM Hybrid 5 (230 V), con unidad de control € 3.098,00 → 

Ref.: 98-010314 EXCOM Hybrid 5 (400 V), con unidad de control € 3.198,00 → 

## MOTORES METASYS ASPIRACIÓN HÍBRIDA (HÚMEDA Y SECA) CENTRALIZADOS CON SEPARACIÓN AMALGAMA

EXCOM Hybrid A1



EXCOM Hybrid A2



EXCOM Hybrid A5





	EXCOM Hybrid A1	EXCOM Hybrid A2	EXCOM Hybrid A5
Tensión de alimentación	230 V AC	230 V AC	230 V AC / 400 V AC
Frecuencia	50 / 60 Hz	50 / 60 Hz	50 / 60 Hz
Consumo máx. corriente	6,7 A	6,7 A	9,0 / 10,0 A // 4,3 / 4,4 A
Consumo máx. potencia	0,94 / 1,1 kW	1,1 / 1,3 kW	1,5 / 1,75 kW
Temperatura máx. ambiente	40º C	40º C	40º C
Volumen aspiración	1.100 / 1.300 l/min	1.450 / 1.750 l/min	2.000 / 2.400 l/min
Zona presión negativa regulada	180 mbar	180 mbar	180 mbar
Nivel sonoro	57 / 62 dB (A)	58 / 63 dB (A)	64 / 68 dB (A)
Dimensiones (Al x An x P) en mm	570 x 422 x 400	580 x 450 x 400	620 x 460 x 455
Peso	24,5 kg	29,5 kg	35 kg
Duración conexión	100%	100%	100%
Tasa separación	99,30%	99,30%	99,30%
Número de equipos	<b>hasta 2 equipos</b>	<b>hasta 3 equipos</b>	<b>hasta 5 equipos</b>
Suministro incluye	Kit básico instalación	Kit básico instalación	Kit básico instalación
Garantía	36 meses*	36 meses*	36 meses*

\* *Mínimo de mantenimiento requerido*

Ref.: 98-010251 EXCOM Hybrid A1-ECO II, con unidad de control € 2.458,00

Ref.: 98-010221 EXCOM Hybrid A2-ECOII, con unidad de control € 3.080,00

Ref.: 98-010222 EXCOM Hybrid A5 (230 V) – ECO II TANDEM con unidad de control € 4.080,00 → 

Ref.: 98-010224 EXCOM Hybrid A5 (400 V) – ECO II TANDEM con unidad de control € 4.128,00 → 

## MOTORES METASYS CUBIERTAS INSONORIZADORAS



Ref.: 98-110007 Cubierta insonorizadora para EXCOM Hybrid 1s - € 299,80→   
sin ventilador  
Reducción nivel sonoro 15%

Ref.: 98-110004 Cubierta insonorizadora para EXCOM Hybrid 1, 2, € 1.038,00→   
5, A1, A2 y A5 - con ventilador  
Reducción nivel sonoro 15%



## SEPARADOR DE AMALGAMA METASYS

ECO II



ECO II TANDEM



	ECO II	ECO II TANDEM
Caudal máx. agua	1l/min	2l/min
Tasa separación	99,30%	99,30%
Volumen recipiente colector	700 cm <sup>3</sup>	2 x 700 cm <sup>3</sup>
Intervalo de cambio	anual / lleno 100%	anual / lleno 100%
Dimensiones (Al x An x P) en mm	308 x 164 x 201 mm	371 x 407 x 243 mm
Peso en vacío con soporte / contenedor lleno	1,7 kg / 2,7 kg	3,6 kg / 2x2,7 kg
Suministro incluye	Kit básico instalación	Kit básico instalación

Ref.: 98-010004 ECO II

€ 758,00

Ref.: 98-010007 ECO II TANDEM

€ 1.358,00

## CENTRIFUGADORAS METASYS SIN SEPARACIÓN AMALGAMA

MST 1 ECO LIGHT



**MST 1 ECO LIGHT**

Tensión de alimentación	24 V AC
Frecuencia	50 / 60 Hz
Consumo máx. corriente	1,5 A
Consumo máx. potencia	46 VA
Caudal máx. agua	4,5 l/min
- desde escupidera	3,0 l/min
- desde línea de aspiración	1,5 l/min
Zona presión negativa regulada	50-250 mbar
Tasa separación	-
Volumen recipiente colector	300 cm <sup>3</sup>
Dimensiones (Al x An x P) en mm	305 x 163 x 104mm
Suministro incluye	Kit básico instalación
Garantía	36 meses*
* <i>Mínimo de mantenimiento requerido</i>	

Ref.: 98-010033 MST 1 ECO LIGHT sin separador de amalgama € 798,00

## CENTRIFUGADORAS METASYS CON SEPARACIÓN AMALGAMA

MST 1



COMPACT Dynamic



MST 1 (Modelo externo)



	MST 1	COMPACT Dynamic
Sistema de autolimpieza	Sí	Sí
Tensión de alimentación	24 V AC	24 V AC
Frecuencia	50 / 60 Hz	50 / 60 Hz
Consumo máx. corriente	2 A	6,3 A
Consumo máx. potencia	46 VA	100 VA
Caudal máx. agua	4,5 l/min	4,5 l/min
- desde escupidera	3,0 l/min	3,0 l/min
- desde línea de aspiración	1,5 l/min	1,5 l/min
Zona presión negativa regulada	80-250 mbar	80-160 mbar
Tasa separación	98,60%	96,40%
Volumen recipiente colector	300 cm <sup>3</sup>	300 cm <sup>3</sup>
Dimensiones (Al x An x P) en mm	305 x 210 x 104mm	301 x 173 x 110mm
Número de autorización DIBT (Instituto Alemán de Ingeniería Civil)	Z-64.1-4	Z-64.1-2
Suministro incluye	Kit básico instalación	Kit básico instalación
Garantía	36 meses*	36 meses*
* Mínimo de mantenimiento requerido		

Ref.: 98-010001 MST 1 con separador de amalgama € 2.180,00

Ref.: 98-010020 MST 1 con separador de amalgama (Modelo externo) € 2.238,00 → 

Ref.: 98-110001 COMPACT Dynamic con separador de amalgama € 2.580,00

## MANTENIMIENTO, REPUESTOS Y ACCESORIOS METASYS

### VÁLVULAS

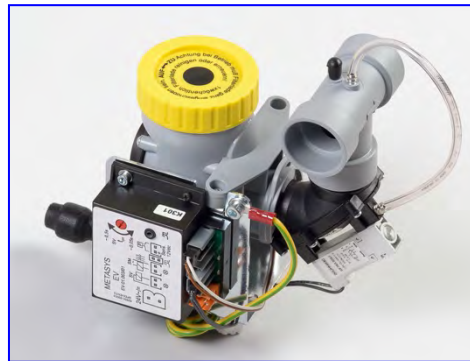
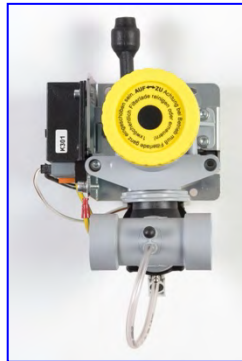

Ref.: 98-020002 Válvula escupidera 24 V DC / AC

€ 428,00

Garantía: 12 meses

Ref.: 98-030002F Filtro cesta Metasys MST1, A8 y  
escupidera, 10uds

€ 102,80



Ref.: 98-020048 Válvula selectora 24 DC / CC

€ 102,80

Ref.: 98-020044 Válvula selectora 24 AC / CA

€ 138,00

Ref.: 98-010003 Membrana válvula selectora Metasys

€ 10,80

**NOVEDAD!!!**

## REPUESTOS MOTORES ASPIRACIÓN

Ref.: 98-010210 Aspa y tapa superior (Centrífuga) € 448,00  
 Motores METASYS EXCOM Hybrid 1S, 1, 2, 5, A1, A2 y A5

## KITS MANTENIMIENTO MOTORES ASPIRACIÓN

Ref.: 98-010240 Kit mantenimiento anual motores € 143,80  
 METASYS EXCOM Hybrid 1, 2, A1 y A2  
Suministro incluye: colector de agua con válvula antiretorno, conexión adaptador para separación y tubo PVC

## KITS MANTENIMIENTO CENTRIFUGADORAS

Ref.: 98-010109 Kit inspección anual centrifugadora € 125,80  
 METASYS MST 1  
Suministro incluye: cuerpo básico de entrada con válvula antiretorno integrada, membrana válvula selectora, filtro bomba, contenedor reemplazo.

Ref.: 98-010110 Kit inspección 5 años centrifugadora € 344,80 →   
 METASYS MST 1  
Suministro incluye: (cuerpo básico de entrada con válvula antiretorno integrada, membrana válvula selectora, filtro bomba, contenedor reemplazo, cajón de filtro, tapa centrifugadora, anillo desplazamiento agua, deflector de aire, cámara de centrifugado y tapa bomba centrifugado.

Ref.: 98-010030 Kit inspección anual centrifugadora METASYS € 344,80 →   
 COMPACT Dynamic y COMPACT Dynamic ECO  
Suministro incluye: rotor completo, junta, parte superior separador c/membrana y contenedor reemplazo.

Ref.: 98-010031 Kit inspección 5 años centrifugadora € 428,00 →   
 METASYS COMPACT Dynamic  
Suministro incluye: rotor completo, junta, parte superior separador c/membrana y contenedor reemplazo + centrifugadora y filtro bomba.

Ref.: 98-010119 Kit inspección anual centrifugadora € 121,80  
 METASYS MST 1 ECO Light  
Suministro incluye: anillo desplazamiento agua, deflector aire, alojamiento entrada bomba k, membrana, válvula antiretorno, anillo tórico.



## CONTENEDORES SEPARADORES DE AMALGAMA

Ref.: 98-210001 Contenedor reemplazo METASYS MST 1	€	41,80
Ref.: 98-010005 Contenedor reemplazo METASYS COMPACT Dynamic	€	39,80
Ref.: 98-010130 Contenedor reemplazo METASYS ECO II y ECO II Tandem	€	259,80

## TUBO ENTRADA ASPIRACIONES

Tubo de entrada de aire de sistemas de aspiración

**\*(Compra mín. 1 metro referencia / múltiplos de 1m, NO fracciones)**

Ref.: 98-020050* Tubo entrada aspiraciones, Ø40mm, <u>x metro</u>	€	36,80	→ 
Ref.: 98-020051* Tubo entrada aspiraciones, Ø50mm, <u>x metro</u>	€	39,80	→ 



## TUBO DESAHOGO ASPIRACIONES

Tubo termo resistente para descarga de aire de sistemas de aspiración

**\*(Compra mín. 1 metro referencia / múltiplos de 1m, NO fracciones)**

Ref.: 98-020100* Tubo desahogo aspiraciones termo resistente, Ø32mm, <u>x metro</u>	€	69,80
Ref.: 98-020101* Tubo desahogo aspiraciones termo resistente, Ø40mm, <u>x metro</u>	€	73,80
Ref.: 98-020102* Tubo desahogo aspiraciones termo resistente, Ø50mm, <u>x metro</u>	€	80,00



FILTROS SALIDA ASPIRACIONES HEPA H14



FLUJO NOMINAL DE AIRE (m3/h)	ENTRADA A	SALIDA B	ENTRADA A (mm)	SALIDA B (mm)	C (mm)	D (mm)	$\phi_e$ (mm)	H (mm)	PESO (Kg)
144	G1 1/2"	G1 1/2"	38	38	95	98	173	156	1,7

- ✓ Filtro HEPA (High Efficiency Particulate Air) con nivel de filtración H14 (99,995%)
- ✓ Adaptable a todos los sistemas de aspiración dental, fácil de instalar y mantener
- ✓ Apto para hasta 5 sillones dentales (144 m3/h)
- ✓ Instalable al final o en la línea de la salida de aire
- ✓ Frecuencia de cambio de cartucho recomendada: 12 meses
- ✓ Material: microfibra HEPA H14
- ✓ Suministro incluye:
  - Filtro con cartucho
  - Tubo desahogo termoresistente (80cm apróx) D.40mm
  - Espigas PVC: 2uds. 1,0" x D.30mm y 2uds. : 2uds. 1 1/4" x D.40mm
  - Adaptadores PVC: 2uds. 1 1/4" x 1,0"
  - Abrazaderas metálicas: 2uds. para D.30mm y 2uds. para D.40mm

Ref.: 98-030011 Filtro salida aspiraciones HEPA H14 completo € 298,00

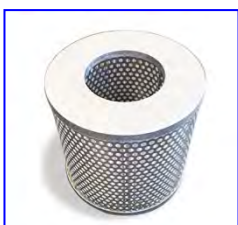

Ref.: 98-030011C Cartucho interno repuesto filtro salida aspiraciones HEPA H14 € 148,00

## CONECTORES META CONNECT

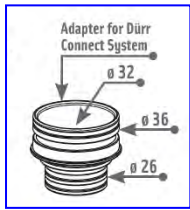

Ref.: 98-040124 Adaptador Dürr Connect (G) – META Connect Macho/Macho, 1ud. € 16,80

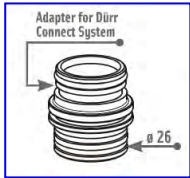

Ref.: 98-040084 Adaptador Dürr Connect (K) – META Connect Macho/Macho, 1ud. € 16,80

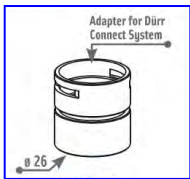

Ref.: 98-040102 Adaptador Dürr Connect (K) – META Connect Hembra/Hembra, 1ud. € 16,80

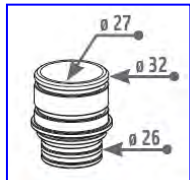

Ref.: 98-040125 Adaptador conexión d.i. Ø27, d.e. Ø32 – META Connect Macho/Macho, 1ud. € 16,80

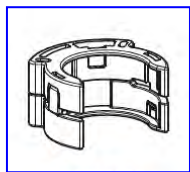

Ref.: 98-040103 META Connect clip cierre, 1ud. € 10,80



## LIMPIEZA ASPIRACIONES



**LIMPIADOR, DESINFECTANTE Y DESODORIZANTE GREEN & CLEAN**  
Doble concentrado desespumado activo para la limpieza diaria, desinfección y desodorización de sistemas de aspiración y separadores de amalgama.

- Apto para el mantenimiento de aspiraciones de todas las marcas
- Concentrado: fácil de transportar y no ocupa espacio
- Sistema dual especialmente diseñado para impedir la generación de microorganismos resistentes
- Extremadamente cómodo y sencillo:

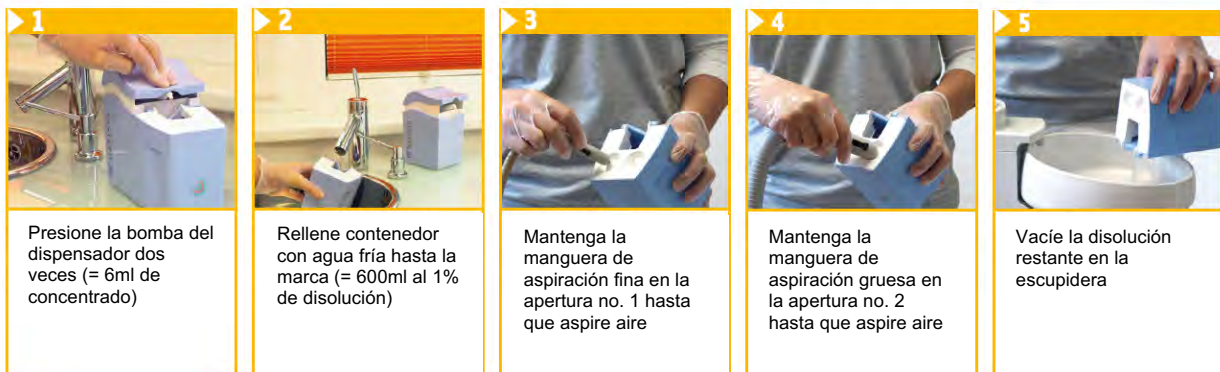

1  
Presione la bomba del dispensador dos veces (= 6ml de concentrado)

2  
Rellene contenedor con agua fría hasta la marca (= 600ml al 1% de disolución)

3  
Mantenga la manguera de aspiración fina en la apertura no. 1 hasta que aspire aire

4  
Mantenga la manguera de aspiración gruesa en la apertura no. 2 hasta que aspire aire

5  
Vacíe la disolución restante en la escupidera

Ref.: 98-030201 Kit iniciación Green & Clean M2 € 122,80  
(Aproximadamente 167 aplicaciones)

Suministro incluye: 1 x dispensador, 1 x M2 rojo 500ml y 1 x M2 verde 500ml

Ref.: 98-030202 Kit refill I Green & Clean M2 € 159,80  
(Aproximadamente 334 aplicaciones)

Suministro incluye: 2 x M2 rojo 500ml y 2 x M2 verde 500ml

Ref.: 98-030203 Kit refill II Green & Clean M2 € 79,80  
(Aproximadamente 167 aplicaciones)

Suministro incluye: 1 x M2 rojo 500ml y 1 x M2 verde 500ml

## LIMPIEZA BIOFILM SILLONES

### LIMPIADOR BIOFILM LÍNEAS AGUA SILLONES

Diseñado para al menos una vez al año el servicio técnico haga una limpieza integral de las líneas de agua limpia de los sillones dentales. Muy sencillo de utilizar por servicios técnicos.

Unos pocos sencillos pasos y una hora de actuación para que toda la red de tubos de agua limpia del sillón dental quede completamente limpia.

Evite obstrucciones en el sillón y en los instrumentos.

Sorprendente resultados!



Ref.: 98-030501 Bomba para BR + 1 botella limpiador BR 1.000ml € 458,00



Ref.: 98-030300 2 botellas limpiador BR 1.000ml c/u € 78,00

## MANTENIMIENTO ASPIRACIONES



- Limpiador especial de sistemas aspiración MD-555.
- Concentrado sin espuma para instalaciones dentales de aspiración y desagüe.
- Complemento idóneo para Orotol Plus para el cuidado completo y perfecta limpieza y mantenimiento de instalaciones de aspiración de todo tipo.

Ref.: 68-37003                      Botella 2,5 l, 1 ud.                      €      45,80



Ref.: 68-37001 FILTRO AMARILLO DÜRR, 12 uds.                      €      38,80  
(Ref. Dürr 0725.041.00)



Ref.: 68-37005\*\*FILTRO AMARILLO dos entradas                      €      108,00  
Dürr Connect  
(Ref. Dürr 0700.705.54)

**\*\*Adaptadores a manguera de 11mm y 17mm,  
consultar Refs.: 38-517 y 38-518**

## VÁLVULAS DÜRR



68-26001 Válvula antiretorno CAS1, CS1 y comp. 1ud.  
(Ref. Dürr 7117.420.43 - 1ud de 2) € 51,80



68-26002\* Retén CAS-1, 1ud. € 27,80  
**\* Hasta agotar existencias**

**NOVEDAD!!!**



68-36001 Válvula centralizadora/selectora aspiración  
(Ref. Dürr 7560.500.60E) € 180,00

68-36002 Membrana válvula centralizadora/selectora aspiración € 16,00  
(Ref. Dürr 7560.500.22)

68-36005 Válvula antiretorno Dürr Conect € 19,80  
(Ref. Dürr 7128.100.03)

## REPUESTOS ASPIRACIONES DÜRR

68-25001 Aspa/Turbina V300S y VS300S € 234,80  
(Ref. Dürr 7119.983.054) (Antigua 7119.933.55)

68-25002 Aspa/Turbina V600 y VS600 € 280,00  
(Ref. Dürr 7127.983.55)













68-25003 Tapa+ventilador V300S, VS300S, V600. VS600, V900S, € 94,80  
VS900S  
(Ref. Dürr 7130.982.54)

68-25004 Biofiltro HEPA H13 V300, VS300, VSA 300S € 198,00  
(Ref. Dürr R7119100010)

68-26003 Kit mantenimiento CS-1 € 118,00  
(Ref. Dürr 7117.980.33)

## CONECTORES DÜRR CONNECT

### DÜRR CONNECT K (20mm)

	68-87004	Dürr Connect hembra a 15mm (K), 5uds. (Ref. Dürr 0700.720.15E)	€ 18,80
	68-87003	Dürr Connect macho a 20mm (K), 5uds. (Ref. Dürr 0700.710.20E)	€ 18,80
	68-87020	Dürr Connect macho a 25mm (K), 5uds. (Ref. Dürr 0700.710.25E)	€ 18,80
	68-87021	Dürr Connect "T" 2 x macho / 1 x hembra, c/sifón (K), 3uds. (Ref. Dürr 0700.700.08E)	€ 33,80
	68-87014	Dürr Connect macho-macho (K), 5uds. (Ref. Dürr 0700.700.13E)	€ 18,80
	68-87005	Dürr Connect hembra a 17mm (K), 5uds. (Ref. Dürr 0700.720.17E)	€ 18,80
	68-87007	Dürr Connect hembra a 18mm (K), 5uds. (Ref. Dürr 0700.720.18E)	€ 18,80
	68-87017	Dürr Connect hembra a 20mm (K), 5uds. (Ref. Dürr 0700.720.20E)	€ 18,80
	68-87019	Dürr Connect hembra a 22mm (K), 5uds. (Ref. Dürr 0700.720.22E)	€ 18,80
	68-87006	Dürr Connect hembra a 25mm (K), 5uds. (Ref. Dürr 0700.720.25E)	€ 18,80
	68-87009	Dürr Connect hembra a 30mm (K), 3uds. (Ref. Dürr 0700.720.30E)	€ 18,80
	68-87008	Dürr Connect hembra 36mm (K), 5uds. (Ref. Dürr 0700.700.21E)	€ 18,80
	68-87013	Dürr Connect hembra-hembra (K), 5uds. (Ref. Dürr 0700.700.11E)	€ 18,80

	68-87018	Dürr Connect manguito a 32mm (K), 5uds. (Ref. Dürr 0700.700.20E)	€ 18,80
	68-87015	Dürr Connect codo 90° (K), 5uds. (Ref. Dürr 0700.700.04E)	€ 18,80
	68-87010	Dürr Connect tapón sencillo (K), 5uds. (Ref. Dürr 0700.700.10E)	€ 18,80
	68-87012	Dürr Connect "T" 1 x macho / 2 x hembra (K), 3uds. (Ref. Dürr 0700.700.06E)	€ 33,80
	68-87002	Dürr Connect "T", 3 x macho (K), 5uds. (Ref. Dürr 0700.700.02E)	€ 18,80
	68-87001	Dürr Connect "Y", 3 x macho (K), 5uds. (Ref. Dürr 0700.700.03E)	€ 18,80
	68-87011	Dürr Connect clip pequeño (K), 20uds. (Ref. Dürr 0700.700.01E)	€ 18,80
	68-87016	Dürr Connect anillo tórico (K), 1ud. (Ref. Dürr 9000.402.54)	€ 2,90
<b>DÜRR CONNECT G (32mm)</b>			
	68-88004	Dürr Connect clip grande (G), 20uds. (Ref. Dürr 0700.800.01E)	€ 32,80
	68-88005	Dürr Connect codo 90° (G), 3uds. (Ref. Dürr 0700.800.04E)	€ 48,00
	68-88003	Dürr Connect hembra a 30mm (G), 3uds. (Ref. Dürr 0700.820.30E)	€ 31,80
	68-88001	Dürr Connect macho a 30mm (G), 3uds. (Ref. Dürr 0700.810.30E)	€ 31,80
	68-88002	Dürr Connect macho-macho (G), 3uds. (Ref. Dürr 0700.800.13E)	€ 25,80

## SOPORTE ASPIRACIÓN SOPORTE COMPLETO 2 CÁNULAS



- Máxima fiabilidad + Máximo silencio.
- Tecnología única que garantiza el máximo mantenimiento poder de succión.
- Filtro fácilmente accesible para limpiarlo y cambiarlo, a través cubierta especial.
- La guía de metal suministrada con el soporte de cánula facilita su instalación.
- Garantía: 6 meses.

Ref.: 39-8200

€ 418,00

**CONSÚLTENOS POR SUS REPUESTOS**



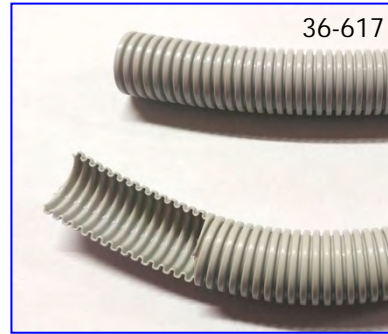
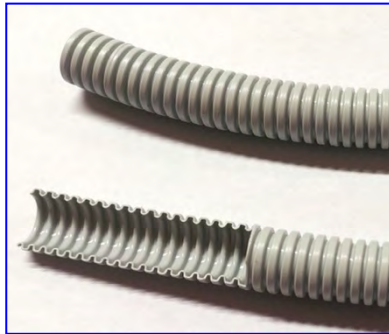

- Máxima calidad y durabilidad
- Manguera extra flexible de Etyl-Vinilo-Acetato.
- Corrugada interior y exterior.
- Resistente a todos los desinfectantes homologados.
- Color gris claro RAL 7035.

36-611R	EN ROLLO, LARGO 25 m. Diámetro interno 11 mm, 25m <u>Suministro incluye:</u> adoptadores silicona	€ 168,00
36-617R	Diámetro interno 17 mm, 25m	€ 198,00
CORTADAS A MEDIDA (NO ADMITEN DEVOLUCIÓN)		
36-611	Diámetro interno 11 mm ( <u>x metro</u> ) <u>Suministro incluye:</u> adoptadores silicona	€ 8,80
36-617	Diámetro interno 17 mm ( <u>x metro</u> )	€ 9,80



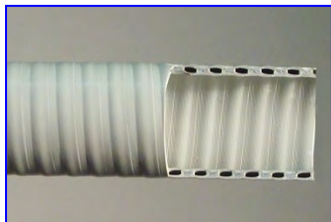

## MANGUERAS DE ASPIRACIÓN SOFT-PVC

- Primera calidad.
- Doble pared, reforzada de SOFT-PVC flexible.
- Muy buena flexibilidad.
- Resistente a todos los desinfectantes homologados.
- Color gris claro RAL 7035.

	CORTADAS, LARGO 160 cm	
36-008	Diámetro interno 8 mm	€ 18,00
36-011	Diámetro interno 11 mm	€ 18,00
36-015	Diámetro interno 15 mm	€ 18,00
36-017	Diámetro interno 17 mm	€ 18,80
36-020	Diámetro interno 20 mm	€ 21,80
	EN ROLLO, LARGO 12 m.	
36-051	Diámetro interno 11 mm	€ 129,80
36-057	Diámetro interno 17 mm	€ 139,80
	CORTADAS A MEDIDA (NO ADMITEN DEVOLUCIÓN)	
36-061	Diámetro interno 11 mm ( <u>x metro</u> )	€ 15,80
36-067	Diámetro interno 17 mm ( <u>x metro</u> )	€ 16,80
	CORTADAS, LARGO 160 CM CON TERMINAL	
36-111	Diámetro interno 11 mm	€ 28,00
36-117	Diámetro interno 17 mm	€ 28,80

**Wow!!**

## TERMINALES DE ASPIRACIÓN rm

- Resistente a todos los desinfectantes homologados.



38-517 Para mangueras de 11 mm interno (terminal + adaptador)€ 5,80  
(Montaje en manguera con pegamento)



38-518 Para mangueras de 17 mm interno (terminal + adaptador)€ 5,80  
(Montaje en manguera con calor)



46-387 Pequeño conector 6,35 - 7,00mm € 10,80



46-387P\* Punta terminal pequeño conector € 1,80  
**\* Próximamente disponible**



58-388 Grande conector 12,4 - 12,55mm € 10,80

## ADAPTADORES TERMINALES-CÁNULAS

- Resistentes.  
- Color crema.  
- Esterilizable en autoclave 135° C.



38-519/5 Adaptador terminal cánula salivador € 15,20  
(11mm int.) Bolsa 5 uds.



38-520/5 Adaptador terminal cánula niebla de spray y cirugía € 15,20  
(17mm int.) Bolsa 5 uds.

## TERMINALES DE ASPIRACIÓN DÜRR

- Calidad Dürr.
- Resistente a todos los desinfectantes homologados.

### MANGUERA GRUESA

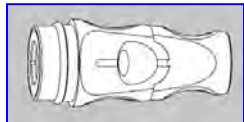
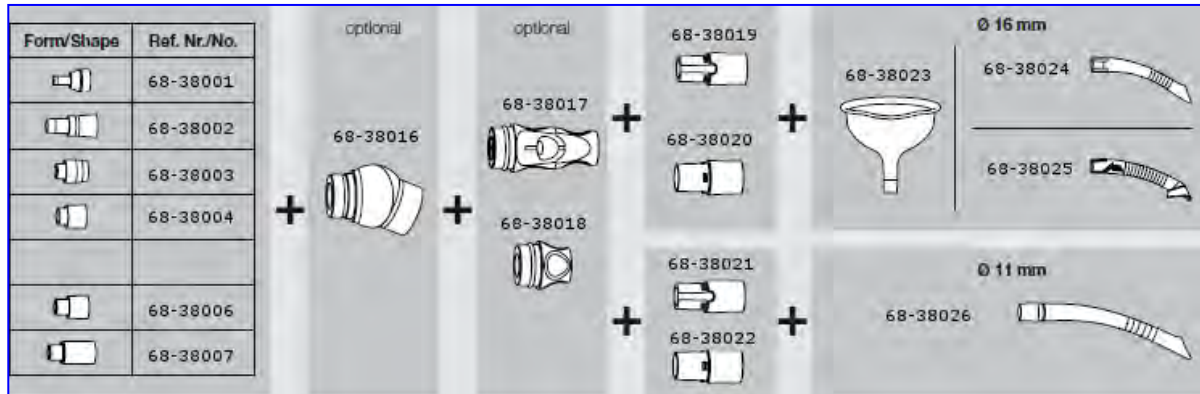

68-38017 Angular, tubo grueso, gris, con pestillo desplazamiento € 32,80



68-38018 Angular, tubo grueso, gris, sin pestillo desplazamiento € 18,80

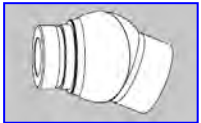

68-38016 Articulación gris terminal de aspiración grueso € 28,80

### MANGUERA FINA

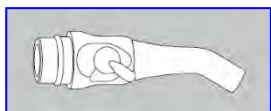
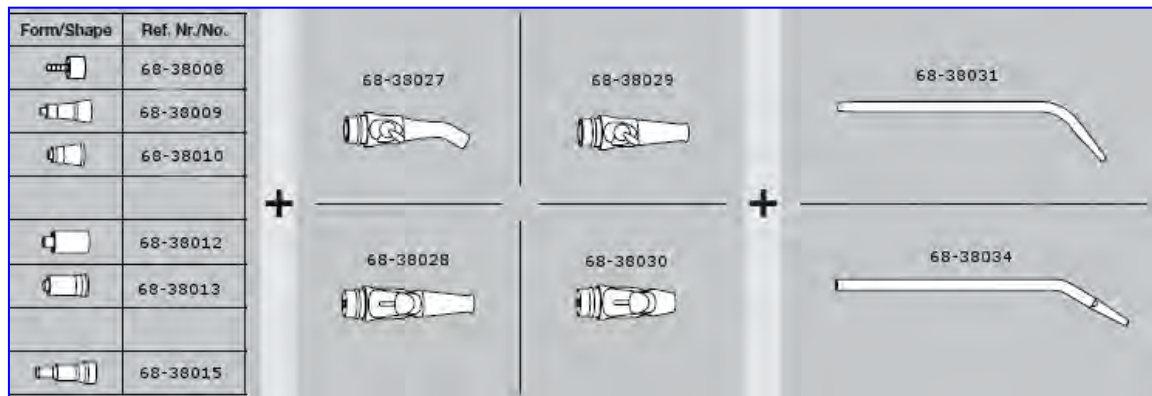

68-38027 Angular, tubo fino, gris, con pestillo giratorio € 31,80  
68-38027P Punta terminal angular, tubo fino, gris, 3uds. € 38,80

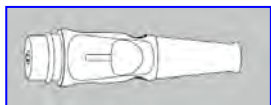

68-38028 Recta, tubo fino, gris, con pestillo deslizamiento € 28,00



68-38029 Recta, tubo fino, gris, con pestillo giratorio € 36,80

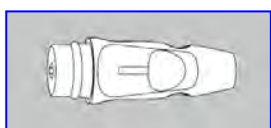

68-38030 Recta, tubo fino, gris, con pestillo deslizamiento € 21,80

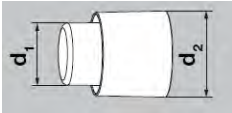

## ADAPTADORES MANGUERAS- TERMINALES DE ASPIRACIÓN DÜRR

- Calidad Dürr.
- Resistente a todos los desinfectantes homologados.

### MANGUERA GRUESA

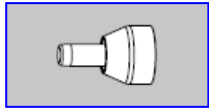

68-38001 Adaptador manguera-terminal universal 10mm  
(d.1: 10,0mm x d.2: 26,3mm) € 17,80

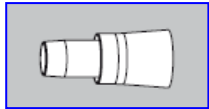

68-38002 Adaptador manguera-terminal A-dec 17mm  
(d.1: 17,0mm x d.2: 26,3mm) € 17,80

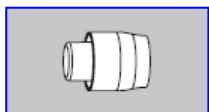

68-38003 Adaptador manguera-terminal KaVo 20mm  
(d.1: 20,0mm x d.2: 26,3mm) € 17,80

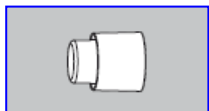

68-38004 Adaptador manguera-terminal Dürr Comfort  
(d.1: 19,0mm x d.2: 26,3mm) € 17,80

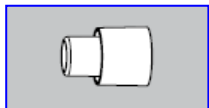

68-38006 Adaptador manguera-terminal universal 18mm  
(d.1: 18,0mm x d.2: 26,3mm) € 17,80

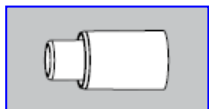

68-38007 Adaptador manguera-terminal universal 18mm  
(d.1: 18,0mm x d.2: 26,3mm) € 19,80

### MANGUERA FINA

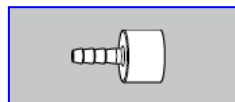

68-38008 Adaptador manguera-terminal universal 6mm  
(d.1: 6,0mm x d.2: 20,7mm) € 20,80

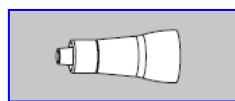

68-38009 Adaptador manguera-terminal A-dec 7,2mm  
(d.1: 7,2mm x d.2: 21,0mm) € 13,80

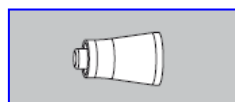

68-38010 Adaptador manguera-terminal KaVo 8mm  
(d.1: 8,0mm x d.2: 21,0mm) € 15,80

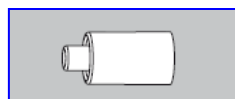

68-38012 Adaptador manguera-terminal Cattani 10mm  
(d.1: 10,0mm x d.2: 21,0mm) € 15,80

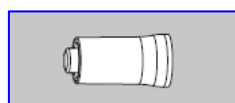

68-38013 Adaptador manguera-terminal Dürr Comfort  
(d.1: 10,0mm x d.2: 21,0mm) € 17,80

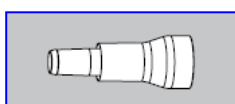

68-38015 Adaptador manguera-terminal universal 10mm  
(d.1: 10,0mm x d.2: 21,0mm) € 9,80

## ADAPTADORES TERMINALES- CÁNULAS Y CÁNULAS DE ASPIRACIÓN

- Calidad Dürr.
- Resistente a todos los desinfectantes homologados.

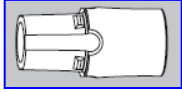

68-38019

**MANGUERA GRUESA**  
Manguito giratorio 16mm

€ 18,80

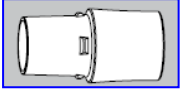

68-38020

Manguito giratorio 16mm

€ 7,30

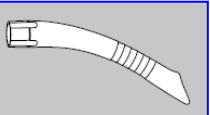

68-38024\*

Cánula aspiración universal protect, 16mm, gris, 5uds.  
(para refs.: 68-38019 y 68-38020) \* Hasta agotar existencias

€ 14,80

**Wow!!**

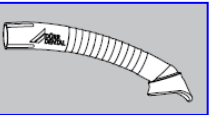

68-38025\*

Cánula aspiración profilaxis, 16mm, gris, 4uds.  
(para refs.: 68-38019 y 68-38020) \* Hasta agotar existencias

€ 16,80

**Wow!!**



68-38036\*

Cánula universal Petito, 16mm, gris, 5uds.  
\* Hasta agotar existencias

€ 11,80



68-38023\*

Embudo aspiración grande  
\* Hasta agotar existencias

€ 24,80

**Wow!!**

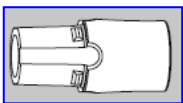

68-38021

**MANGUERA FINA**  
Manguito giratorio 11mm

€ 18,80

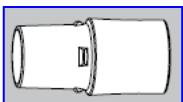

68-38022

Manguito giratorio 11mm

€ 7,30



68-38026\*

Cánula aspiración universal Petito, 11mm, gris, 5uds.  
(para refs.: 68-38021 y 68-38022) \* Hasta agotar existencias

€ 9,80



**Wow!!**



# PEDALES Y SUS REPUESTOS



## PEDALES FARO

80-224900000	Pedal con cable electroneumático P2L1 Faro	€ 449,80 → 
80-224900100	Pedal con cable neumático P2L1 Faro	€ 396,80 → 
80-224900200	Pedal con cable electrico P2L1 Faro	€ 396,80 → 
80-604497	Potenciómetro K10 pedal Faro	€ 18,00
80-604035	Válvula FARO 3 vías accionamiento pedal (Ref. Faro 224035)	€ 27,80
80-604920	Válvula proporcional flujo de aire pedales FARO 224900000 y 224900100 (Ref. Faro 224920)	€ 80,80
80-654954	Base plato pedal FARO (Ref. Faro 224954)	€ 5,50

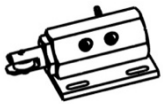

**CONSÚLTANOS POR MÁS REPUESTOS PARA PEDALES FARO**



PEDALES NEUMÁTICOS

- Regulación progresiva del flujo de aire.
- Disco de acero de Cromo pulido, muy resistente y duradero.
- Valvulería de primera calidad.
- Con almohadillas antideslizantes.



37-200

Pedal neumático con chip blower y con selector de agua (No manguera)\*

€ 108,00

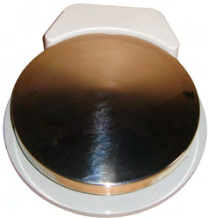

44-506

Pedal neumático sin chip blower y sin selector de agua (No manguera)\*

€ 74,80

\* VER MANGUERAS PARA PEDALES REFS.: 37-241, 37-242 Y 44-850

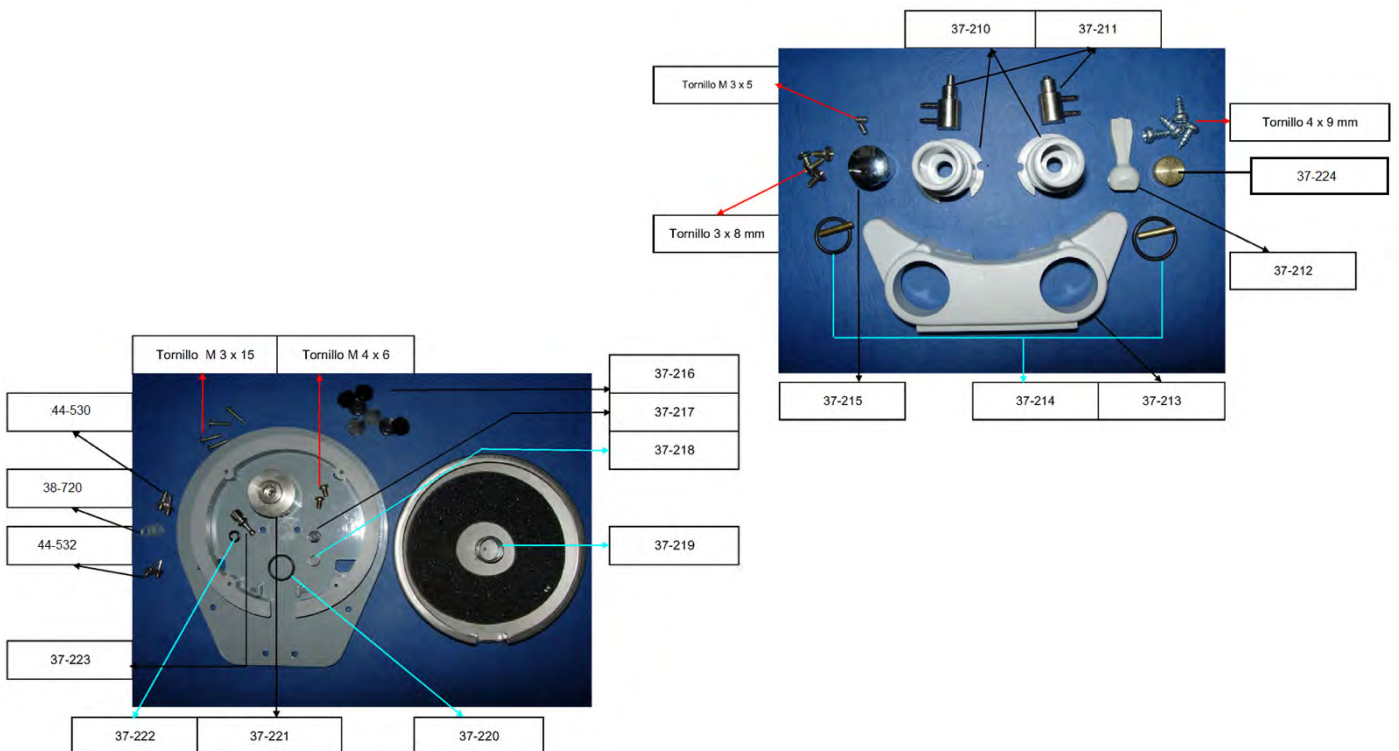



37-210	Base torre para válvulas con tornillo	€	9,80
37-211	Válvula Hanger con puertos laterales normalmente abierta + Pedales neumáticos RUMAR	€	13,80
37-212	Palanca control de agua	€	6,80
37-213	Base de mandos	€	31,80
37-214	Junta tórica con pasador	€	5,80
37-215	Chip Blower metálico	€	9,80
37-216	Patas de goma	€	2,80
37-217	Junta interna válvula central	€	1,40
37-218	Muelle interno válvula central	€	4,80
37-219	Muelle central válvula central	€	7,80
37-220	Anillo tórico base	€	2,00
37-221	Estructura válvula central	€	57,80
37-222	Junta tórica "U" pistón	€	2,00
37-223	Pistón sin junta tórica	€	7,80
44-532	Espiga manguera macho10/32" x 1,6mm (Compra mín. 5 uds. modelo / múltiplos de 5)	€	1,35
38-720	Anillo nylon rosca 10/32" (0,79x0,475x0,08mm) min 10 uds.	€	0,45
44-530	Espiga manguera macho10/32" x 4,6mm	€	1,30
37-224	Disco metálico válvulas	€	2,00
37-225	Torre completa palanca control de agua	€	31,80
37-226	Torre completa Chip-Blower	€	38,00

**IMPORTANTE:**

Válvula central completa = 37-217 + 37-218 + 37-220 + 37-221 + 37-222 + 37-223



## RACORES, CONECTORES Y ESPIGAS

- 1.- Racorería, conectores y llaves de paso
- 2.- Espigas
- 3.- Conectores de Nylon

## RACORERÍA

- Conexión rápida, serie SC.
- Latón niquelado.
- Primera calidad.



Rectos macho cónico Ref.: 50-009/5 3/8" x 8 mm, 5uds	€ 11,80
Ref.: 50-001/5 1/4" x 6 mm, 5uds	€ 8,25
Ref.: 50-002/5 1/4" x 8 mm, 5uds	€ 8,25
Ref.: 50-003/5 1/8" x 6 mm, 5uds	€ 7,75
Ref.: 50-004/5 1/8" x 8 mm, 5uds	€ 8,00



Rectos hembra Ref.: 50-005/5 1/4" x 6 mm, 5uds	€ 10,00
Ref.: 50-006/5 1/4" x 8 mm, 5uds	€ 10,80
Ref.: 50-007/5 1/8" x 6 mm, 5uds	€ 8,25
Ref.: 50-008/5 1/8" x 8 mm, 5uds	€ 8,80



Codos fijos, macho Ref.: 50-011/5 1/4" x 6 mm, 5uds	€ 10,50
Ref.: 50-012/5 1/4" x 8 mm, 5uds	€ 10,50
Ref.: 50-013/5 1/8" x 6 mm, 5uds	€ 8,25
Ref.: 50-014/5 1/8" x 8 mm, 5uds	€ 8,80



Codos fijos, hembra Ref.: 50-015/5 1/4" x 6 mm, 5uds	€ 13,00
Ref.: 50-016/5 1/4" x 8 mm, 5uds	€ 13,50
Ref.: 50-091/5 1/8" x 6 mm, 5uds	€ 10,75
Ref.: 50-092/5 1/8" x 8 mm, 5uds	€ 11,25



Codos Intermedios

Ref.: 50-021 6 mm, 5uds

€ 11,80

Ref.: 50-022 8 mm, 5uds

€ 14,00



Prolongadores

Ref.: 50-025/5 6 x 6 mm, 5uds

€ 11,25

Ref.: 50-026/5 8 x 8 mm, 5uds

€ 12,50

Ref.: 50-027/5 6 x 8 mm, 5uds

€ 12,50



"T" Intermedias

Ref.: 50-031/5 6 x 6 x 6 mm, 5uds

€ 16,50

Ref.: 50-033/5 8 x 8 x 6 mm, 5uds

€ 18,50

Ref.: 50-032/5 8 x 8 x 8 mm, 5uds

€ 19,00



"T" Lateral macho cónico

Ref.: 50-035 1/4" x 6 mm, 1ud.

€ 3,60

Ref.: 50-036 1/4" x 8 mm, 1 ud.

€ 3,60



"T" Central macho cónico

Ref.: 50-041 1/4" x 6 mm, 1ud.

€ 3,60

Ref.: 50-042 1/4" x 8 mm, 1ud.

€ 3,60



Cruz intermedia

Ref.: 50-045 6 mm, 1ud.

€ 5,10

Ref.: 50-046 8 mm, 1ud.

€ 5,90

## CONECTORES RÁPIDOS AIRE EASY

RUMAR



Rectos macho

Ref.: 50-070/5 1/4" x 8 mm, 5uds

€ 11,25

Ref.: 50-071/5 1/4" x 6 mm, 5uds

€ 10,95

Ref.: 50-072/5 1/8" x 8 mm, 5uds

€ 11,25

Ref.: 50-073/5 1/8" x 6 mm, 5uds

€ 10,75

## UNIONES RÁPIDAS ENGANCHE METÁLICO (SISTEMA ANTI ESCAPE DE TUBOS - MAYOR DURABILIDAD)



Uniones		
Ref.: 50-087/5	4mm x 4mm, 5uds.	€ 13,90
Ref.: 50-081/5	6mm x 6mm, 5uds.	€ 15,00
Ref.: 50-082/5	8mm x 8mm, 5uds.	€ 17,40



Uniones reductoras		
Ref.: 50-083/5	6mm x 8mm, 5uds.	€ 18,00
Ref.: 50-088/5	4mm x 6mm, 5uds.	€ 17,10



"T" Intermedias		
Ref.: 50-080/5	8 x 8 x 8 mm, 5uds.	€ 27,50
Ref.: 50-084/5	6 x 6 x 6 mm, 5uds.	€ 25,00



## CONECTORES RÁPIDOS AGUA/AIRE DCI



Ref.: 52-0011	Hembra conexión rápida agua/aire para tubo de 4x6mm	€ 19,80
	<u>Suministros incluye:</u> arandelas de colores para identificación (Aire o Agua)	



Ref.: 52-0014	Macho conexión rápida agua/aire para tubo de 4x6mm	€ 16,80
	(Aire o Agua)	

## ACCESORIOS



Ref.: 50-061	Válvula Antirretorno 1/4"	€ 7,30
--------------	---------------------------	--------

Ref.: 50-066	Válvula Antirretorno 1/8"	€ 6,20
--------------	---------------------------	--------



Ref.: 44-570	Mini válvula Antirretorno 10/32" x 1,6mm	€ 9,80
--------------	--	--------



Ref.: 44-571	Mini válvula Antirretorno 1,6mm x 1,6mm	€ 11,80
--------------	---	---------



Uniones

Ref.: 50-085/5	Unión 1/4" macho a 1/4" macho, 5uds.	€	5,75
Ref.: 50-086/5	Unión 1/8" macho a 1/8" macho, 5uds.	€	4,50



Reductores

Ref.: 50-062/5	Reductor 1/4" macho a 1/8" hembra, 5uds.	€	4,25
Ref.: 50-064/5	Reductor 3/8" macho a 1/4" hembra, 5uds.	€	5,50
Ref.: 50-067/5	Reductor 1/2" macho a 1/4" hembra, 5uds.	€	12,00
Ref.: 44-565/5	Reductor 1/8" macho a 10/32" hembra, 5uds.	€	27,50



Ref.: 50-063/5	Reductor 1/8" macho a 1/4" hembra 5uds.	€	5,80
Ref.: 50-068/5	Reductor 1/4" macho a 3/8" hembra 5uds.	€	10,80



Ref.: 50-065	Pinza cortatubos, modelo PT	€	12,90
--------------	-----------------------------	---	-------

Llaves de paso



Ref.: 50-250	Llave de paso 1/4" macho/macho	€	10,50
Ref.: 50-251	Llave de paso 1/4" macho/hembra	€	7,70
Ref.: 50-252	Llave de paso 1/4" hembra/hembra	€	7,70
Ref.: 50-253	Llave de paso 1/8" macho/hembra	€	7,20



Espigas manguera, macho

\*\*\*3,2mm = tubo d.i. 4mm (Ref.: 50-100 y 50-10025)

\*\*2,5mm = tubo d.i. 2,8mm (Ref.: 44-520 y 44-521)

\*1,6mm = tubo d.i. 1,4mm (Ref.: 44-525 y 44-526)

Ref.: 50-051/5	1/4" x 6 mm, 5uds.	€	5,80
Ref.: 50-052/5	1/4" x 8 mm, 5uds.	€	6,20
Ref.: 50-053/5	1/8" x 6 mm, 5uds.	€	5,00
Ref.: 50-054/5	1/8" x 8 mm, 5uds.	€	5,00

	Ref.: 44-530/5 10/32" x 3,2 mm***, 5uds.	€ 6,50
	Ref.: 44-542/5 10/32" x 2,5 mm**, 5uds.	€ 6,50
	Ref.: 44-532/5 10/32" x 1,6 mm*, 5uds.	€ 6,75
	Ref.: 44-540/5 M5 x 3,2 mm***, 5uds.	€ 6,50
	Ref.: 44-541/5 M5 x 1,6 mm*, 5uds.	€ 6,50
	Ref.: 44-537/5 10/32" x 3,2 mm, (rosca extra larga)***, 5uds.	€ 6,50
	Ref.: 44-538/5 10/32" x 1,6 mm (rosca extra larga)*, 5uds.	€ 6,75
	Ref.: 38-535/5 8/32" x 1,6 mm*, 5uds.	€ 6,50
	Uniones macho/macho	
	Ref.: 44-533/5 reductora 3,2mm*** a 2,5mm**, 5uds.	€ 10,00
	Ref.: 44-534/5 reductora 3,2mm*** a 1,6mm*, 5uds.	€ 11,00
	Ref.: 44-535/5 reductora 2,5mm** a 1,6mm*, 5uds.	€ 11,00
	Ref.: 44-536/5 uniones 1,6mm* a 1,6mm*, 5uds.	€ 11,00
	Tapón macho	
	Ref.: 50-055/5 1/4", Allen con tórica, 5uds.	€ 5,00
	Ref.: 50-056/5 1/8", cabeza hexagonal, 5uds.	€ 5,00
	Ref.: 44-539/5 10/32", cabeza hexagonal, 5uds.	€ 3,75
	Abrazaderas de seguridad de metal	
	Ref.: 44-550 Para tubo de 1,6x2,5mm	€ 0,75
	Ref.: 44-551 Para tubo de 2,5x4mm	€ 0,75
	Junta de Nylon / Nylon washers	
	Ref.: 38-720 Rosca 10/32" y M5 (0,79x0,475x0,08mm), 10uds.	€ 4,50
	Ref.: 38-721 Rosca #6 (0,709x0,353x0,08mm), 10uds.	€ 4,50
	Ref.: 38-722 Rosca #8 (0,63x0,41x0,08mm), 10uds.	€ 4,50

## TUBOS

RUMAR



### POLIURETANO, azul

(Compra mín. 10 m modelo / múltiplos de 5)

(Formato por metro: NO ADMITEN DEVOLUCIÓN)

Ref.: 50-100	4 x 6 mm	(máx 10 bar)	por metro	€	1,80
Ref.: 50-10025	4 x 6 mm	(máx 10 bar)	caja 25m	€	30,80
Ref.: 50-101	6 x 8 mm	(máx 20 bar)	por metro	€	2,00
Ref.: 50-10125	6 x 8 mm	(máx 20 bar)	caja 25m	€	36,80

## CONECTORES DE NYLON

RUMAR



### UNIONES

Ref. 50-300	1,6 X 1,6 mm,	pack 10 uds	€	9,80
Ref. 50-301	2,4 X 2,4 mm,	pack 10 uds	€	9,80
Ref. 50-302	3,2 X 3,2 mm,	pack 10 uds	€	9,80

### UNIONES REDUCTORAS



Ref. 50-350	4 mm x 1,6 mm,	pack 10 uds	€	11,80
Ref. 50-351	4 mm x 2,4 mm,	pack 10 uds	€	11,80
Ref. 50-352	3,2 mm x 1,6 mm,	pack 10 uds	€	9,80
Ref. 50-353	3,2 mm x 2,4 mm,	pack 10 uds	€	9,80

### "L"



Ref. 50-310*	1,6 X 1,6 mm,	pack 10 uds	€	12,20
	* Hasta agotar existencias			
Ref. 50-311*	2,4 X 2,4 mm,	pack 10 uds	€	13,10
	* Hasta agotar existencias			
Ref. 50-312*	3,2 X 3,2 mm,	pack 10 uds	€	13,10
	* Hasta agotar existencias			

### "T"



Ref. 50-320	1,6 mm,	pack 10 uds	€	13,80
Ref. 50-321	2,4 mm,	pack 10 uds	€	13,80
Ref. 50-322	3,2 mm,	pack 10 uds	€	13,80



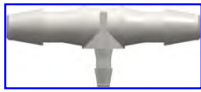

"T" REDUCTORA

Ref. 50-323 2X3,2mm + 1X1,6mm, pack 10 uds € 14,30



Ref. 50-324 2X3,2mm + 1X2,4 mm, pack 10 uds € 14,30



"Y"

Ref. 50-330 1,6 mm, pack 10 uds € 11,80

Ref. 50-331\* 2,4 mm, pack 10 uds € 11,25  
\* Hasta agotar existencias

Ref. 50-332\* 3,2 mm, pack 10 uds € 11,25  
\* Hasta agotar existencias



CRUZ

Ref. 50-340\* 1,6 mm, pack 10 uds € 18,20  
\* Hasta agotar existencias

Ref. 50-341\* 2,4 mm, pack 10 uds € 18,20  
\* Hasta agotar existencias

Ref. 50-342\* 3,2 mm, pack 10 uds € 18,20  
\* Hasta agotar existencias



TAPONES

Ref. 50-360 1,6 mm, pack 10 uds € 6,80

Ref. 50-361 2,4 mm, pack 10 uds € 6,80

Ref. 50-362 3,2 mm, pack 10 uds € 6,80



## VÁLVULAS Y ELECTROVÁLVULAS

- 1.- Válvulas (Faro, Clippard, RUMAR)
- 2.- Electroválvulas (Sirai / ASCO NEUMATICS)

## VÁLVULAS



### VÁLVULAS FARO

	80-603400	Válvula FARO agua selección de instrumentos (Ref. Faro 223400)	€ 48,80
	80-604035	Válvula FARO 3 vías accionamiento pedal (Ref. Faro 224035)	€ 27,80
	80-604639	Válvula FARO apertura agua con aspiración (Ref. Faro 224639)	€ 74,80
	80-604679	Válvula FARO agua comando aire (Ref. Faro 224679)	€ 91,80
	80-604248	Distribuidor FARO (entrada 1x3,2mm / salidas: 3x1,6mm (Ref. Faro 234248)	€ 68,80
	80-604920	Válvula proporcional flujo de aire pedales FARO 224900000 y 224900100 (Ref. Faro 224920)	€ 80,80
	80-603033	Membrana válvula FARO agua (Ref. Faro 223033)	€ 5,80
	80-603147	Membrana válvula FARO instrumento neumática (Ref. Faro 223147)	€ 5,50
	80-603252	Membrana válvula FARO instrumento eléctrica (Ref. Faro 223252)	€ 5,80

	80-603162	Válvula FARO solenoid 24V DC /CC (Ref. Faro 223162)	€ 48,80
	80-603164	Válvula FARO solenoid 24V AC/CA (Ref. Faro 223164)	€ 57,80
	80-654331	Interruptor electroneumático FARO (Ref. Faro 224331)	€ 30,80
	80-604265	Válvula doble FARO, un sentido (Ref. Faro 224265)	€ 45,80
	80-608030	Llave de regulación FARO aire/agua c/ empuñadura (Ref. Faro 118030)	€ 41,80
	80-607070	Llave de regulación FARO aire/agua 1,6mm, s/empuñadura (Ref. Faro 117070)	€ 22,80
	80-600367	Llave de regulación FARO aire/agua 2,6mm, s/empuñadura (Ref. Faro 200367)	€ 22,80
	80-604170	Llave de regulación FARO aire/agua 3,2mm, s/empuñadura (Ref. Faro 224170)	€ 22,80

## BLOQUES VÁLVULAS FARO



- 80-603300 Bloque 3 instrumentos (operación eléctrica) 24V DC/CC € 428,00  
(Ref. Faro 223300)  
**También disponible para 1 o 2 instrumentos y sin tapa de cierre. Consultar**



- 80-603305 Bloque 3 instrumentos (operación eléctrica) 24V AC/CA € 428,00  
(Ref. Faro 223305)  
**También disponible para 1 o 2 instrumentos y sin tapa de cierre. Consultar**



- 80-603345 Bloque 4 vías, 3 instrumentos (operación neumática) € 329,80  
(Ref. Faro 223345)  
**También disponible para 1 instrumento y sin tapa de cierre. Consultar**



- 80-603149 Bloque 2 instrumentos (operación neumática) € 252,80  
(Ref. Faro 223149)

- 80-600128 Espiga para bloques y válvulas Faro tubo 2,6mm/3,2mm € 4,20  
(Ref. Faro 250128)

- 80-600129 Espiga para bloques y válvulas Faro tubo 1,5mm/2,0mm € 4,20  
(Ref. Faro 250129)

- 80-600131 Junta de Nylon para espigas bloques y válvulas Faro € 0,90  
(Ref. Faro 250131)

- 80-609025 Ampliación de bloques Faro: (Ver páginas siguientes)  
Tuerca ampliación bloques Faro € 1,10  
(Ref. Faro 609025)

- 80-603208 Tornillo ampliación bloques Faro L=33mm (+1 puesto) € 3,20  
(Ref. Faro 223208)

- 80-603166 Tornillo ampliación bloques Faro L=55mm (+2 puestos) € 4,40  
(Ref. Faro 223166)

80-605019	Anillo tórico bloques Faro (Ref. Faro 055019)	€ 0,90
80-603201	Módulo neumático para ampliación de bloques Faro (Ref. Faro 223201)	€ 118,80
80-603255	Módulo eléctrico AC para ampliación de bloques Faro (Ref. Faro 223255)	€ 150,80
80-603250	Módulo eléctrico DC para ampliación de bloques Faro (Ref. Faro 223250)	€ 150,80



Ampliación bloque neumático:

**80-603345**

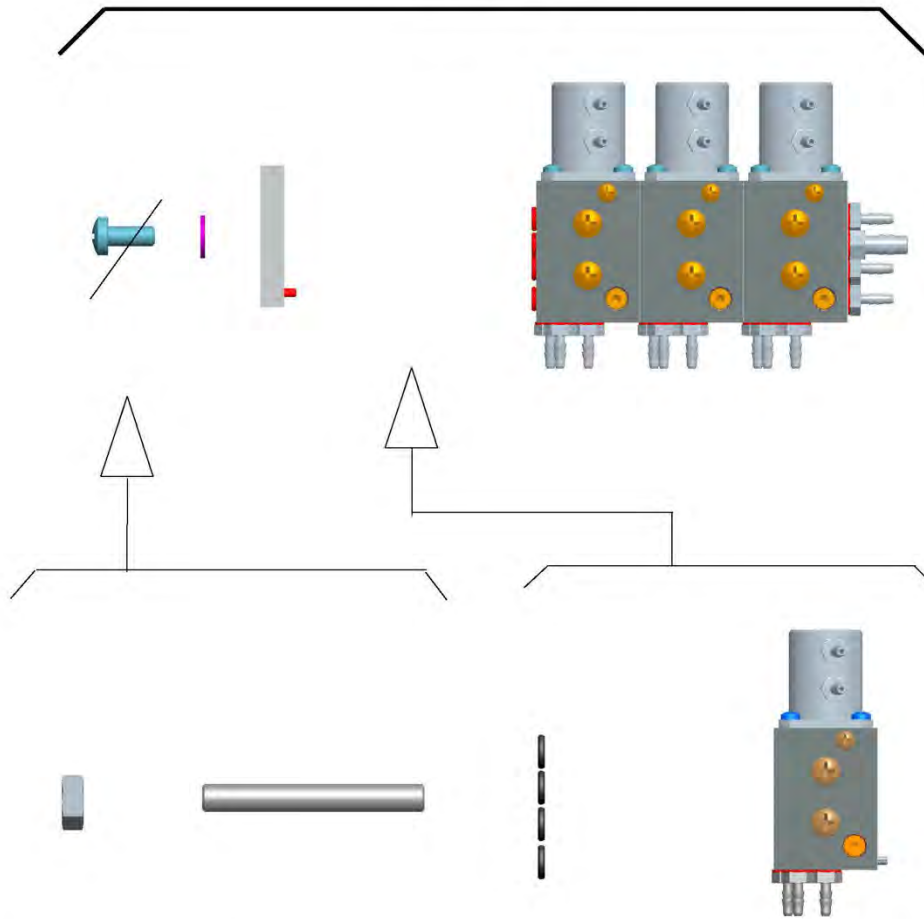

**80-609025**

**80-603208**  
(+1 PUESTO)

**80-605019**

**80-603201**

**80-603166**  
(+2 PUESTO)

Ampliación bloque eléctrico CA/AC:

**80-603305**

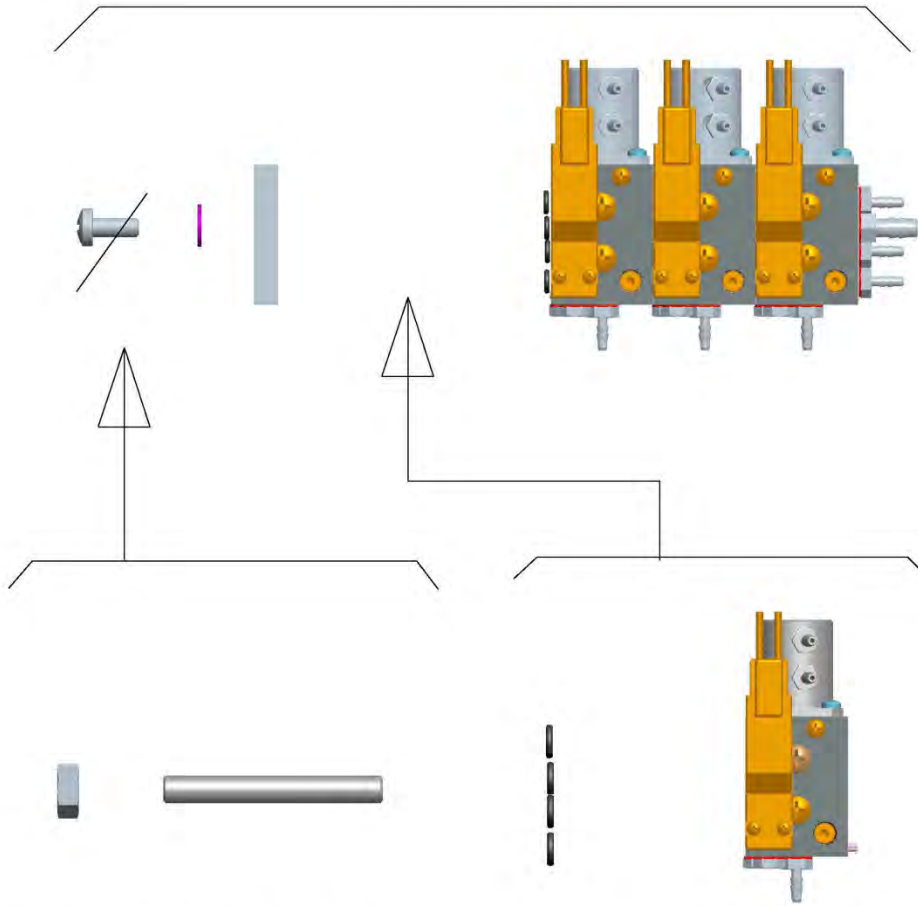

**80-609025**

**80-603208**  
(+1 PUESTO)

**80-605019**

**80-603255**

**80-603166**  
(+2 PUESTO)



Ampliación bloque eléctrico CC/DC:

### 80-603300

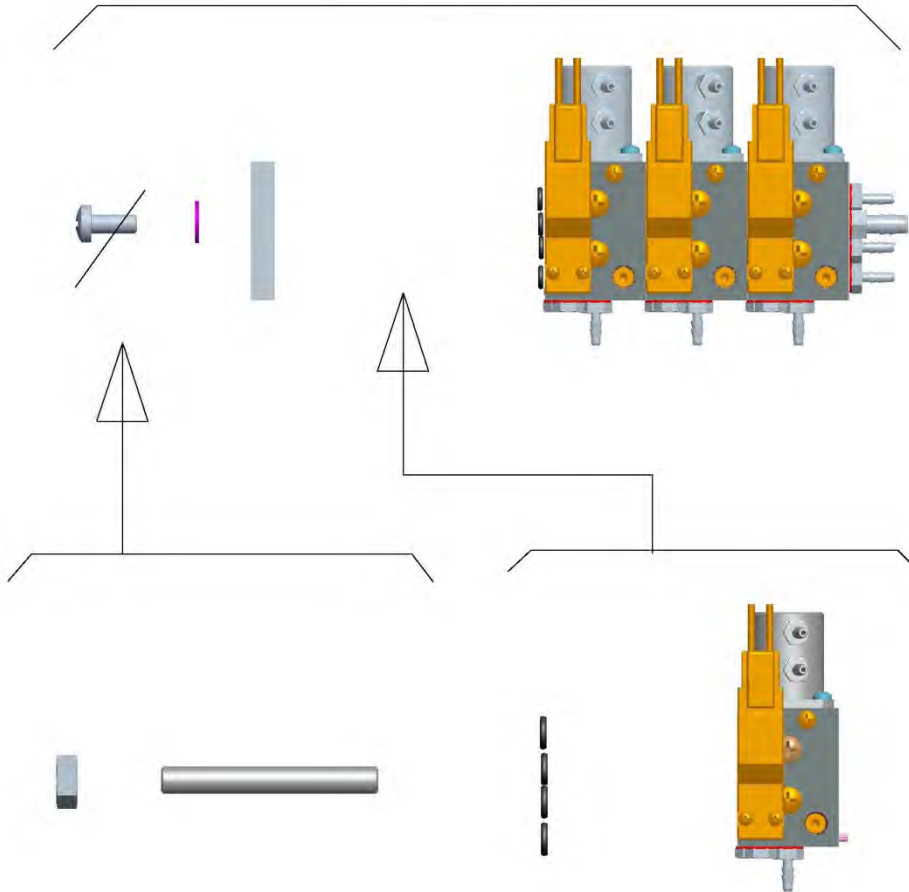

**80-609025**

**80-603208**  
(+1 PUESTO)

**80-605019**

**80-603250**

**80-603166**  
(+2 PUESTO)

**OTRAS REFERENCIAS DISPONIBLES CONSÚLTANOS**

## VÁLVULAS BLOQUES rm

- Primera calidad.
- Acabados y tolerancias según normas DIN.
- Garantía 6 meses.



Ref.: 38-703 Válvula bloque RUMAR 3 instrumentos, tipo DCI € 80,00  
puertos de 10/32" (incluye espigas)



Ref.: 38-704 Válvula bloque RUMAR 4 instrumentos, tipo DCI € 88,80  
puertos de 10/32" (incluye espigas)



Ref.: 38-713 Válvula bloque RUMAR 3 instrumentos, Standard € 80,00  
puertos de 10/32" (incluye espigas)



Ref.: 38-714 Válvula bloque RUMAR 4 instrumentos, Standard € 88,80  
puertos de 10/32" (incluye espigas)

### Membranas bloques rm:

Ref.: 38-7031 Membrana bloque RUMAR 3 instrumentos € 14,80  
(Ref.: 38-703), tipo DCI

Ref.: 38-7041 Membrana bloque RUMAR 4 instrumentos € 14,80  
(Ref.: 38-704), tipo DCI

Ref.: 38-7131 Membrana bloque RUMAR 3 instrumentos € 14,80  
(Ref.: 38-713), standard

Ref.: 38-7141 Membrana bloque RUMAR 4 instrumentos € 14,80  
(Ref.: 38-714), standard

## VÁLVULAS CLIPPARD

- Primera calidad.
- Acabados y tolerancias según normas DIN.
- Garantía 3 meses.

*Clippard*



Ref.: 44-600 Válvula Clippard antigoteo Relay WDV-2, € 46,80  
puertos 10/32" (Sólo agua)



Ref.: 44-602 Válvula Clippard corte aire/agua sin retracción, € 53,80  
puertos 10/32" (Aire o agua)



Ref.: 44-620 Mini válvula Clippard SMAV-3 control pértigas colibrí € 53,80  
(Sólo Aire)

## VÁLVULAS rm

- Primera calidad.
- Acabados y tolerancias según normas DIN.
- Garantía 3 meses.

	Ref.: 44-590	Válvula antigoteo, puertos de 10/32" <u>incluye:</u> espigas de 10/32" x 1,6mm <u>(Sólo agua)</u>	€	28,80
	Ref.: 38-740	Válvula neumática ON/OFF, 3 vías y puertos de 10/32", normalmente cerrada <u>(Sólo agua)</u>	€	25,80
	Ref.: 37-211	Válvula Hanger con puertos laterales normalmente abierta	€	13,80
	Ref.: 38-731	Válvula Hanger con puertos laterales normalmente cerrada	€	13,80
	Ref.: 38-732*	Válvula Hanger con puertos traseros normalmente abierta <u>* Hasta agotar existencias</u>	€	8,80
	Ref.: 38-733*	Válvula Hanger con puertos traseros normalmente cerrada <u>* Hasta agotar existencias</u>	€	8,80
	Ref.: 38-735	Válvula ON/OFF con palanca gris, 2 vías, liberación rápida y puertos de 10/32" <u>(Aire o agua)</u>	€	14,00
	Ref.: 38-737	Válvula cartucho selectora con palanca gris, 3 vías, liberación rápida y puertos de 10/32" <u>(Aire o agua)</u>	€	28,80
	Ref.: 44-581	Válvula de regulación de caudal puertos 10/32" (1puerto lateral / 1 puerto inferior) <u>(Aire o agua)</u>	€	11,80
	Ref.: 44-582	Miniregulador presión de agua Puertos 10/32" <u>(Incluye espigas 1,6mm)</u>	€	24,80
	Ref.: 44-583	Válvula doble para jeringas 3F Puertos 10/32" <u>(NO incluye espigas)</u>	€	12,80
	Ref.: 38-738	Válvula control dirección con palanca, 3 vías Puertos 10/32" <u>(Aire o agua)</u>	€	19,80

Asco™



## ELECTROVÁLVULAS SIRAI / ASCO NEUMATICS

- SIRAI / ASCO / EMERSON
- Primera calidad.
- Acabados y tolerancias según normas DIN.
- Garantía 3 meses.



Ref.: 54-L172011 Electroválvula escupidera L172V03, 1/8"x2, € 48,00  
24V+/-10% AC/CA, 50-60 Hz., 4W, n/c,  
diámetro de paso: **2,4mm**, juntas Vitón,  
°C fluido: de 0°C a 130 °C  
(Aire o agua)



Ref.: 54-L172012 Electroválvula escupidera L172V03, 1/8"x2, € 48,00  
24V+/-10% DC/CC, 5,5W, n/c,  
diámetro de paso: **2,4mm**, juntas Vitón,  
°C fluido: de 0°C a 130 °C  
(Aire o agua)



Ref.: 54-V165012 Electroválvula colibrí/ultrasonidos V165V01, € 50,80  
M5x2, 24V+/-10% DC/CC, 4W, n/c,  
diámetro de paso: **2,0mm**, juntas Vitón,  
°C fluido: de 0°C a 130 °C  
(Aire o agua)



Ref.: 54-V124012 Electroválvula V124D03, 24V+/-10% DC/CC, € 56,80  
4W, n/c, juntas EPDM,  
°C fluido: de -10°C a 100 °C  
(Aire y agua)



Ref.: 54-L121012 Electroválvula entrada L121V02, 1/4"x2, € 64,80  
24V+/-10% DC/CC, 9W, n/c,  
diámetro de paso: **4,5mm**, juntas Vitón,  
°C fluido: de 0°C a 130 °C  
(Aire, agua o vapor)



Ref.: 54-L121013 Electrovalvula entrada L121V02, 1/4"x2, 230V+/-10%, 50Hz., AC/CA, 14W, n/c, diámetro de paso: **4,5mm**, juntas Vitón, °C fluido: de 0°C a 130 °C  
(Aire, agua o vapor) € 64,80



Ref.: 54-L321012 Electrovalvula entrada L321V02G, 3 vias: 1/4"x2 + 1/8"x1, 24V+/-10% DC/CC, 12W, U (universal), diámetro de paso: **2,3mm**, juntas Vitón, °C fluido: de 0°C a 130 °C  
(Aire, agua o vapor) € 94,80



Ref.: 54-V162012 Electrovalvula V162B02, M5x2, 24V+/-10% DC/CC, 4W, n/c, diámetro de paso: **2,4mm**, juntas Nitrilo, °C fluido: de 0°C a 90 °C  
(Aire o agua) € 63,80



Ref.: 54-V164012 Electrovalvula V164B02, M5x2, 12-24V+/-10% DC/CC, 4W, n/c, proporcional, diámetro de paso: **1,6mm**, juntas Nitrilo, °C fluido: de -10°C a 90 °C  
(Aire o agua) (antigua V164B05) € 116,80



Ref.: 54-L194012 Electrovalvula L194D01, 1x1,8" / 1x1,6mm, 24V+/-10% DC/CC, 5,5W, n/c, proporcional, diámetro de paso: **1,6mm**, juntas Vitón, °C fluido: de 0°C a 130 °C  
(Aire o agua)  
Usada en sillones Cefla entre otros (hay que aprovechar los conectores del anterior) € 112,80



Ref.: 54-V625012 Grupo 3 microactuariales, V625D01, 3x1,6mm, 12-24V+10%-5% DC/CC, 4W, n/c, diámetro de paso: **1,6mm**, juntas EPDM, °C fluido: de -10°C a 90 °C  
(Aire o agua)  
Usada en sillones Vitali entre otros € 191,80

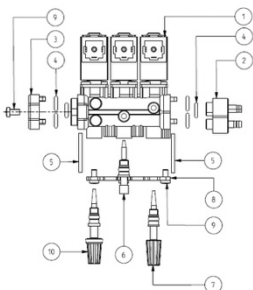

Ref.: 54-G3144801 Kit reparación para válvula ASCO V625D1 € 46,80  
Incluye: Cabezal alimentación, cabezal lateral final, tornillo, anillo tórico y pin.

## VÁLVULAS ELECTRONEUMÁTICAS rm

- Primera calidad.
- Acabados y tolerancias según normas DIN.
- Garantía 3 meses.

RUMAR



Ref.: 44-580    Micro electroneumático puerto de 10/32"    €    22,80  
normalmente cerrada  
(incluye: espiga de 10/32" x 4,6mm)  
Info Técnica: 15A, ½ HP 125 250 VAC, 0,6A 125VCD,  
0,3A 250VDC.











## REGULADORES DE PRESIÓN

- 1.- Reguladores y accesorios
- 2.- Repuestos depósito agua destilada

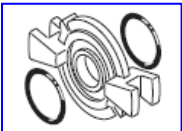

## REGULADORES DE PRESIÓN

	50-263	Regulador de presión de aire 0,8 – 8 bar 1/4" hembra / hembra, 20 bar máx 180 lt./min (con tuerca y manómetro) Manómetro: 40mm	€ 43,00
	50-261	Regulador de presión de aire c/filtro de agua 0 – 16 bar, 1/4" hembra / hembra, 240 lt./min cuerpo y base fundición de Zinc 14,4 m3 / h (con manómetro) Manómetro: 40mm	€ 78,00
	50-272	Manómetro 0-12 bar, 1/8" MTG, <u>40mm</u>	€ 5,80
	50-604800*	Filtro aire completo, 1/8" hembra/hembra, 7 bar máx (Ref. Faro 224800) *Compatible con unión 80-604803.	€ 36,80
	50-604801*	Regulador presión de aire 0-6 bar, 1/8" hembra/hembra 10 bar máx, 250 NI/min (Ref. Faro 224801) *Compatible con unión 80-604803.	€ 36,80
	50-604802	Manómetro 0-12 bar, 1/8" MTG, <u>25mm</u> (Ref. Faro 224802)	€ 19,80
	50-604805*	Filtro agua completo, 1/8" hembra/hembra, 7 bar máx (Ref. Faro 224805) *Compatible con unión 80-604803.	€ 39,80
	50-604806*	Regulador de presión de agua, 1/8" MTG (Ref. Faro 224806) *Compatible con unión 80-604803.	€ 48,00
	50-604803	Unión reguladores / filtros (Ref. Faro 224803)	€ 2,80



## ACCESORIOS REGULADORES DE PRESIÓN



50-270 Escuadra-soporte regulador € 3,80  
(para referencias 50-263 y 50-261)



50-271 Tuerca regulador € 4,00  
(para referencias 50-263 y 50-261)

## REPUESTOS DEPÓSITOS DE AGUA DESTILADA\*

\*SÓLO ASEGURAMOS COMPATIBILIDAD CON LOS TANQUES DE AGUA DESTILADA DE RUMAR



50-205 Conector rápido, gris (entrada) € 16,80  
"sin adaptador"



50-206 Conector rápido, negro (salida) € 16,80  
"sin adaptador"



50-207 Adaptador/conector negro, 6mm € 5,80

50-210 Tapa con válvula de desahogo € 32,80

50-211 Junta tapa € 4,80

50-212 Válvula de desahogo € 7,80

50-213 Anillos tóricos conectores € 0,90

50-214 Conector entrada € 14,80

50-215 Conector salida € 14,80

50-216 Tubo interno líquido € 8,00



## HERRAMIENTAS

- 1.- Herramientas instrumental rotatorio
- 2.- Herramientas equipos

## HERRAMIENTAS LLAVES TAPA / BOTÓN TURBINA

	KaVo		
05-KE1650T	609C, 619 L/C, 636 C/CP, 650 B/C, 655 B/C, 660 B/C, 6000 B/C, 7000 B/C, 8000 B/C, M9000 /L (utilizable con llaves dinamométricas 05-RT2025 y 05-RT2026)	€	33,80
30-604	Llave doble: Lado A (4 puntos): 609C, 619 L/C, 636 C/CP, 650 B/C, 655 B/C, 660 B/C, 6000 B/C, 7000 B/C, 8000 B/C, M9000 /L Lado B (3 puntos): S605, S605C, S615C, S615L, E677, E677LM, E675, E680, E680L y E679	€	23,80
30-609	630/639/642/645/640 B/C	€	33,80
05-KE1637T	635/637 B/C (utilizable con llaves dinamométricas 05-RT2025 y 05-RT2026)	€	33,80
	MK-dent		
05-KE1023T	4012/4022/5022/6012/6022/7022/8022/9022 (utilizable con llaves dinamométricas 05-RT2025 y 05-RT2026)	€	33,80
05-KE1650T	HP21, HC21, HE21, HC8021 y HC9021 (utilizable con llaves dinamométricas 05-RT2025 y 05-RT2026)	€	33,80
05-KE1921*	8021/9021	€	23,80
05-KE1651T	HC20 (utilizable con llaves dinamométricas 05-RT2025 y 05-RT2026)	€	33,80
	W&H		
05-KE1096W	Turbinas W&H, cabezas mini (Excepto TE-97 / TE-98) (2 muescas)	€	23,80
49-840	Turbinas W&H Synea TA98 y compatibles (2 muescas)	€	39,80
30-602	Llave doble: Lado A (3 muescas): TA97 y TE97 Lado B (3 muescas): TA98LED	€	43,80
30-606	Turbinas W&H Alegria TE98 / TE95, Trend TC80BC, TC-95BC, 398, 698, 795, 798, 895, 898 (2 muescas)	€	39,80
30-610	Llave doble: Lado A (Hexagonal): turbinas W&H Alegria HS2014 TE97 Lado B (Cuadrada): Cabezas FPB-Y / TI-MAX X25 /L, S-MAX M25 /L	€	39,80
49-829	Turbinas W&H Alegria HS2014 TE95 y HS2014 TE98 (hexagonal)	€	39,80

	<b>Bien Air</b>		
49-802	Llave doble: Lado A (2 puntos): Tapa interna/Bisel Bora, Cromo, Boralina Lado B (2 puntos): Tapa externa Bora , Cromo, Boralina	€	39,80
49-803	Llave doble : Lado A: Interna y externa turbinas Bien Air Prestige Lado B: Externa turbinas Bien Air Ondine.	€	39,80
49-831	Tapa Tornado (N/S<16E0001)	€	39,80
	<b>Sirona</b>		
30-591	Llave triple (2 muescas): T1/T2/T3 Control, Racer, Siroboost y Mini	€	18,80
30-592	Llave doble: Lado A (3 muescas): T1 Control Lado B (3 muescas): Mini	€	18,80
30-612	T1/T2/T3 Boost (N/S>600.000)(3 muescas)	€	39,80
	<b>Castellini</b>		
49-800	Hi Power M, Clean Air	€	35,80
49-810	Silent Power Gold, Silent Power Gold M, Hi Power Light	€	35,80
49-822	Silent Power EVO 2 /2L / 4L / 4LK	€	34,80
49-823	Silent Power EVO Miniature / Miniature K	€	34,80
49-824	Silent Power Silver 2 /2L / 4L / 4LK	€	34,80
	<b>NSK</b>		
15-008*	Llave doble: Lado A ( <u>11,30 mm octogonal</u> ): Ti-Max X500L / KL / SL / WL / BL, NL9000M, PanaMax TUM4 Lado B ( <u>10,00 mm octogonal</u> ): Pana Air, Rainbow <b>* Hasta agotar existencias</b>	€	12,40
30-600	Llave doble: Lado A ( <u>10,60 mm hexagonal</u> ): NL45S,Ti-Max NL95 S, Ti-Max A600L, A600, AK600L, AS600L, AW600L, AB600L,Ti-Max AK300L, AS300L, AW300L, AB300L, Ti-Max AK450L, AS450L, AW450L, AB450L,NL-45T, NL95T, A700L, A700, AK700L, AS700L, AW700L, AB700L, Phatelus 45 S/SU, Phatelus II S/SU, Ti-Max NL75 Mach Light S, NL85 Mach Light/ NL65S, Mach Lite XT S/SU y Lado B ( <u>10,95 mm hexagonal</u> ): Ti-Max X600L / KL / SL / WL / BL / Ti-Max NL9000S / KS / SS / WS / BS	€	23,80
15-107	Ti-Max NL95M, Ti-Max A500L, A500, AK500L, AS500L, AW500L, AB500L y Pana Air ( <u>9,60 mm octogonal</u> )	€	12,40

15-009*	Llave doble Rainbow Nuevo modelo: Lado A (12,30 mm hexagonal) Lado B (10,90 mm hexagonal) <b>* Hasta agotar existencias</b>	€	14,80	
30-605	Llave doble: Lado A (12,90 mm octogonal): Ti-Max X700L / KL / SL / WL / BL, Ti-Max NL9000T / KT / ST / WT / BT Lado B (11,30 mm hexagonal): Ti-Max X500L / KL / SL / WL / BL, NL9000M	€	23,80	
30-614	Llave doble: Lado A: Ti-Max Z800 Lado B: Ti-Max Z900	€	23,80	
30-632	Llave doble: Lado A: S-Max M600, S-Max M600L Lado B: Pico	€	18,80	
40-410	TKD Bravia	€	39,80	→ 
40-411	Thera	€	29,80	→ 
30-603	Multiusos Multiusos: Lado A (9,60 mm hexagonal) Lado B (8,10mm cuadrada) Lado C (10,20 mm cuadrada) Lado D (4 puntos)	€	12,40	
58-252K	RUMAR ECO T2, ECO T3 L, PRO T1L	€	4,80	
58-253K	ECO T TURBO	€	4,80	
<b>LLAVES TAPAS DE SPRAY TURBINAS</b>				
05-KE1022KT	KaVo 630/640/642/645/647B/650/655/660 (utilizable con llaves dinamométricas 05-RT2025 y 05-RT2026)	€	33,80	
05-KE1022KT	MK-dent Todos los modelos con 3-Spray hasta N/S: G (utilizable con llaves dinamométricas 05-RT2025 y 05-RT2026)	€	33,80	
05-KE1922	HC8021, HC9021, HP21, HC20, HC21, HC17, HE21	€	23,80	

42-629	RM PowerMax	€ 19,60
--------	----------------	---------

### SACA GOLPES CABEZAS



44-920	Saca golpes Bien Air Bora	€ 34,80
--------	---------------------------	---------



44-926	Saca golpes Bien Air Black Pearl	€ 34,80
--------	----------------------------------	---------



44-921	Saca golpes NSK Ti-Max X600	€ 38,00
--------	-----------------------------	---------



44-927	Saca golpes NSK S-Max M600	€ 34,80
--------	----------------------------	---------



44-928	Saca golpes NSK Ti-Max Z900	€ 34,80
--------	-----------------------------	---------



44-922	Saca golpes KaVo 642 B/C y comp.	€ 34,80
--------	----------------------------------	---------



44-925	Saca golpes KaVo 655, 650, 660, 7000, 8000 y comp.	€ 34,80
--------	--	---------



44-923	Saca golpes W&H TA98LED y comp.	€ 34,80
--------	---------------------------------	---------



44-924	Saca golpes W&H TA98 y comp.	€ 34,80
--------	------------------------------	---------



## LLAVES PARA CABEZAS CONTRA-ÁNGULOS

KaVo y MK-dent

05-KE2011T Llave tapa cabezas contra ángulos MK-dent LCH11, LCH21, LPH11, LPH21, LS9011, LS9021, LS9111, LS9121 (utilizable con llaves dinamométricas 05-RT2025 y 05-RT2026) € 36,80



49-817 Llave tapa cabezas contra ángulos KaVo 25LH, 25LHS, 25CN, 25CH, 25LS, 24LN, 24LS € 34,80



49-819 Llave tapa cabezas contra ángulos KaVo E25, E25L, 25CN, 25CH, 25LS, 24LN, 24LS € 28,80

05-KE1023T Llave tapa cabezas contra ángulos MK-dent LS9016 (utilizable con llaves dinamométricas 05-RT2025 y 05-RT2026) € 33,80

**NOVEDAD!!!**

44-751 Llave doble tapas cabezas contra ángulos: Lado A (2 lados rectos): KaVo 67LDN, 68LDN Lado B (3 puntos): KaVo L67, L68, 67LH, 68LH € 49,80



**NOVEDAD!!!**

44-753LDN Punta para llave 44-751 para tapa cabezas contra ángulo: (2 lados rectos): KaVo 67LDN, 68LDN € 19,80

**NOVEDAD!!!**

44-753LH Punta para llave 44-751 para tapa cabezas contra-ángulo: (3 puntos): KaVo L67, L68, 67LH, 68LH y compatibles € 19,80

49-832 Llave tapa cabeza CL3 € 39,80



44-752 Mandril de montaje anillo de conducción 05-SP2007 Cabezas LS9011 / 68LH € 38,80

05-RT2016 Destornillador hexagonal miniatura Whera para tornillo 05-SP2021 cabezas KaVo / MK-dent € 21,80



05-RT2027 Destornillador miniatura Whera plano 0,25x1,2x40 mm € 19,80



05-RT2028 Destornillador miniatura Whera plano 0,23x1,5x40 mm € 19,80





05-RT2013 Placa especial para colocar rodamientos de cabezas de contra-ángulos MK-dent / KaVo (Ref. KaVo 0.410.0724) € 48,80



44-950 W&H y NSK  
Llave especial desmontaje eje intermedio CA W&H WS75 y WD56, y CA NSK S-Max SG20, S-Max SG20L, Ti-Max X-SG20L, Ti-Max X-DSG20L € 38,00

**NOVEDAD!!!**

30-616 Llave doble: € 34,80  
Lado A (hexagonal): Tapa-botón cabeza contra ángulos NSK S-Max SG20/L y Ti-Max X-SG20L, Ti-Max X-DSG20L  
Lado B (dos puntos): eje contra ángulos NSK S-Max SG20 /L Ti-Max X-SG20L, Ti-Max X-DSG20L y eje contra ángulos W&H WI-75

30-610 Llave doble: € 39,80  
Lado A (hexagonal): turbinas W&H Alegria HS2014, TE97 Cabezas FPB-Y  
Lado B (cuadrada): Ti-MAX X25 /L, S-MAX M25 /L

**NOVEDAD!!!**

49-839 Llave para NSK FX15, FX25 y FX23 € 38,00

30-611 Llave contra-ángulo NSK: MP-F, MPA-Y, MPAS-Y y compatibles. € 39,80

49-820 Llave tapas cabezas contra ángulos W&H Synea WA-99A € 34,80

**NOVEDAD!!!**

30-613 Llave tapa cabeza Contra-Ángulo Ti-MAX Ti25 /L € 9,80

44-762\* Llave tapa cabezas contra ángulos NSK M95, M95L X95 y X95L € 9,80  
\* Hasta agotar existencias

30-615 Llave doble € 23,80  
Lado A (9,57mm hexagonal): NSK X95, X95L, M95, M95L  
Lado B (8,65mm hexagonal): Z95 y Z95L

**NOVEDAD!!!**

44-763 Llave doble: € 44,80  
Lado A: tapa cabeza contra ángulo W&H WE-56 LED G  
Lado B: Eje W&H WE-56 LED G



### Sirona

49-835 Llave tapa CA X-Smart 6:1 € 39,80



49-818 Alicates tapa cabezas contra ángulos Sirona standard (Ref. Sirona 4178054) € 98,00



49-821 Alicates tapa cabezas contra ángulos Sirona mini (Ref. Sirona 5986208) € 98,00



44-761 Alicates doble tapa cabezas contra ángulos Sirona (mini y standard) € 38,00

### Castellini

49-833 Llave tapa-botón de contra ángulo Goldspeed S1 y S1L € 39,80 → 

49-834 Llave tapa-botón de contra ángulo Goldspeed EVO S1 y S1L € 39,80 → 

### WOODPECKER

**NOVEDAD!!!** 28-28048 Llave tapa-botón de contra ángulo WP-1 y WP-1L € 13,80

**NOVEDAD!!!** 28-28049 Kit reparación contra ángulo WP-1 y WP-1L € 23,80

### LLAVES PARA CONTRA-ÁNGULOS Y PIEZAS DE MANO KaVo



05-KE2011BT Llave anillo de cierre trasero contra ángulos y piezas de mano MK-dent / KaVo (utilizable con llaves dinamométricas 05-RT2025 y 05-RT2026) (Ref. KaVo 0.411.1881) € 38,00



05-RT2011 Extractor pieza frontal 05-SP1031 piezas de mano MK-dent y KaVo (Ref. KaVo 0.410.2391) € 81,80



05-RT2015 Extractor especial desmontaje componentes interiores Contra ángulos y piezas de mano MK-dent / KaVo (Ref. KaVo 0.411.4451) € 69,80



05-RT2012 Extractor pieza frontal contra ángulos MK-dent / KaVo € 101,80  
(Ref. KaVo 0.411.2381)



05-RT2014 Llave especial para desmontaje de ejes de Transmisión piezas de mano rectas MK-dent / KaVo € 11,80 →   
(Ref. KaVo 0.411.1443)

### LLAVES PARA MICROMOTORES MK-dent

05-KE2014 Llave apertura micromotor MK-dent AM1116 € 33,80  
(para anillo SP1060)

05-KE2034 Llave apertura micromotor MK-dent AM1004 € 38,00

TKD  
40-10010 Llave apertura micromotor TKD DEFINITIVE y TKD VORTICE € 42,80

### LLAVES PARA MICROMOTORES NOUVAG PREGÚNTANOS

LLAVES PARA ACOPLAMIENTOS  
05-KE1029 Kavo Multiflex y MK-dent QC4014K y QC5016K € 8,00

20-911 Mandril de desmontaje Kavo Multiflex y MK-dent QC4014K y QC5016K (Original KaVo) (Ref. KaVo 411.3853) € 74,80

### LLAVES PARA PULIDORES BICARBONATO

05-KE2021K MK-dent PR1011 / Micron Quick Jet / BA Ultimate € 59,80  
BA720, sección acople KaVo

05-KE2021S MK-dent PR1011 / Micron Quick Jet / BA Ultimate € 59,80  
BA720, sección acople Sirona

05-KE2021W MK-dent PR1011 / Micron Quick Jet / BA Ultimate € 59,80  
BA720, sección acople W&H

05-KE2022 MK-dent PR1011 / Micron Quick Jet llave 1/ BA Ultimate € 59,80  
BA720

05-KE2023 MK-dent PR1011 / Micron Quick Jet llave 2/ BA Ultimate € 42,80  
BA720

## HERRAMIENTAS DE MEDICIÓN Y DEMOSTRACIÓN



- 05-SC1011 Probador para comparar bombillas € 25,80
- Especial para la presentación de bombillas LED.
  - Muestra la luminosidad de 2 bombillas de forma comparativa.
  - Pilas y bombillas (zócalo KaVo) NO incluidos.



- 05-RT1020 Dinamómetro digital para medir fuerza de retención pinzas rotores turbinas € 118,00



- 28-LM1 Medidor digital de potencia de polimerización € 49,80
- Mide tanto luces LED como halógenas hasta una intensidad de 3500mw/cm2

**MICRON®**



- 45-100 Contador móvil de revoluciones y frecuencias: € 1.180,00
- Mide de 5.000 a 950.000 rpm.
  - Mide frecuencias de 1 a 200.000 Hz.
  - Display LED, numérica decimal.
  - Medidas 76x118x18 mm.
  - Peso 120 gr.
  - Ideal para medir las rotaciones de cualquier instrumento rotatorio eléctrico o neumático y las frecuencias de cualquier ultrasonidos eléctrico o neumático.

- 45-102 Fresa de turbina especial contador (1,6 mm) € 83,00

- 45-103 Fresa de contra-ángulo especial contador (2,35 mm) € 83,00

- 45-104 Magneto para puntas ultrasonido especial contador € 39,80

- 45-105 Sensor receptor especial contador € 148,00



44-754

Microscopio económico de bolsillo con LED 60X € 31,80



98-050005

Manómetro digital Metasys con adaptadores € 368,00  
 - Es un instrumento de medición para presiones negativas y aire comprimido.  
 - Rango de presiones: -1 a 30 bar  
 - Permite la medición exacta de la presión de aspiración, aire y agua en sillones dentales

44-101

Multimanómetro: € 148,00  
 - Conexión Midwest 4.  
 - Mediciones precisas en bares.  
 - Compacto.  
 - Uso en todos los equipos.  
 - Acabados de primera calidad.  
 - Para toda la vida.  
 - Uso: medición de consumo de:  
 - Aire de empuje,  
 - Aire de retorno,  
 - Aire de spray y  
 - Agua de spray.



40-208

Manómetro para aire de empuje: € 145,80  
 - Conexión Midwest 4 y Midwest 4 LUX  
 - Doble escala de medición en PSI y bares.  
 - Uso en todos los equipos.  
 - Instrumento de primera calidad y precisión.  
 - Uso: medición de presión de aire de empuje.



## HERRAMIENTAS DE REPARACIÓN TURBINAS Y CONTRA-ÁNGULOS



- 05-RT2010 Prensa de precisión  
 - Capacidad hasta 1,5kN.  
 - Recorrido 40 mm.  
 - Altura de trabajo 50 – 240 mm.  
 - Medidas de la mesa: 110 x 60 mm.  
 - Orificio en la base: 20 mm.  
 - Alojamiento del eje: diámetro 10 x 25 mm.  
 - Peso: aprox. 9 kg.  
 - Incluye: 05-RT1033.  
 Nota: herramientas 05-RT1031 y 05-RT1032 son necesarias para el uso de la prensa.

€ 688,00



- 05-RT1011 Extractor de rodamientos turbina  
 diámetro exterior 6,350mm (universal) y pista  
 interna con todos sus accesorios

€ 188,00



- 05-RT1011L Pinza pista externa para extractor 05-RT1011

€ 51,80



- 05-RT1011S Pinza pista interna para extractor 05-RT1011

€ 51,80



- 05-RT1011SC Tornillo ataque delantero para extractor  
 05-RT1011

€ 48,00













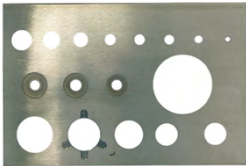

- 05-RT1011SO Tornillo ataque trasero para extractor 05-RT1011

€ 48,00



- 44-260 Extractor de rodamientos turbina  
 diámetro exterior 6,350mm (universal),  
diámetro exterior 7,938mm (Bora y compatibles)  
 y pista interna con todos sus accesorios

€ 168,00

	05-RT1012	Bloque universal de colocación y extracción de rodamientos	€ 188,80
	05-RT1013	Colocador de rodamientos universal para rodamientos 3,175 x 6,350 mm	€ 43,80
	05-RT1031	Punta ataque trasero para prensa 05-RT2010	€ 42,80
	05-RT1032	Punta ataque delantero para prensa 05-RT2010	€ 42,80
	05-RT1033	Pieza de reducción (para prensa 05-RT2010)	€ 26,80 → 
	05-RT1034	Punta para armar tapa KaVo 8000 (para prensa 05-RT2010)	€ 42,80
	05-RT2025	Llave dinamométrica 0,3 – 1,2 Nw (para tapas cabezas y tapas spray)	€ 118,00
	05-RT2026	Llave dinamométrica 1,2 – 3,0 Nw (para anillos cierre CA's y PM's)	€ 118,00
	44-750	Pletina de extracción rodamientos de turbinas	€ 8,80
	05-RT2018	Placa extracción de rodamientos turbinas	€ 48,80
	05-RT2017	Placa extracción de rodamientos universal 1,0/1,5/2,0/2,5/3,0/3,5/4,0/4,5/5,0/6,5/7,0 mm	€ 157,80



05-LT648 Pegamento LOCTITE 648, 10ml  
(Rodamientos – ejes) € 29,80



05-LT221 Pegamento LOCTITE 221, 10ml  
(Tapas y tornillos) € 28,00



05-LT306 Pegamento LOCTITE 306, 50ml € 93,80



05-LT7063 Limpiador de pegamento LOCTITE 7063, 150ml € 13,80



48-29523\* Puntero de acero (diámetro 1mm) con guía  
de hierro. € 9,80  
*\*Especial para pasadores*



44-760 Pinza de Baquelita para sujeción sin rayaduras € 54,80

## EMBALAJES

(Precios especiales por packs 100 uds.)



01-26080 Tubo embalaje instrumentos transparente  
L: 80-120mm D: 26mm (SIN LOGOS) € 1,10

01-24120 Tubo embalaje instrumentos transparente  
L: 120-200mm x D: 24mm (SIN LOGOS) € 1,10

## HERRAMIENTAS DE DESATASCO



44-020

SMART CLEANER

€ 338,00

Herramienta especial para desatascar todo tipo de rotatorios y mangueras de turbinas.

- Trabaja con presiones hasta 40 bares.

- Completo con todos los accesorios:

\* Conexión Midwest 4 con luz para acoplamiento, turbinas, micromotores y otros.

\* Conector sistema INTRA para contra-ángulos y piezas de mano.

\* "Conector para mangueras de turbina!!!".

\* Accesorio para turbinas con varios orificios de spray.

*Nota a nuestros clientes: es posible que encuentren el Smart Cleaner más barato en algunos competidores. Por lo general, es porque NO incluyen el adaptador para mangueras de turbina. ¡Asegúrense de consultarlo antes!*



44-021

Anillo tórico pistón Smart Cleaner

€ 0,80