

JRJ

▶ JERINGAS Y REPUESTOS JERINGAS

- Jeringas **Luzzani** y sus repuestos
- Jeringas **FARO** y sus repuestos
- Jeringas económicas



RUMAR

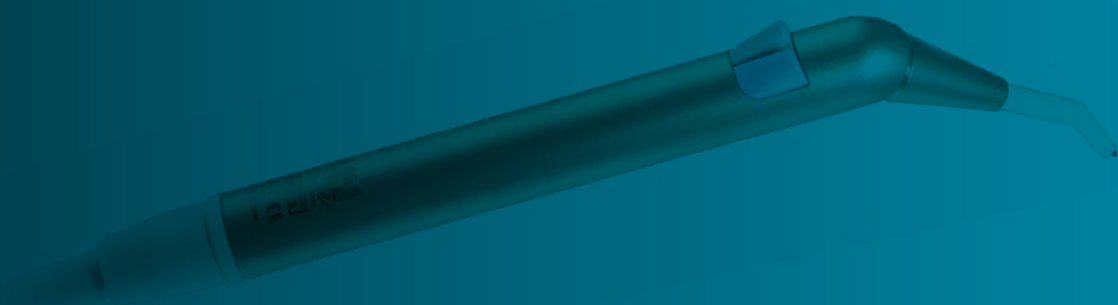
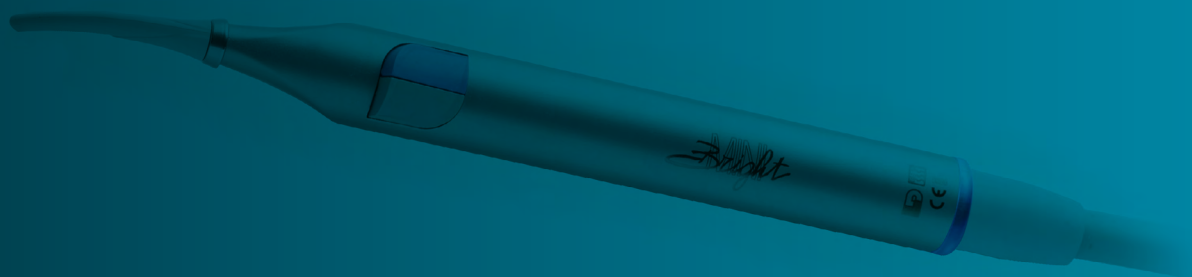



Consulta por las
puntas desechables
Pro-Tip TURBO

Jeringas Luzzani Minibright



Conexión Abierta / Open End

Características



Jeringa Minibright 6F
 Conexión equipo: Abierta

Longitud: 170cm
Forma: Recta
Color: Gris (RAL 7038)
Material: Acero







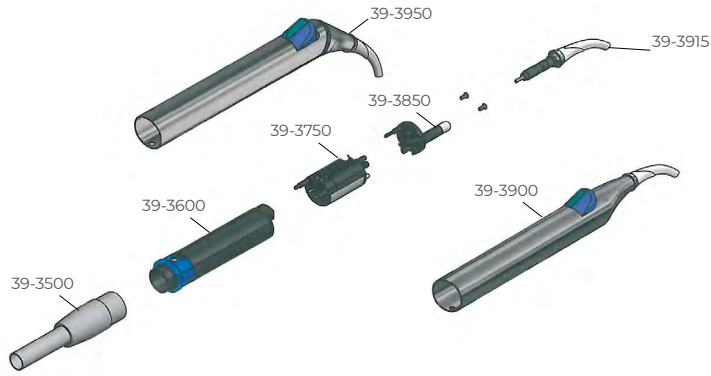

Ref.: 39-3151

TODOS LOS REPUESTOS JERINGAS LUZZANI CONSULTE PRECIOS Y DESPIECES

Consulta por las
puntas desechables
Pro-Tip TURBO



Repuestos Jeringas Minibright: F6 y EFFE 6 BEI

	Descripción	Características
	Punta jeringa Minibright Ref.: 39-3915	
	Kit completo reparación Minibright Ref.: 39-3000	
	Kit completo anillos tóricos Minibright Ref.: 39-3001	
	Cabeza completa Minibright Ref.: 39-3750	
	LED Minibright Ref.: 39-3850	
	Cuerpo central Minibright Ref.: 39-3600	
	Manguera completa Minibright Ref.: 39-3500	Longitud: 170cm Color: Gris (RAL 7038)
	Carcasa completa Minibright Ref.: 39-3900	





TODOS LOS REPUESTOS JERINGAS LUZZANI CONSULTE PRECIOS Y DESPIECES



Consulta por las
puntas desechables
Pro-Tip TURBO

Jeringas Luzzani Minilight: **Conexión Abierta / Open End**







Conexión Abierta / Open End		Características
	Jeringa Minilight 3F. Conexión equipo: Abierta Ref.: 39-12521	Longitud: 170cm Forma: Recta Color: Gris (RAL 7038) Material: Acero
	Jeringa Minilight 3F. Conexión equipo: Abierta Ref.: 39-12621	Longitud: 170cm Forma: Angulada Color: Gris (RAL 7038) Material: Acero
	Jeringa Minilight 3F. Conexión equipo: Abierta Ref.: 39-12523	Longitud: 170cm Forma: Recta Color: Negra Material: Acero
	Jeringa Minilight 6F. Conexión equipo: Abierta Ref.: 39-11521	Longitud: 170cm Forma: Recta Color: Gris (RAL 7038) Material: Acero
	Jeringa Minilight 6F. Conexión equipo: Abierta Ref.: 39-11621	Longitud: 170cm Forma: Angulada Color: Gris (RAL 7038) Material: Acero













HASTA AGOTAR

Jeringas Luzzani Minilight: **Conector a equipo Cefla® (Desde 2006)**









Conector a equipo Cefla® (desde 2006)		Descripción
 	Jeringa Minilight 3F. Conexión equipo Cefla® (desde 2006): Anthos®: A3, A5, A6, A7, A9, L6, L9, R7; Stern Weber®: S200, S220TR S250, S280TRC, S300, 320TR, S320TR, S380TRC; Castellini®: SKEMA 5, SKEMA 6, SKEMA 8 Ref.: 39-12521C1	Longitud: 120cm Forma: Recta Color: Gris (RAL 7038) Material: Acero
 	Jeringa Minilight 3F. Conexión equipo Cefla® (desde 2006): Anthos®: A3, A5, A6, A7, A9, L6, L9, R7; Stern Weber®: S200, S220TR S250, S280TRC, S300, 320TR, S320TR, S380TRC; Castellini®: SKEMA 5, SKEMA 6, SKEMA 8 Ref.: 39-12521C2	Longitud: 135cm Forma: Recta Color: Gris (RAL 7038) Material: Acero

TODOS LOS REPUESTOS JERINGAS LUZZANI CONSULTE PRECIOS Y DESPIECES

Conector a equipo Cefla® (desde 2006)		Descripción
	 <p>Jeringa Minilight 3F Conexión equipo Cefla® (desde 2006): Anthos®: A3, A5, A6, A7, A9, L6, L9, R7; Stern Weber®: S200, S220TR S250, S280TRC, S300, 320TR, S320TR, S380TRC; Castellini®: SKEMA 5, SKEMA 6, SKEMA 8</p> <p>Ref.: 39-12621C1</p>	<p>Longitud: 120cm Forma: Angulada Color: Gris (RAL 7038) Material: Acero</p>
	 <p>Jeringa Minilight 3F Conexión equipo Cefla® (desde 2006): Anthos®: A3, A5, A6, A7, A9, L6, L9, R7; Stern Weber®: S200, S220TR S250, S280TRC, S300, 320TR, S320TR, S380TRC; Castellini®: SKEMA 5, SKEMA 6, SKEMA 8</p> <p>Ref.: 39-12621C2</p>	<p>Longitud: 135cm Forma: Angulada Color: Gris (RAL 7038) Material: Acero</p>
	 <p>Jeringa Minilight 3F Conexión equipo Cefla® (desde 2006): Anthos®: A3, A5, A6, A7, A9, L6, L9, R7; Stern Weber®: S200, S220TR S250, S280TRC, S300, 320TR, S320TR, S380TRC; Castellini®: SKEMA 5, SKEMA 6, SKEMA 8</p> <p>Ref.: 39-11521C1</p>	<p>Longitud: 120cm Forma: Recta Color: Gris (RAL 7038) Material: Acero</p> <p style="text-align: right;">BAJO PEDIDO</p>
	 <p>Jeringa Minilight 3F Conexión equipo Cefla® (desde 2006): Anthos®: A3, A5, A6, A7, A9, L6, L9, R7; Stern Weber®: S200, S220TR S250, S280TRC, S300, 320TR, S320TR, S380TRC; Castellini®: SKEMA 5, SKEMA 6, SKEMA 8</p> <p>Ref.: 39-11521C2</p>	<p>Longitud: 135cm Forma: Recta Color: Gris (RAL 7038) Material: Acero</p> <p style="text-align: right;">BAJO PEDIDO</p>
	 <p>Jeringa Minilight 3F Conexión equipo Cefla® (desde 2006): Anthos®: A3, A5, A6, A7, A9, L6, L9, R7; Stern Weber®: S200, S220TR S250, S280TRC, S300, 320TR, S320TR, S380TRC; Castellini®: SKEMA 5, SKEMA 6, SKEMA 8</p> <p>Ref.: 39-11621C1</p>	<p>Longitud: 120cm Forma: Angulada Color: Gris (RAL 7038) Material: Acero</p> <p style="text-align: right;">BAJO PEDIDO</p>
	 <p>Jeringa Minilight 3F Conexión equipo Cefla® (desde 2006): Anthos®: A3, A5, A6, A7, A9, L6, L9, R7; Stern Weber®: S200, S220TR S250, S280TRC, S300, 320TR, S320TR, S380TRC; Castellini®: SKEMA 5, SKEMA 6, SKEMA 8</p> <p>Ref.: 39-11621C2</p>	<p>Longitud: 135cm Forma: Angulada Color: Gris (RAL 7038) Material: Acero</p> <p style="text-align: right;">BAJO PEDIDO</p>

Jeringas Luzzani Minilight: Conector a equipo KaVo®























Conector a equipo KaVo®		Descripción
	 <p>Jeringa Minilight 3F Conexión equipo: KaVo® 1057, 1058, 1060, 1062, 1063, 1065, 1066, 1078, 1080 (Series 1) **Excepto** 1058 Primus Life</p> <p>Ref.: 39-12521K1</p>	<p>Longitud: 120cm Forma: Recta Color: Gris (RAL 7038) Material: Acero</p>
	 <p>Jeringa Minilight 3F Conexión equipo: KaVo® 1057, 1058, 1060, 1062, 1063, 1065, 1066, 1078, 1080 (Series 1) **Excepto** 1058 Primus Life</p> <p>Ref.: 39-12521K2</p>	<p>Longitud: 135cm Forma: Recta Color: Gris (RAL 7038) Material: Acero</p>
	 <p>Jeringa Minilight 3F Conexión equipo: KaVo® E30, E50, E70, E80 y 1058 Primus Life (Serie 2)</p> <p>Ref.: 39-12521K3</p>	<p>Longitud: 120cm Forma: Recta Color: Gris (RAL 7038) Material: Acero</p>

TODOS LOS REPUESTOS JERINGAS LUZZANI CONSULTE PRECIOS Y DESPIECES

SI NO ENCUENTRAS EL ROTOR QUE BUCAS, ¡CONSÚLTANOS!

Conector a equipo KaVo®

Características

		Jeringa Minilight 3F Conexión equipo: KaVo® E30, E50, E70, E80 y 1058 Primus Life (Serie 2)	Longitud: 135cm Forma: Recta Color: Gris (RAL 7038) Material: Acero	Ref.: 39-12521K4	BAJO PEDIDO
		Jeringa Minilight 3F Conexión equipo: KaVo® 1057, 1058, 1060, 1062, 1063, 1065, 1066, 1078, 1080 (Series 1) **Excepto** 1058 Primus Life	Longitud: 120cm Forma: Angulada Color: Gris (RAL 7038) Material: Acero	Ref.: 39-12621K1	
		Jeringa Minilight 3F Conexión equipo: KaVo® 1057, 1058, 1060, 1062, 1063, 1065, 1066, 1078, 1080 (Series 1) **Excepto** 1058 Primus Life	Longitud: 120cm Forma: Angulada Color: Gris (RAL 7038) Material: Acero	Ref.: 39-12621K2	
		Jeringa Minilight 6F Conexión equipo: KaVo® 1057, 1058, 1060, 1062, 1063, 1065, 1066, 1078, 1080 (Series 1) **Excepto** 1058 Primus Life	Longitud: 135cm Forma: Recta Color: Gris (RAL 7038) Material: Acero	Ref.: 39-11521K1	BAJO PEDIDO
		Jeringa Minilight 6F Conexión equipo: KaVo® 1057, 1058, 1060, 1062, 1063, 1065, 1066, 1078, 1080 (Series 1) **Excepto** 1058 Primus Life	Longitud: 135cm Forma: Recta Color: Gris (RAL 7038) Material: Acero	Ref.: 39-11521K2	BAJO PEDIDO
		Jeringa Minilight 6F Conexión equipo: KaVo® 1057, 1058, 1060, 1062, 1063, 1065, 1066, 1078, 1080 (Series 1) **Excepto** 1058 Primus Life	Longitud: 120cm Forma: Angulada Color: Gris (RAL 7038) Material: Acero	Ref.: 39-11621K1	BAJO PEDIDO
		Jeringa Minilight 6F Conexión equipo: KaVo® 1057, 1058, 1060, 1062, 1063, 1065, 1066, 1078, 1080 (Series 1) **Excepto** 1058 Primus Life	Longitud: 135cm Forma: Angulada Color: Gris (RAL 7038) Material: Acero	Ref.: 39-11621K2	BAJO PEDIDO
		Jeringa Minilight 6F Conexión equipo: KaVo®, E30, E50, E70, E80, 1058 Primus Life (Serie 2)	Longitud: 120cm Forma: Recta Color: Gris (RAL 7038) Material: Acero	Ref.: 39-11521K3	BAJO PEDIDO
		Jeringa Minilight 6F Conexión equipo: KaVo®, E30, E50, E70, E80, 1058 Primus Life (Serie 2)	Longitud: 135cm Forma: Recta Color: Gris (RAL 7038) Material: Acero	Ref.: 39-11521K4	BAJO PEDIDO
		Jeringa Minilight 6F Conexión equipo: KaVo®, E30, E50, E70, E80, 1058 Primus Life (Serie 2)	Longitud: 120cm Forma: Angulada Color: Gris (RAL 7038) Material: Acero	Ref.: 39-11621K3	BAJO PEDIDO

TODOS LOS REPUESTOS JERINGAS LUZZANI CONSULTE PRECIOS Y DESPIECES

Conector a equipo KaVo®

Jeringa Minilight 6F

Conexión equipo: KaVo®, E30, E50, E70, E80, 1058 Primus Life (Serie 2)**Ref.:** 39-11621K4**Características****Longitud:** 135cm**Forma:** Angulada**Color:** Gris (RAL 7038)**Material:** Acero

BAJO PEDIDO



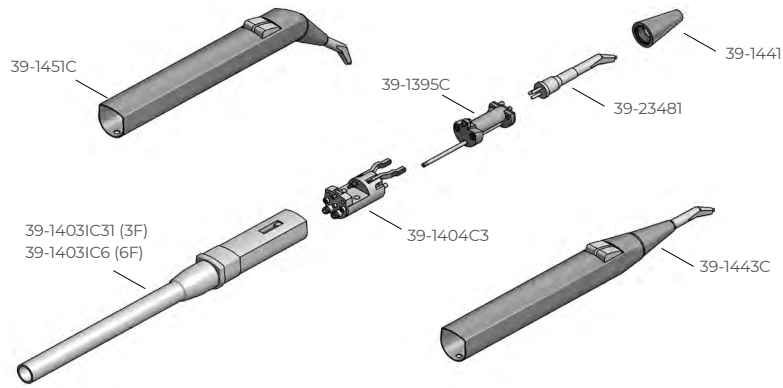





TODOS LOS REPUESTOS JERINGAS LUZZANI CONSULTE PRECIOS Y DESPIECES



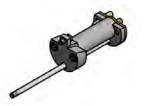



Consulta por las
puntas desechables
Pro-Tip TURBO



Repuestos Jeringas Minilight

	Descripción	Características
	Kit completo reparación Ref.: 39-1000	
	Kit completo 18 anillos tóricos Ref.: 39-1001	
	Cabeza completa 3F Ref.: 39-1395C	
	Manguera completa jeringa 3F Ref.: 39-14031C31	Longitud: 170cm Color: Gris (RAL 7038) Material jeringa: Acero
	Manguera completa jeringa 6F Ref.: 39-14031C6	Longitud: 170cm Color: Gris (RAL 7038) Material jeringa: Acero
	Cuerpo jeringa 3F (NO 6F) Ref.: 39-1404C3	
 <p>Imagen no disponible</p>	Cuerpo jeringa 6F Ref.: 39-1404	
	Cono Acero Ref.: 39-1441	

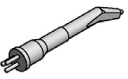
TODOS LOS REPUESTOS JERINGAS LUZZANI CONSULTE PRECIOS Y DESPIECES

	Descripción	Características
	<p>Carcasa completa recta Acero</p> <p>Ref.: 39-1443C</p>	
	<p>Carcasa completa angulada Acero</p> <p>Ref.: 39-1451C</p>	
	<p>Punta gris</p> <p>Ref.: 39-23481</p>	
	<p>Adaptador jeringas Minilight Tecnopolimero a Acero</p> <p>Ref.: 39-1400</p>	

TODOS LOS REPUESTOS JERINGAS LUZZANI CONSULTE PRECIOS Y DESPIECES

Consulta por las
puntas desechables



Pro-Tip TURBO



Jeringas Luzzani Minimate: **Conexión Abierta / Open End**

Conexión Abierta / Open End

Características

	<p>Jeringa Minimate 3F Conexión equipo: Abierta</p> <p>Ref.: 39-251</p>	<p>Longitud: 170cm Forma: Recta Color: Gris (RAL 7038) Material: Acero</p>
	<p>Jeringa Minimate 3F Conexión equipo: Abierta</p> <p>Ref.: 39-261</p>	<p>Longitud: 170cm Forma: Angulada Color: Gris (RAL 7038) Material: Acero</p>
	<p>Jeringa Minimate 3F Conexión equipo: Abierta</p> <p>Ref.: 39-2612</p>	<p>Longitud: 170cm Forma: Angulada Color: Negra Material: Acero</p>









HASTA AGOTAR

Jeringas Luzzani Minimate: **Conector a equipo Cefla® (desde 2006)**



Conector a equipo Cefla® desde 2006

Descripción

 	<p>Jeringa Minimate 3F Conexión equipo Cefla® (desde 2006): Anthos®: A3, A5, A6, A7, A9, L6, L9, R7; Stern Weber®: S200, S220TR S250, S280TRC, S300, 320TR, S320TR, S380TRC; Castellini®: SKEMA 5, SKEMA 6, SKEMA 8</p> <p>Ref.: 39-251C1</p>	<p>Longitud: 120cm Forma: Recta Color: Gris (RAL 7038) Material: Acero</p>
 	<p>Jeringa Minimate 3F Conexión equipo Cefla® (desde 2006): Anthos®: A3, A5, A6, A7, A9, L6, L9, R7; Stern Weber®: S200, S220TR S250, S280TRC, S300, 320TR, S320TR, S380TRC; Castellini®: SKEMA 5, SKEMA 6, SKEMA 8</p> <p>Ref.: 39-251C2</p>	<p>Longitud: 135cm Forma: Recta Color: Gris (RAL 7038) Material: Acero</p>
 	<p>Jeringa Minimate 3F Conexión equipo Cefla® (desde 2006): Anthos®: A3, A5, A6, A7, A9, L6, L9, R7; Stern Weber®: S200, S220TR S250, S280TRC, S300, 320TR, S320TR, S380TRC; Castellini®: SKEMA 5, SKEMA 6, SKEMA 8</p> <p>Ref.: 39-261C1</p>	<p>Longitud: 120cm Forma: Angulada Color: Gris (RAL 7038) Material: Acero</p>
 	<p>Jeringa Minimate 3F Conexión equipo Cefla® (desde 2006): Anthos®: A3, A5, A6, A7, A9, L6, L9, R7; Stern Weber®: S200, S220TR S250, S280TRC, S300, 320TR, S320TR, S380TRC; Castellini®: SKEMA 5, SKEMA 6, SKEMA 8</p> <p>Ref.: 39-261C2</p>	<p>Longitud: 135cm Forma: Angulada Color: Gris (RAL 7038) Material: Acero</p>

TODOS LOS REPUESTOS JERINGAS LUZZANI CONSULTE PRECIOS Y DESPIECES

Jeringas Luzzani Minimate: **Conector a equipo KaVo®**

Conexión Abierta / Open End		Características
	<p>Jeringa Minimate 3F Conexión equipo: KaVo® 1057, 1058, 1060, 1062, 1063, 1065, 1066, 1078, 1080 (Series 1) **Excepto** 1058 Primus Life</p> <p>Ref.: 39-251K1</p>	<p>Longitud: 120cm Forma: Recta Color: Gris (RAL 7038) Material: Acero</p>
	<p>Jeringa Minimate 3F Conexión equipo: KaVo® 1057, 1058, 1060, 1062, 1063, 1065, 1066, 1078, 1080 (Series 1) **Excepto** 1058 Primus Life</p> <p>Ref.: 39-251K2</p>	<p>Longitud: 135cm Forma: Recta Color: Gris (RAL 7038) Material: Acero</p>
	<p>Jeringa Minimate 3F Conexión equipo: KaVo®, E30, E50, E70, E80, 1058 Primus Life (Serie 2)</p> <p>Ref.: 39-251K3</p>	<p>Longitud: 120cm Forma: Recta Color: Gris (RAL 7038) Material: Acero</p>
	<p>Jeringa Minimate 3F Conexión equipo: KaVo®, E30, E50, E70, E80, 1058 Primus Life (Serie 2)</p> <p>Ref.: 39-251K4</p>	<p>Longitud: 135cm Forma: Recta Color: Gris (RAL 7038) Material: Acero</p> <p style="text-align: right;">BAJO PEDIDO</p>
	<p>Jeringa Minimate 3F Conexión equipo: KaVo® 1057, 1058, 1060, 1062, 1063, 1065, 1066, 1078, 1080 (Series 1) **Excepto** 1058 Primus Life</p> <p>Ref.: 39-261K1</p>	<p>Longitud: 120cm Forma: Angulada Color: Gris (RAL 7038) Material: Acero</p>
	<p>Jeringa Minimate 3F Conexión equipo: KaVo® 1057, 1058, 1060, 1062, 1063, 1065, 1066, 1078, 1080 (Series 1) **Excepto** 1058 Primus Life</p> <p>Ref.: 39-261K2</p>	<p>Longitud: 135cm Forma: Angulada Color: Gris (RAL 7038) Material: Acero</p>

Jeringas Luzzani Miniassistant

Conexión Abierta / Open End	Descripción
<p>Jeringa Miniassistant 3F Conexión equipo: Abierta</p> <p>Ref.: 39-0621</p>	<p>Longitud: 170cm Forma: Angulada Color: Gris (RAL 7038) Material: Acero</p>





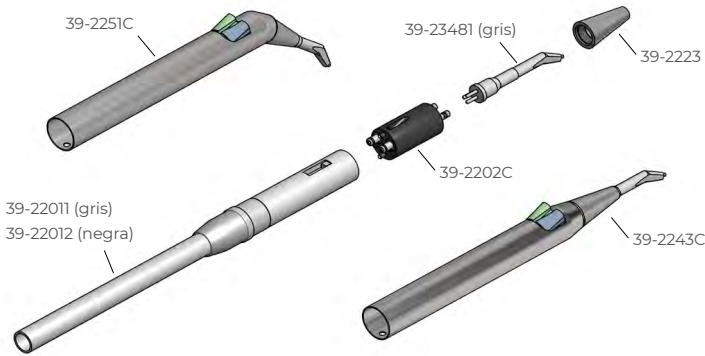

TODOS LOS REPUESTOS JERINGAS LUZZANI CONSULTE PRECIOS Y DESPIECES

Consulta por las
puntas desechables
Pro-Tip TURBO



Repuestos Jeringas Minimate

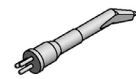

	Descripción	Características
	Kit completo reparación Ref.: 39-2000	
	Manguera completa para jeringa 3F Ref.: 39-22011	Longitud: 170cm Color: Gris (RAL 7038) Material jeringa: Acero
	Manguera completa para jeringa 3F Ref.: 39-22012	Longitud: 170cm Color: Negra Material jeringa: Acero HASTA AGOTAR
	Cuerpo jeringa 3F Ref.: 39-2202C	
	Cono Acero Origen: Italia Fabricante: Luzzani Dental S.R.L. Garantía: 12 meses Ref.: 39-2223	
	Carcasa completa recta Acero Ref.: 39-2243C	Forma: Recta Material: Acero
	Carcasa completa angulada Acero Ref.: 39-2251C	Forma: Angulada Material: Acero
	Punta gris Ref.: 39-23481	

TODOS LOS REPUESTOS JERINGAS LUZZANI CONSULTE PRECIOS Y DESPIECES

Consulta por las
puntas desechables
Pro-Tip TURBO

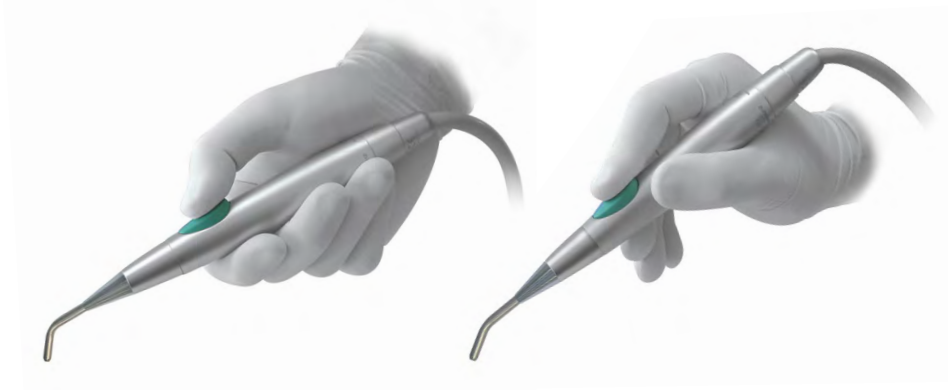

Jeringas Faro SYR3



Conexión Abierta / Open End

Características

	<p>Jeringa Faro SYR3 Conexión equipo: Abierta</p> <p>Ref.: 80-500101 (Ref. Faro: 094000101)</p>	<p>Forma: Angulada Color: Gris (RAL 7038) Material: Acero</p>
	<p>Jeringa Faro SYR3 Conexión equipo: Abierta</p> <p>Ref.: 80-500100 (Ref. Faro: 094000100)</p>	<p>Forma: Recta Color: Gris (RAL 7038) Material: Acero</p>

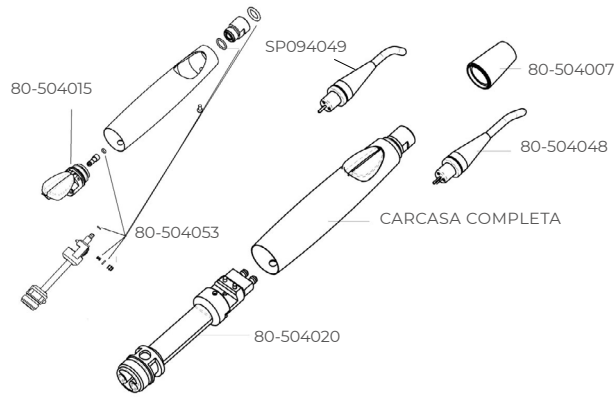

TODOS LOS REPUESTOS FARO CONSULTE PRECIOS Y DESPIECES



Consulta por las
puntas desechables
Pro-Tip TURBO

Repuestos Jeringas Faro SYR3

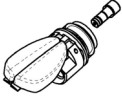
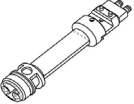
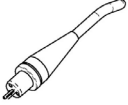

	Descripción	Características
	Cono acero Ref.: 80-504007 (Ref. Faro: SP094007)	
	Botonera aire/agua jeringa (luds) Ref.: 80-504015 (Ref. Faro: SP094015 /3)	
	Cuerpo jeringa Ref.: 80-504020 (Ref. Faro: SP094020)	
	Punta recta gris jeringa Ref.: 80-504048 (Ref. Faro: SP094048)	
 Imagen no disponible Ver despiece	Kit completo reparación jeringa Ref.: 80-504053 (Ref. Faro: SP094053)	

Repuestos Jeringas Faro SM3

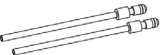

	Descripción	Características
	Medios aire/agua Ref.: 80-501291 (Ref. Faro: SP091291)	

TODOS LOS REPUESTOS FARO CONSULTE PRECIOS Y DESPIECES

Jeringas de acero económicas

RUMAR

	Descripción	Características
	<p>Jeringa de acero, 3F angulada (No manguera)*</p> <p>Ref.: 44-280</p>	
	<p>Jeringa de acero, 3F recta (No manguera)*</p> <p>Ref.: 44-281</p>	
	<p>Cánulas de repuesto, esterilizables</p> <p>Ref.: 44-285</p>	

*Ver manguera REF. 40-61A2000