

RUMAR

JRJ

▶ JERINGAS Y REPUESTOS JERINGAS

- Jeringas **Luzzani**® y sus repuestos
- Jeringas **FARO**® y sus repuestos
- Jeringas económicas
- Puntas compatibles jeringas



RUMAR

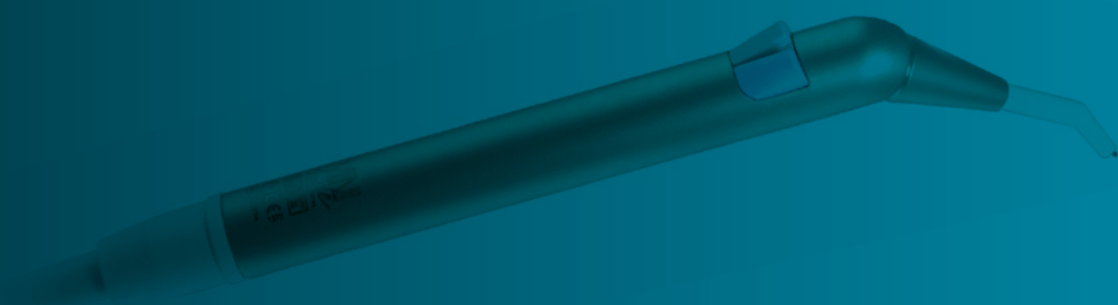
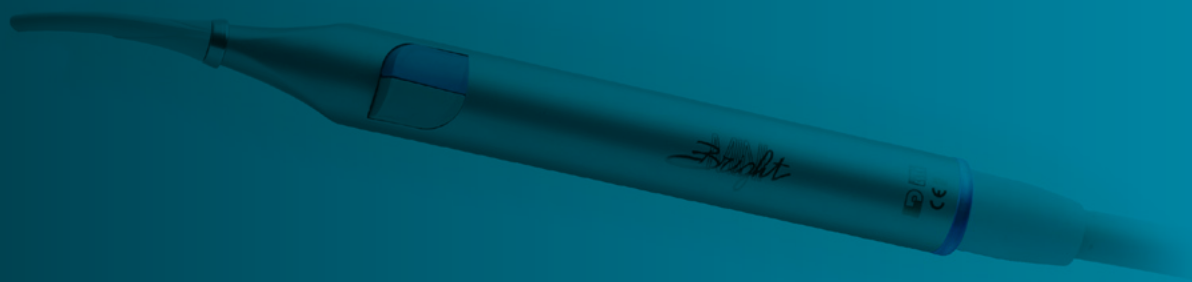



Consulta por las
puntas desechables
Pro-Tip TURBO

Jeringas Luzzani® Minibright



Conexión Abierta / Open End

Características



Jeringa Minibright 6F con luz
Conexión equipo: Abierta

Longitud: 170cm
Forma: Recta
Color: Gris (RAL 7038)
Material: Acero





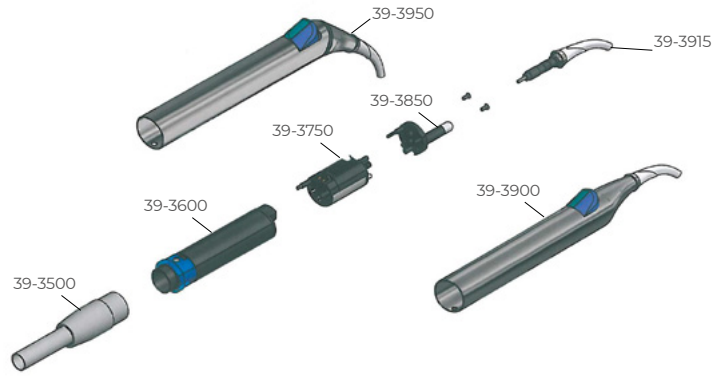

Ref.: 39-3151

TODOS LOS REPUESTOS JERINGAS LUZZANI® CONSULTE PRECIOS Y DESPIECES

Consulta por las
puntas desechables
Pro-Tip TURBO

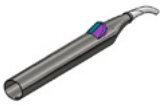

Repuestos Jeringas Minibrigh: F6 y EFFE 6 BEI

	Descripción	Características
	Punta jeringa Minibrigh Ref.: 39-3915	
	Kit completo reparación Minibrigh Ref.: 39-3000	
	Kit completo anillos tóricos Minibrigh Ref.: 39-3001	
	Cabeza completa Minibrigh Ref.: 39-3750	
	LED Minibrigh Ref.: 39-3850	
	Cuerpo central Minibrigh Ref.: 39-3600	
	Manguera completa Minibrigh Ref.: 39-3500	Longitud: 170cm Color: Gris (RAL 7038)
	Carcasa completa Minibrigh Ref.: 39-3900	

TODOS LOS REPUESTOS JERINGAS LUZZANI® CONSULTE PRECIOS Y DESPIECES





SI NO ENCUENTRAS EL REPUESTO QUE BUSCAS, ¡CONSÚLTANOS!



Consulta por las
puntas desechables
Pro-Tip^{TURBO}

Jeringas Luzzani® Minilight: Conexión Abierta / Open End



Conexión Abierta / Open End		Características
	Jeringa Minilight 3F. Conexión equipo: Abierta Ref.: 39-12521	Longitud: 170cm Forma: Recta Color: Gris (RAL 7038) Material: Acero
	Jeringa Minilight 3F. Conexión equipo: Abierta Ref.: 39-12621	Longitud: 170cm Forma: Angulada Color: Gris (RAL 7038) Material: Acero
	Jeringa Minilight 6F. Conexión equipo: Abierta Ref.: 39-11521	Longitud: 170cm Forma: Recta Color: Gris (RAL 7038) Material: Acero
	Jeringa Minilight 6F. Conexión equipo: Abierta Ref.: 39-11621	Longitud: 170cm Forma: Angulada Color: Gris (RAL 7038) Material: Acero











Jeringas Luzzani® Minilight: Conector a equipo Cefla® (Desde 2006)



Conector a equipo Cefla® (desde 2006)		Descripción
 	Jeringa Minilight 3F Conexión equipo Cefla® (desde 2006): Anthos®: A3, A5, A6, A7, A9, L6, L9, R7; Stern Weber®: S200, S220TR S250, S280TRC, S300, 320TR, S320TR, S380TRC; Castellini®: SKEMA 5, SKEMA 6, SKEMA 8 Ref.: 39-12521C1	Longitud: 120cm Forma: Recta Color: Gris (RAL 7038) Material: Acero
 	Jeringa Minilight 3F Conexión equipo Cefla® (desde 2006): Anthos®: A3, A5, A6, A7, A9, L6, L9, R7; Stern Weber®: S200, S220TR S250, S280TRC, S300, 320TR, S320TR, S380TRC; Castellini®: SKEMA 5, SKEMA 6, SKEMA 8 Ref.: 39-12521C2	Longitud: 135cm Forma: Recta Color: Gris (RAL 7038) Material: Acero
 	Jeringa Minilight 3F Conexión equipo Cefla® (desde 2006): Anthos®: A3, A5, A6, A7, A9, L6, L9, R7; Stern Weber®: S200, S220TR S250, S280TRC, S300, 320TR, S320TR, S380TRC; Castellini®: SKEMA 5, SKEMA 6, SKEMA 8 Ref.: 39-12621C1	Longitud: 120cm Forma: Angulada Color: Gris (RAL 7038) Material: Acero

TODOS LOS REPUESTOS JERINGAS LUZZANI® CONSULTE PRECIOS Y DESPIECES









Conector a equipo Cefla® (desde 2006)

		Descripción
	 <p>Jeringa Minilight 3F Conexión equipo Cefla® (desde 2006): Anthos®: A3, A5, A6, A7, A9, L6, L9, R7; Stern Weber®: S200, S220TR S250, S280TRC, S300, 320TR, S320TR, S380TRC; Castellini®: SKEMA 5, SKEMA 6, SKEMA 8</p> <p>Ref.: 39-12621C2</p>	<p>Longitud: 135cm Forma: Angulada Color: Gris (RAL 7038) Material: Acero</p>
	 <p>Jeringa Minilight 6F Conexión equipo Cefla® (desde 2006): Anthos®: A3, A5, A6, A7, A9, L6, L9, R7; Stern Weber®: S200, S220TR S250, S280TRC, S300, 320TR, S320TR, S380TRC; Castellini®: SKEMA 5, SKEMA 6, SKEMA 8</p> <p>Ref.: 39-11521C1</p>	<p>Longitud: 120cm Forma: Recta Color: Gris (RAL 7038) Material: Acero</p> <p style="text-align: right;">BAJO PEDIDO</p>
	 <p>Jeringa Minilight 6F Conexión equipo Cefla® (desde 2006): Anthos®: A3, A5, A6, A7, A9, L6, L9, R7; Stern Weber®: S200, S220TR S250, S280TRC, S300, 320TR, S320TR, S380TRC; Castellini®: SKEMA 5, SKEMA 6, SKEMA 8</p> <p>Ref.: 39-11521C2</p>	<p>Longitud: 135cm Forma: Recta Color: Gris (RAL 7038) Material: Acero</p> <p style="text-align: right;">BAJO PEDIDO</p>
	 <p>Jeringa Minilight 6F Conexión equipo Cefla® (desde 2006): Anthos®: A3, A5, A6, A7, A9, L6, L9, R7; Stern Weber®: S200, S220TR S250, S280TRC, S300, 320TR, S320TR, S380TRC; Castellini®: SKEMA 5, SKEMA 6, SKEMA 8</p> <p>Ref.: 39-11621C1</p>	<p>Longitud: 120cm Forma: Angulada Color: Gris (RAL 7038) Material: Acero</p> <p style="text-align: right;">BAJO PEDIDO</p>
	 <p>Jeringa Minilight 6F Conexión equipo Cefla® (desde 2006): Anthos®: A3, A5, A6, A7, A9, L6, L9, R7; Stern Weber®: S200, S220TR S250, S280TRC, S300, 320TR, S320TR, S380TRC; Castellini®: SKEMA 5, SKEMA 6, SKEMA 8</p> <p>Ref.: 39-11621C2</p>	<p>Longitud: 135cm Forma: Angulada Color: Gris (RAL 7038) Material: Acero</p> <p style="text-align: right;">BAJO PEDIDO</p>

Jeringas Luzzani® Minilight: Conector a equipo KaVo®



Conector a equipo KaVo®





















		Descripción
	 <p>Jeringa Minilight 3F Conexión equipo: KaVo® 1057, 1058, 1060, 1062, 1063, 1065, 1066, 1078, 1080 (Series 1) **Excepto** 1058 Primus Life</p> <p>Ref.: 39-12521K1</p>	<p>Longitud: 120cm Forma: Recta Color: Gris (RAL 7038) Material: Acero</p>
	 <p>Jeringa Minilight 3F Conexión equipo: KaVo® 1057, 1058, 1060, 1062, 1063, 1065, 1066, 1078, 1080 (Series 1) **Excepto** 1058 Primus Life</p> <p>Ref.: 39-12521K2</p>	<p>Longitud: 135cm Forma: Recta Color: Gris (RAL 7038) Material: Acero</p>
	 <p>Jeringa Minilight 3F Conexión equipo: KaVo® E30, E50, E70, E80 y 1058 Primus Life (Serie 2)</p> <p>Ref.: 39-12521K3</p>	<p>Longitud: 120cm Forma: Recta Color: Gris (RAL 7038) Material: Acero</p>
	 <p>Jeringa Minilight 3F Conexión equipo: KaVo® E30, E50, E70, E80 y 1058 Primus Life (Serie 2)</p> <p>Ref.: 39-12521K4</p>	<p>Longitud: 135cm Forma: Recta Color: Gris (RAL 7038) Material: Acero</p>

TODOS LOS REPUESTOS JERINGAS LUZZANI® CONSULTE PRECIOS Y DESPIECES

SI NO ENCUENTRAS EL REPUESTO QUE BUCAS, ¡CONSÚLTANOS!

Conector a equipo KaVo®

Características

 	<p>Jeringa Minilight 3F Conexión equipo: KaVo® 1057, 1058, 1060, 1062, 1063, 1065, 1066, 1078, 1080 (Series 1) **Excepto** 1058 Primus Life</p> <p>Ref.: 39-12621K1</p>	<p>Longitud: 120cm Forma: Angulada Color: Gris (RAL 7038) Material: Acero</p>
 	<p>Jeringa Minilight 3F Conexión equipo: KaVo® 1057, 1058, 1060, 1062, 1063, 1065, 1066, 1078, 1080 (Series 1) **Excepto** 1058 Primus Life</p> <p>Ref.: 39-12621K2</p>	<p>Longitud: 135cm Forma: Angulada Color: Gris (RAL 7038) Material: Acero</p>
 	<p>Jeringa Minilight 6F Conexión equipo: KaVo® 1057, 1058, 1060, 1062, 1063, 1065, 1066, 1078, 1080 (Series 1) **Excepto** 1058 Primus Life</p> <p>Ref.: 39-11521K1</p>	<p>Longitud: 120cm Forma: Recta Color: Gris (RAL 7038) Material: Acero</p> <p style="text-align: right;">BAJO PEDIDO</p>
 	<p>Jeringa Minilight 6F Conexión equipo: KaVo® 1057, 1058, 1060, 1062, 1063, 1065, 1066, 1078, 1080 (Series 1) **Excepto** 1058 Primus Life</p> <p>Ref.: 39-11521K2</p>	<p>Longitud: 135cm Forma: Recta Color: Gris (RAL 7038) Material: Acero</p> <p style="text-align: right;">BAJO PEDIDO</p>
 	<p>Jeringa Minilight 6F Conexión equipo: KaVo® 1057, 1058, 1060, 1062, 1063, 1065, 1066, 1078, 1080 (Series 1) **Excepto** 1058 Primus Life</p> <p>Ref.: 39-11621K1</p>	<p>Longitud: 120cm Forma: Angulada Color: Gris (RAL 7038) Material: Acero</p> <p style="text-align: right;">BAJO PEDIDO</p>
 	<p>Jeringa Minilight 6F Conexión equipo: KaVo® 1057, 1058, 1060, 1062, 1063, 1065, 1066, 1078, 1080 (Series 1) **Excepto** 1058 Primus Life</p> <p>Ref.: 39-11621K2</p>	<p>Longitud: 135cm Forma: Angulada Color: Gris (RAL 7038) Material: Acero</p> <p style="text-align: right;">BAJO PEDIDO</p>
 	<p>Jeringa Minilight 6F Conexión equipo: KaVo®, E30, E50, E70, E80, 1058 Primus Life (Serie 2)</p> <p>Ref.: 39-11521K3</p>	<p>Longitud: 120cm Forma: Recta Color: Gris (RAL 7038) Material: Acero</p> <p style="text-align: right;">BAJO PEDIDO</p>
 	<p>Jeringa Minilight 6F Conexión equipo: KaVo®, E30, E50, E70, E80, 1058 Primus Life (Serie 2)</p> <p>Ref.: 39-11521K4</p>	<p>Longitud: 135cm Forma: Recta Color: Gris (RAL 7038) Material: Acero</p> <p style="text-align: right;">BAJO PEDIDO</p>
 	<p>Jeringa Minilight 6F Conexión equipo: KaVo®, E30, E50, E70, E80, 1058 Primus Life (Serie 2)</p> <p>Ref.: 39-11621K3</p>	<p>Longitud: 120cm Forma: Angulada Color: Gris (RAL 7038) Material: Acero</p> <p style="text-align: right;">BAJO PEDIDO</p>
 	<p>Jeringa Minilight 6F Conexión equipo: KaVo®, E30, E50, E70, E80, 1058 Primus Life (Serie 2)</p> <p>Ref.: 39-11621K4</p>	<p>Longitud: 135cm Forma: Angulada Color: Gris (RAL 7038) Material: Acero</p> <p style="text-align: right;">BAJO PEDIDO</p>

TODOS LOS REPUESTOS JERINGAS LUZZANI® CONSULTE PRECIOS Y DESPIECES

Jeringas Luzzani® Minilight: **Conector a equipo Planmeca®**



Conector a equipo Planmeca®

Características

NUEVO



Jeringa Minilight 3F
Conexión equipo: Planmeca®

Ref.: 39-12521P1

Longitud: 100cm
Forma: Recta
Color: Gris claro (RAL 9002)
Material: Acero
Resistencia: 1.780 Ohm

NUEVO



Jeringa Minilight 3F
Conexión equipo: Planmeca®

Ref.: 39-12621P1

Longitud: 100cm
Forma: Angulada
Color: Gris claro (RAL 9002)
Material: Acero
Resistencia: 1.780 Ohm

BAJO PEDIDO

NUEVO



Jeringa Minilight 6F
Conexión equipo: Planmeca®

Ref.: 39-11521P1 (Ref. Planmeca®: 52600287-20)

Longitud: 100cm
Forma: Recta
Color: Gris claro (RAL9002)
Material: Acero
Resistencia: 1.780 Ohm

BAJO PEDIDO

NUEVO



Jeringa Minilight 6F
Conexión equipo: Planmeca®

Ref.: 39-11621P1

Longitud: 100cm
Forma: Angulada
Color: Gris real (RAL 9002)
Material: Acero
Resistencia: 1.780 Ohm

BAJO PEDIDO

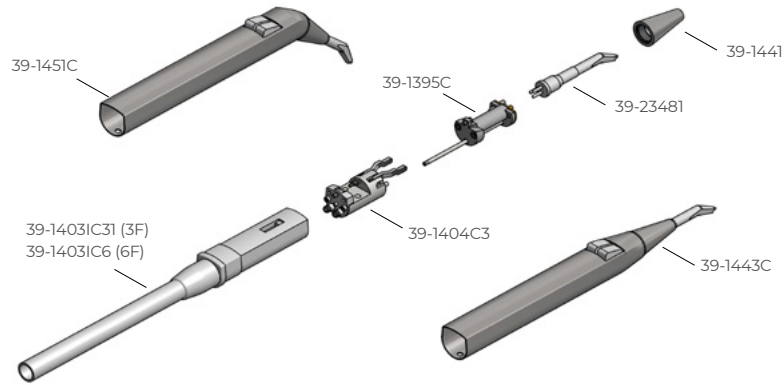

Consulta por las
 puntas desechables

Pro-Tip TURBO

Repuestos Jeringas Minilight



Descripción

Características



Kit completo reparación

Ref.: 39-1000











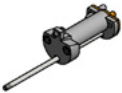

Kit completo 18 anillos tóricos

Ref.: 39-1001

TODOS LOS REPUESTOS JERINGAS LUZZANI® CONSULTE PRECIOS Y DESPIECES

SI NO ENCUENTRAS EL REPUESTO QUE BUCAS, ¡CONSÚLTANOS!

	Descripción	Características
	Cabeza completa 3F Ref.: 39-1395C	
	Manguera completa jeringa 3F Ref.: 39-14031C31	Longitud: 170cm Color: Gris (RAL 7038) Material jeringa: Acero
	Manguera completa jeringa 6F Ref.: 39-14031C6	Longitud: 170cm Color: Gris (RAL 7038) Material jeringa: Acero
	Cuerpo jeringa 3F (NO 6F) Ref.: 39-1404C3	
 <small>Imagen no disponible</small>	Cuerpo jeringa 6F Ref.: 39-1404	
	Cono Acero Ref.: 39-1441	
	Carcasa completa recta Acero Ref.: 39-1443C	
	Carcasa completa angulada Acero Ref.: 39-1451C	
	Punta gris Ref.: 39-23481	
	Adaptador jeringas Minilight Tecnopolimero a Acero Ref.: 39-1400	

TODOS LOS REPUESTOS JERINGAS LUZZANI® CONSULTE PRECIOS Y DESPIECES

Consulta por las
puntas desechables



Pro-Tip TURBO



Jeringas Luzzani® Minimate: **Conexión Abierta / Open End**

Conexión Abierta / Open End

Características









	<p>Jeringa Minimate 3F Conexión equipo: Abierta</p> <p>Ref.: 39-251</p>	<p>Longitud: 170cm Forma: Recta Color: Gris (RAL 7038) Material: Acero</p>
	<p>Jeringa Minimate 3F Conexión equipo: Abierta</p> <p>Ref.: 39-261</p>	<p>Longitud: 170cm Forma: Angulada Color: Gris (RAL 7038) Material: Acero</p>

Jeringas Luzzani® Minimate: **Conector a equipo Cefla® (desde 2006)**



Conector a equipo Cefla® desde 2006

Descripción

 	<p>Jeringa Minimate 3F Conexión equipo Cefla® (desde 2006): Anthos®: A3, A5, A6, A7, A9, L6, L9, R7; Stern Weber®: S200, S220TR S250, S280TRC, S300, 320TR, S320TR, S380TRC; Castellini®: SKEMA 5, SKEMA 6, SKEMA 8</p> <p>Ref.: 39-251C1</p>	<p>Longitud: 120cm Forma: Recta Color: Gris (RAL 7038) Material: Acero</p>
 	<p>Jeringa Minimate 3F Conexión equipo Cefla® (desde 2006): Anthos®: A3, A5, A6, A7, A9, L6, L9, R7; Stern Weber®: S200, S220TR S250, S280TRC, S300, 320TR, S320TR, S380TRC; Castellini®: SKEMA 5, SKEMA 6, SKEMA 8</p> <p>Ref.: 39-251C2</p>	<p>Longitud: 135cm Forma: Recta Color: Gris (RAL 7038) Material: Acero</p>
 	<p>Jeringa Minimate 3F Conexión equipo Cefla® (desde 2006): Anthos®: A3, A5, A6, A7, A9, L6, L9, R7; Stern Weber®: S200, S220TR S250, S280TRC, S300, 320TR, S320TR, S380TRC; Castellini®: SKEMA 5, SKEMA 6, SKEMA 8</p> <p>Ref.: 39-261C1</p>	<p>Longitud: 120cm Forma: Angulada Color: Gris (RAL 7038) Material: Acero</p>
 	<p>Jeringa Minimate 3F Conexión equipo Cefla® (desde 2006): Anthos®: A3, A5, A6, A7, A9, L6, L9, R7; Stern Weber®: S200, S220TR S250, S280TRC, S300, 320TR, S320TR, S380TRC; Castellini®: SKEMA 5, SKEMA 6, SKEMA 8</p> <p>Ref.: 39-261C2</p>	<p>Longitud: 135cm Forma: Angulada Color: Gris (RAL 7038) Material: Acero</p>















TODOS LOS REPUESTOS JERINGAS LUZZANI® CONSULTE PRECIOS Y DESPIECES

SI NO ENCUENTRAS EL REPUESTO QUE BUCAS, ¡CONSÚLTANOS!

Jeringas Luzzani® Minimate: **Conector a equipo KaVo®**

Conexión a equipo KaVo®

Características





 	<p>Jeringa Minimate 3F Conexión equipo: KaVo® 1057, 1058, 1060, 1062, 1063, 1065, 1066, 1078, 1080 (Series 1) **Excepto** 1058 Primus Life</p> <p>Ref.: 39-251K1</p>	<p>Longitud: 120cm Forma: Recta Color: Gris (RAL 7038) Material: Acero</p>
 	<p>Jeringa Minimate 3F Conexión equipo: KaVo® 1057, 1058, 1060, 1062, 1063, 1065, 1066, 1078, 1080 (Series 1) **Excepto** 1058 Primus Life</p> <p>Ref.: 39-251K2</p>	<p>Longitud: 135cm Forma: Recta Color: Gris (RAL 7038) Material: Acero</p>
 	<p>Jeringa Minimate 3F Conexión equipo: KaVo®, E30, E50, E70, E80, 1058 Primus Life (Serie 2)</p> <p>Ref.: 39-251K3</p>	<p>Longitud: 120cm Forma: Recta Color: Gris (RAL 7038) Material: Acero</p>
 	<p>Jeringa Minimate 3F Conexión equipo: KaVo®, E30, E50, E70, E80, 1058 Primus Life (Serie 2)</p> <p>Ref.: 39-251K4</p>	<p>Longitud: 135cm Forma: Recta Color: Gris (RAL 7038) Material: Acero</p> <p style="text-align: right;">BAJO PEDIDO</p>
 	<p>Jeringa Minimate 3F Conexión equipo: KaVo® 1057, 1058, 1060, 1062, 1063, 1065, 1066, 1078, 1080 (Series 1) **Excepto** 1058 Primus Life</p> <p>Ref.: 39-261K1</p>	<p>Longitud: 120cm Forma: Angulada Color: Gris (RAL 7038) Material: Acero</p>
 	<p>Jeringa Minimate 3F Conexión equipo: KaVo® 1057, 1058, 1060, 1062, 1063, 1065, 1066, 1078, 1080 (Series 1) **Excepto** 1058 Primus Life</p> <p>Ref.: 39-261K2</p>	<p>Longitud: 135cm Forma: Angulada Color: Gris (RAL 7038) Material: Acero</p>
 	<p>Jeringa Minimate 3F Conexión equipo: KaVo®, E30, E50, E70, E80, 1058 Primus Life (Serie 2)</p> <p>Ref.: 39-261K3</p>	<p>Longitud: 120cm Forma: Angulada Color: Gris (RAL 7038) Material: Acero</p>

NUEVO

Jeringas Luzzani® Minimate: **Conector a equipo Planmeca®**

Conexión a equipo Planmeca®

Descripción

 	<p>Jeringa Miniassistant 3F Conexión equipo: Planmeca®</p> <p>Ref.: 39-251P1</p>	<p>Longitud: 100cm Forma: Recta Color: Gris real (RAL 9002) Material: Acero Resistencia: 1.780 Ohm</p>
 	<p>Jeringa Miniassistant 3F Conexión equipo: Planmeca®</p> <p>Ref.: 39-261P1</p>	<p>Longitud: 100cm Forma: Angulada Color: Gris real (RAL 9002) Material: Acero Resistencia: 1.780 Ohm</p> <p style="text-align: right;">BAJO PEDIDO</p>

NUEVO

NUEVO

TODOS LOS REPUESTOS JERINGAS LUZZANI® CONSULTE PRECIOS Y DESPIECES

Jeringas Luzzani® Miniassistant



Conexión Abierta / Open End

Descripción



Jeringa Miniassistant 3F
Conexión equipo: Abierta

Longitud: 170cm
Forma: Angulada
Color: Gris (RAL 7038)
Material: Acero

Ref.: 39-0621

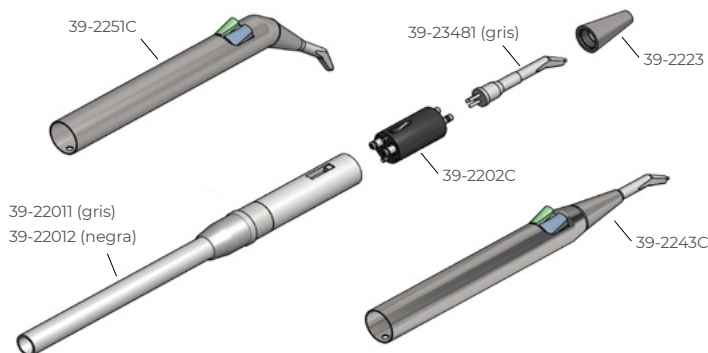

Consulta por las
puntas desechables
Pro-Tip TURBO

Repuestos Jeringas Minimate



Descripción

Características



Kit completo reparación

Ref.: 39-2000



Manguera completa para jeringa 3F

Ref.: 39-22011

Longitud: 170cm
Color: Gris (RAL 7038)
Material jeringa: Acero



Manguera completa para jeringa 3F

Ref.: 39-22012

Longitud: 170cm
Color: Negra
Material jeringa: Acero

HASTA AGOTAR



Cuerpo jeringa 3F

Ref.: 39-2202C



Cono Acero

Origen: Italia **Fabricante:** Luzzani® Dental S.R.L. **Garantía:** 12 meses

Ref.: 39-2223

TODOS LOS REPUESTOS JERINGAS LUZZANI® CONSULTE PRECIOS Y DESPIECES

SI NO ENCUENTRAS EL REPUESTO QUE BUCAS, ¡CONSÚLTANOS!

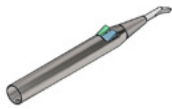
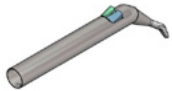
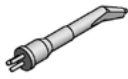
	Descripción	Características
	Carcasa completa recta Acero Ref.: 39-2243C	Forma: Recta Material: Acero
	Carcasa completa angulada Acero Ref.: 39-2251C	Forma: Angulada Material: Acero
	Punta gris Ref.: 39-23481	

Consulta por las
puntas desechables
Pro-Tip^{TURBO}



Jeringas Faro® SYR3



Conexión Abierta / Open End

Características

	Jeringa Faro SYR3 Conexión equipo: Abierta Ref.: 80-500100 (Ref. Faro®: 094000100)	Forma: Recta Color: Gris (RAL 7038) Material: Acero
--	--	--

¡ÚLTIMAS UNIDADES!

HASTA AGOTAR



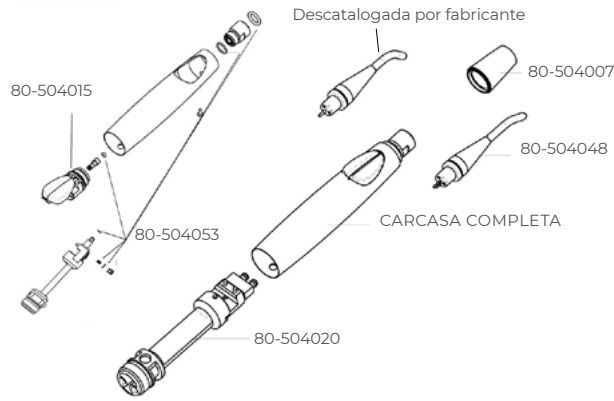

TODOS LOS REPUESTOS FARO® CONSULTE PRECIOS Y DESPIECES

Consulta por las
puntas desechables
Pro-Tip TURBO



Repuestos Jeringas Faro® SYR3



	Descripción	Características
	Cono acero Ref.: 80-504007 (Ref. Faro®: SP094007)	
	Botonera aire/agua jeringa (luds) Ref.: 80-504015 (Ref. Faro®: SP094015 /3)	
	Cuerpo jeringa Ref.: 80-504020 (Ref. Faro®: SP094020)	
	Punta recta gris jeringa Ref.: 80-504048 (Ref. Faro®: SP094048)	
 Imagen no disponible Ver despiece	Kit completo reparación jeringa Ref.: 80-504053 (Ref. Faro®: SP094053)	

Repuestos Jeringas Faro® SM3





	Descripción	Características
	Medios aire/agua Ref.: 80-501291 (Ref. Faro®: SP091291)	

TODOS LOS REPUESTOS FARO® CONSULTE PRECIOS Y DESPIECES

SI NO ENCUENTRAS EL REPUESTO QUE BUSCAS, ¡CONSÚLTANOS!

Jeringas de acero ECO

RUMAR

	Descripción	Características
	<p>Jeringa de acero, 3F angulada (No manguera)*</p> <p>Ref.: 44-280</p>	<p>*Ver manguera 40-6IA2000</p>
	<p>Jeringa de acero, 3F recta (No manguera)*</p> <p>Ref.: 44-281</p>	<p>*Ver manguera 40-6IA2000</p>
	<p>Cánulas de repuesto, esterilizables</p> <p>Ref.: 44-285</p>	

Puntas compatibles jeringas

RUMAR

MÁS BAJO

	Descripción	Características
	<p>Punta para jeringa Cefla® 3F. Compatible</p> <p>Ref.: 44-287 (Ref. Cefla®: 95520612)</p>	<p>Esterilizable 135°C</p>
	<p>Punta para jeringa KaVo® 3F. Compatible</p> <p>Ref.: 44-288 (Ref. KaVo®: 0.773.0011)</p>	<p>Esterilizable 135°C</p>
	<p>Punta para jeringa Sirona® 3F. Compatible</p> <p>Ref.: 44-289 (Ref. Sirona®: 5992206)</p>	<p>Esterilizable 135°C</p>