

JRJ

▶ JERINGAS Y REPUESTOS JERINGAS

- Jeringas **Luzzani**® y sus repuestos
- Jeringas **FARO**® y sus repuestos
- Jeringas económicas
- Puntas compatibles jeringas



RUMAR

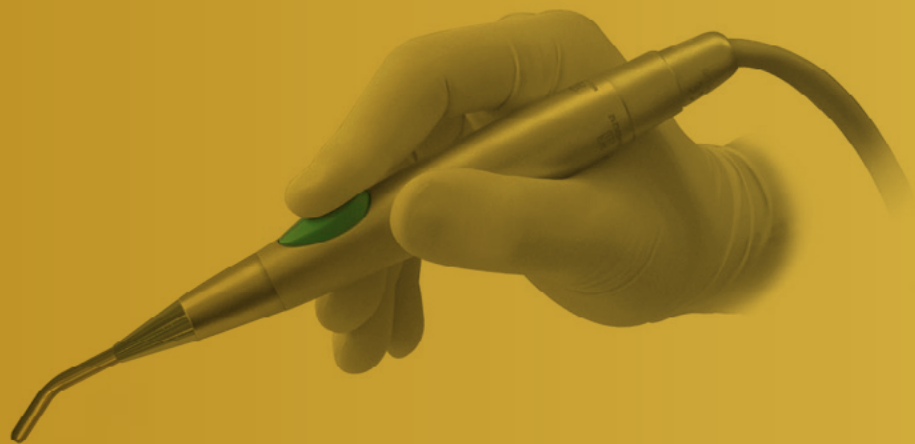
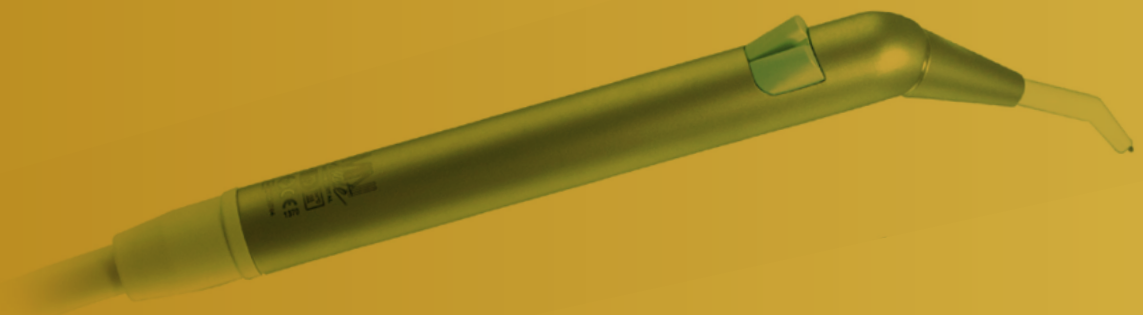
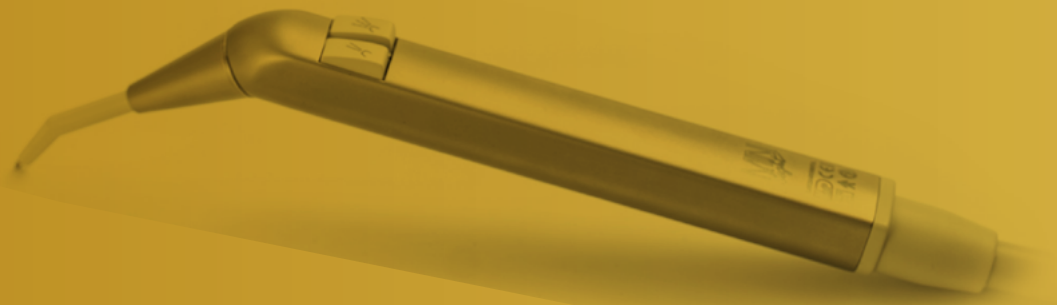
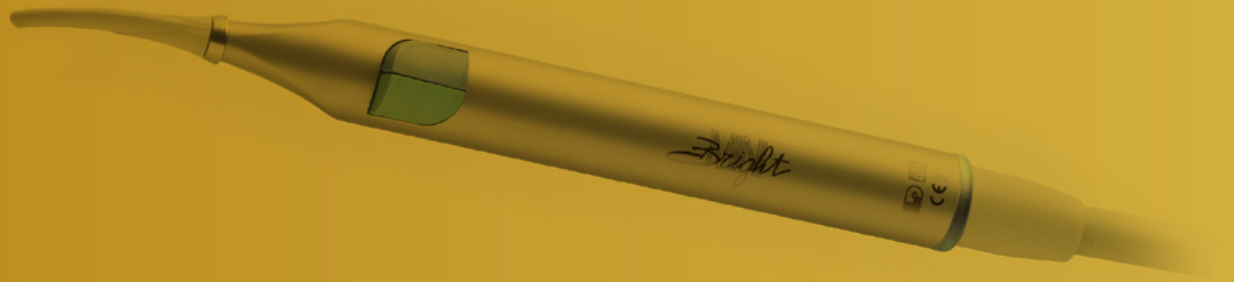

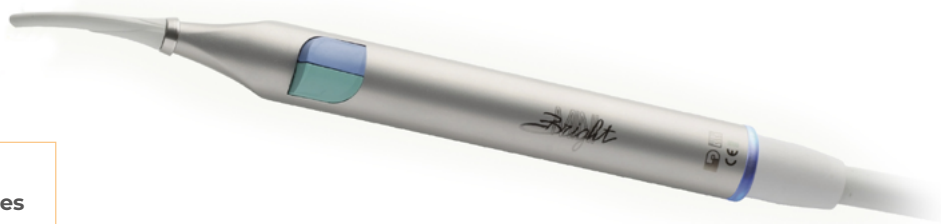

Consulta por las
puntas desechables

Pro-Tip TURBO

Jeringas Luzzani® Minibright



Conexión Abierta / Open End

Jeringa Minibright 6F con luz
Conexión equipo: Abierta

Ref.: **39-3151**

Características





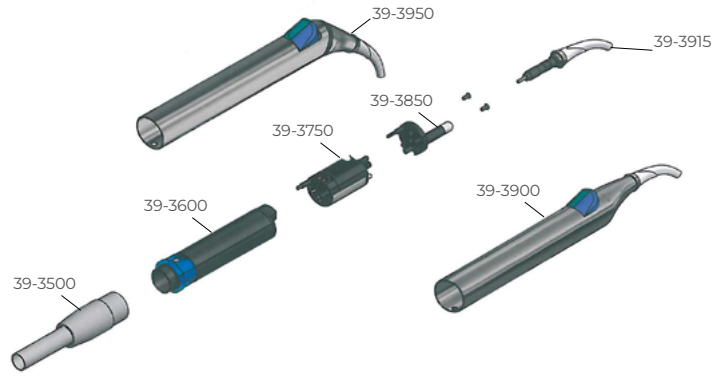

Longitud: 170cm
Forma: Recta
Color: Gris (RAL 7038)
Material: Acero



Consulta por las
puntas desechables
Pro-Tip TURBO

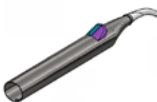

Repuestos Jeringas Minibright: F6 y EFFE 6 BEI

	Descripción	Características
	Punta jeringa Minibright Ref.: 39-3915	
	Kit completo reparación Minibright Ref.: 39-3000	
	Kit completo anillos tóricos Minibright Ref.: 39-3001	
	Cabeza completa Minibright Ref.: 39-3750	
	LED Minibright Ref.: 39-3850	
	Cuerpo central Minibright Ref.: 39-3600	
	Manguera completa Minibright Ref.: 39-3500	Longitud: 170cm Color: Gris (RAL 7038)
	Carcasa completa Minibright Ref.: 39-3900	

TODOS LOS REPUESTOS JERINGAS LUZZANI® CONSULTE PRECIOS Y DESPIECES





SI NO ENCUENTRAS EL REPUESTO QUE BUCAS, ¡CONSÚLTANOS!

Consulta por las
puntas desechables
Pro-Tip TURBO



Jeringas Luzzani® Minilight: Conexión Abierta / Open End



Conexión Abierta / Open End		Características
	Jeringa Minilight 3F. Conexión equipo: Abierta Ref.: 39-12521	Longitud: 170cm Forma: Recta Color: Gris (RAL 7038) Material: Acero
	Jeringa Minilight 3F. Conexión equipo: Abierta Ref.: 39-12621	Longitud: 170cm Forma: Angulada Color: Gris (RAL 7038) Material: Acero
	Jeringa Minilight 6F. Conexión equipo: Abierta Ref.: 39-11521	Longitud: 170cm Forma: Recta Color: Gris (RAL 7038) Material: Acero
	Jeringa Minilight 6F. Conexión equipo: Abierta Ref.: 39-11621	Longitud: 170cm Forma: Angulada Color: Gris (RAL 7038) Material: Acero











Jeringas Luzzani® Minilight: Conector a equipo Cefla® (Desde 2006)



Conector a equipo Cefla® (desde 2006)		Descripción
 	Jeringa Minilight 3F Conexión equipo Cefla® (desde 2006): Anthos®: A3, A5, A6, A7, A9, L6, L9, R7; Stern Weber®: S200, S220TR S250, S280TRC, S300, 320TR, S320TR, S380TRC; Castellini®: SKEMA 5, SKEMA 6, SKEMA 8 Ref.: 39-12521C1	Longitud: 120cm Forma: Recta Color: Gris (RAL 7038) Material: Acero
 	Jeringa Minilight 3F Conexión equipo Cefla® (desde 2006): Anthos®: A3, A5, A6, A7, A9, L6, L9, R7; Stern Weber®: S200, S220TR S250, S280TRC, S300, 320TR, S320TR, S380TRC; Castellini®: SKEMA 5, SKEMA 6, SKEMA 8 Ref.: 39-12521C2	Longitud: 135cm Forma: Recta Color: Gris (RAL 7038) Material: Acero
 	Jeringa Minilight 3F Conexión equipo Cefla® (desde 2006): Anthos®: A3, A5, A6, A7, A9, L6, L9, R7; Stern Weber®: S200, S220TR S250, S280TRC, S300, 320TR, S320TR, S380TRC; Castellini®: SKEMA 5, SKEMA 6, SKEMA 8 Ref.: 39-12621C1	Longitud: 120cm Forma: Angulada Color: Gris (RAL 7038) Material: Acero

TODOS LOS REPUESTOS JERINGAS LUZZANI® CONSULTE PRECIOS Y DESPIECES









Conector a equipo Cefla® (desde 2006)

		Descripción
	 <p>Jeringa Minilight 3F Conexión equipo Cefla® (desde 2006): Anthos®: A3, A5, A6, A7, A9, L6, L9, R7; Stern Weber®: S200, S220TR S250, S280TRC, S300, 320TR, S320TR, S380TRC; Castellini®: SKEMA 5, SKEMA 6, SKEMA 8</p> <p>Ref.: 39-12621C2</p>	<p>Longitud: 135cm Forma: Angulada Color: Gris (RAL 7038) Material: Acero</p>
	 <p>Jeringa Minilight 6F Conexión equipo Cefla® (desde 2006): Anthos®: A3, A5, A6, A7, A9, L6, L9, R7; Stern Weber®: S200, S220TR S250, S280TRC, S300, 320TR, S320TR, S380TRC; Castellini®: SKEMA 5, SKEMA 6, SKEMA 8</p> <p>Ref.: 39-11521C1</p>	<p>Longitud: 120cm Forma: Recta Color: Gris (RAL 7038) Material: Acero</p> <p style="text-align: right;">BAJO PEDIDO</p>
	 <p>Jeringa Minilight 6F Conexión equipo Cefla® (desde 2006): Anthos®: A3, A5, A6, A7, A9, L6, L9, R7; Stern Weber®: S200, S220TR S250, S280TRC, S300, 320TR, S320TR, S380TRC; Castellini®: SKEMA 5, SKEMA 6, SKEMA 8</p> <p>Ref.: 39-11521C2</p>	<p>Longitud: 135cm Forma: Recta Color: Gris (RAL 7038) Material: Acero</p> <p style="text-align: right;">BAJO PEDIDO</p>
	 <p>Jeringa Minilight 6F Conexión equipo Cefla® (desde 2006): Anthos®: A3, A5, A6, A7, A9, L6, L9, R7; Stern Weber®: S200, S220TR S250, S280TRC, S300, 320TR, S320TR, S380TRC; Castellini®: SKEMA 5, SKEMA 6, SKEMA 8</p> <p>Ref.: 39-11621C1</p>	<p>Longitud: 120cm Forma: Angulada Color: Gris (RAL 7038) Material: Acero</p> <p style="text-align: right;">BAJO PEDIDO</p>
	 <p>Jeringa Minilight 6F Conexión equipo Cefla® (desde 2006): Anthos®: A3, A5, A6, A7, A9, L6, L9, R7; Stern Weber®: S200, S220TR S250, S280TRC, S300, 320TR, S320TR, S380TRC; Castellini®: SKEMA 5, SKEMA 6, SKEMA 8</p> <p>Ref.: 39-11621C2</p>	<p>Longitud: 135cm Forma: Angulada Color: Gris (RAL 7038) Material: Acero</p> <p style="text-align: right;">BAJO PEDIDO</p>

Jeringas Luzzani® Minilight: Conector a equipo KaVo®



Conector a equipo KaVo®





















		Descripción
	 <p>Jeringa Minilight 3F Conexión equipo: KaVo® 1057, 1058, 1060, 1062, 1063, 1065, 1066, 1078, 1080 (Series 1) **Excepto** 1058 Primus Life</p> <p>Ref.: 39-12521K1</p>	<p>Longitud: 120cm Forma: Recta Color: Gris (RAL 7038) Material: Acero</p>
	 <p>Jeringa Minilight 3F Conexión equipo: KaVo® 1057, 1058, 1060, 1062, 1063, 1065, 1066, 1078, 1080 (Series 1) **Excepto** 1058 Primus Life</p> <p>Ref.: 39-12521K2</p>	<p>Longitud: 135cm Forma: Recta Color: Gris (RAL 7038) Material: Acero</p>
	 <p>Jeringa Minilight 3F Conexión equipo: KaVo® E30, E50, E70, E80 y 1058 Primus Life (Serie 2)</p> <p>Ref.: 39-12521K3</p>	<p>Longitud: 120cm Forma: Recta Color: Gris (RAL 7038) Material: Acero</p>
	 <p>Jeringa Minilight 3F Conexión equipo: KaVo® E30, E50, E70, E80 y 1058 Primus Life (Serie 2)</p> <p>Ref.: 39-12521K4</p>	<p>Longitud: 135cm Forma: Recta Color: Gris (RAL 7038) Material: Acero</p>

TODOS LOS REPUESTOS JERINGAS LUZZANI® CONSULTE PRECIOS Y DESPIECES

SI NO ENCUENTRAS EL REPUESTO QUE BUSCAS, ¡CONSÚLTANOS!

Conector a equipo KaVo®









Características

		Jeringa Minilight 3F Conexión equipo: KaVo® 1057, 1058, 1060, 1062, 1063, 1065, 1066, 1078, 1080 (Series 1) **Excepto** 1058 Primus Life	Longitud: 120cm Forma: Angulada Color: Gris (RAL 7038) Material: Acero	Ref.: 39-12621K1	
		Jeringa Minilight 3F Conexión equipo: KaVo® 1057, 1058, 1060, 1062, 1063, 1065, 1066, 1078, 1080 (Series 1) **Excepto** 1058 Primus Life	Longitud: 135cm Forma: Angulada Color: Gris (RAL 7038) Material: Acero	Ref.: 39-12621K2	
		Jeringa Minilight 6F Conexión equipo: KaVo® 1057, 1058, 1060, 1062, 1063, 1065, 1066, 1078, 1080 (Series 1) **Excepto** 1058 Primus Life	Longitud: 120cm Forma: Recta Color: Gris (RAL 7038) Material: Acero	Ref.: 39-11521K1	BAJO PEDIDO
		Jeringa Minilight 6F Conexión equipo: KaVo® 1057, 1058, 1060, 1062, 1063, 1065, 1066, 1078, 1080 (Series 1) **Excepto** 1058 Primus Life	Longitud: 135cm Forma: Recta Color: Gris (RAL 7038) Material: Acero	Ref.: 39-11521K2	BAJO PEDIDO
		Jeringa Minilight 6F Conexión equipo: KaVo® 1057, 1058, 1060, 1062, 1063, 1065, 1066, 1078, 1080 (Series 1) **Excepto** 1058 Primus Life	Longitud: 120cm Forma: Angulada Color: Gris (RAL 7038) Material: Acero	Ref.: 39-11621K1	BAJO PEDIDO
		Jeringa Minilight 6F Conexión equipo: KaVo® 1057, 1058, 1060, 1062, 1063, 1065, 1066, 1078, 1080 (Series 1) **Excepto** 1058 Primus Life	Longitud: 135cm Forma: Angulada Color: Gris (RAL 7038) Material: Acero	Ref.: 39-11621K2	BAJO PEDIDO
		Jeringa Minilight 6F Conexión equipo: KaVo®, E30, E50, E70, E80, 1058 Primus Life (Serie 2)	Longitud: 120cm Forma: Recta Color: Gris (RAL 7038) Material: Acero	Ref.: 39-11521K3	BAJO PEDIDO
		Jeringa Minilight 6F Conexión equipo: KaVo®, E30, E50, E70, E80, 1058 Primus Life (Serie 2)	Longitud: 135cm Forma: Recta Color: Gris (RAL 7038) Material: Acero	Ref.: 39-11521K4	BAJO PEDIDO
		Jeringa Minilight 6F Conexión equipo: KaVo®, E30, E50, E70, E80, 1058 Primus Life (Serie 2)	Longitud: 120cm Forma: Angulada Color: Gris (RAL 7038) Material: Acero	Ref.: 39-11621K3	BAJO PEDIDO
		Jeringa Minilight 6F Conexión equipo: KaVo®, E30, E50, E70, E80, 1058 Primus Life (Serie 2)	Longitud: 135cm Forma: Angulada Color: Gris (RAL 7038) Material: Acero	Ref.: 39-11621K4	BAJO PEDIDO

TODOS LOS REPUESTOS JERINGAS LUZZANI® CONSULTE PRECIOS Y DESPIECES

Jeringas Luzzani® Minilight: **Conector a equipo Planmeca®**



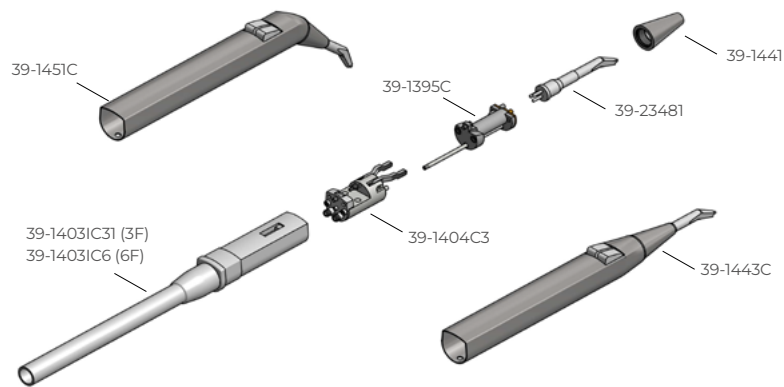

Conector a equipo Planmeca®		Características
  <p>Jeringa Minilight 3F Conexión equipo: Planmeca®</p> <p>Ref.: 39-12521P1</p>	<p>Longitud: 100cm Forma: Recta Color: Gris claro (RAL 9002) Material: Acero Resistencia: 1.780 Ohm</p>	
  <p>Jeringa Minilight 3F Conexión equipo: Planmeca®</p> <p>Ref.: 39-12621P1</p>	<p>Longitud: 100cm Forma: Angulada Color: Gris claro (RAL 9002) Material: Acero Resistencia: 1.780 Ohm</p> <p style="text-align: right;">BAJO PEDIDO</p>	
  <p>Jeringa Minilight 6F Conexión equipo: Planmeca®</p> <p>Ref.: 39-11521P1 (Ref. Planmeca®: 52600287-20)</p>	<p>Longitud: 100cm Forma: Recta Color: Gris claro (RAL9002) Material: Acero Resistencia: 1.780 Ohm</p> <p style="text-align: right;">BAJO PEDIDO</p>	
  <p>Jeringa Minilight 6F Conexión equipo: Planmeca®</p> <p>Ref.: 39-11621P1</p>	<p>Longitud: 100cm Forma: Angulada Color: Gris real (RAL 9002) Material: Acero Resistencia: 1.780 Ohm</p> <p style="text-align: right;">BAJO PEDIDO</p>	



Consulta por las puntas desechables **Pro-Tip TURBO**









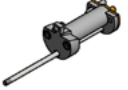

Repuestos Jeringas Minilight



Descripción	Características
 <p>Kit completo reparación</p> <p>Ref.: 39-1000</p>	
 <p>Kit completo 18 anillos tóricos</p> <p>Ref.: 39-1001</p>	

TODOS LOS REPUESTOS JERINGAS LUZZANI® CONSULTE PRECIOS Y DESPIECES

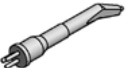
SI NO ENCUENTRAS EL REPUESTO QUE BUSCAS, ¡CONSÚLTANOS!



	Descripción	Características
	<p>Cabeza completa 3F</p> <p>Ref.: 39-1395C</p>	
	<p>Manguera completa jeringa 3F</p> <p>Ref.: 39-14031C31</p>	<p>Longitud: 170cm Color: Gris (RAL 7038) Material jeringa: Acero</p>
	<p>Manguera completa jeringa 6F</p> <p>Ref.: 39-14031C6</p>	<p>Longitud: 170cm Color: Gris (RAL 7038) Material jeringa: Acero</p>
	<p>Cuerpo jeringa 3F (NO 6F)</p> <p>Ref.: 39-1404C3</p>	
 <small>Imagen no disponible</small>	<p>Cuerpo jeringa 6F</p> <p>Ref.: 39-1404</p>	
	<p>Cono Acero</p> <p>Ref.: 39-1441</p>	
	<p>Carcasa completa recta Acero</p> <p>Ref.: 39-1443C</p>	
	<p>Carcasa completa angulada Acero</p> <p>Ref.: 39-1451C</p>	
	<p>Punta gris</p> <p>Ref.: 39-23481</p>	
	<p>Adaptador jeringas Minilight Tecnopolimero a Acero</p> <p>Ref.: 39-1400</p>	

TODOS LOS REPUESTOS JERINGAS LUZZANI® CONSULTE PRECIOS Y DESPIECES

Consulta por las
puntas desechables
Pro-Tip^{TURBO}







Jeringas Luzzani® Minimate: Conexión Abierta / Open End

Conexión Abierta / Open End		Características
	Jeringa Minimate 3F Conexión equipo: Abierta Ref.: 39-251	Longitud: 170cm Forma: Recta Color: Gris (RAL 7038) Material: Acero
	Jeringa Minimate 3F Conexión equipo: Abierta Ref.: 39-261	Longitud: 170cm Forma: Angulada Color: Gris (RAL 7038) Material: Acero

Jeringas Luzzani® Minimate: Conector a equipo Cefla® (desde 2006)



Conector a equipo Cefla® desde 2006		Descripción
 	Jeringa Minimate 3F Conexión equipo Cefla® (desde 2006): Anthos®: A3, A5, A6, A7, A9, L6, L9, R7; Stern Weber®: S200, S220TR S250, S280TRC, S300, 320TR, S320TR, S380TRC; Castellini®: SKEMA 5, SKEMA 6, SKEMA 8 Ref.: 39-251C1	Longitud: 120cm Forma: Recta Color: Gris (RAL 7038) Material: Acero
 	Jeringa Minimate 3F Conexión equipo Cefla® (desde 2006): Anthos®: A3, A5, A6, A7, A9, L6, L9, R7; Stern Weber®: S200, S220TR S250, S280TRC, S300, 320TR, S320TR, S380TRC; Castellini®: SKEMA 5, SKEMA 6, SKEMA 8 Ref.: 39-251C2	Longitud: 135cm Forma: Recta Color: Gris (RAL 7038) Material: Acero
 	Jeringa Minimate 3F Conexión equipo Cefla® (desde 2006): Anthos®: A3, A5, A6, A7, A9, L6, L9, R7; Stern Weber®: S200, S220TR S250, S280TRC, S300, 320TR, S320TR, S380TRC; Castellini®: SKEMA 5, SKEMA 6, SKEMA 8 Ref.: 39-261C1	Longitud: 120cm Forma: Angulada Color: Gris (RAL 7038) Material: Acero
 	Jeringa Minimate 3F Conexión equipo Cefla® (desde 2006): Anthos®: A3, A5, A6, A7, A9, L6, L9, R7; Stern Weber®: S200, S220TR S250, S280TRC, S300, 320TR, S320TR, S380TRC; Castellini®: SKEMA 5, SKEMA 6, SKEMA 8 Ref.: 39-261C2	Longitud: 135cm Forma: Angulada Color: Gris (RAL 7038) Material: Acero















TODOS LOS REPUESTOS JERINGAS LUZZANI® CONSULTE PRECIOS Y DESPIECES

SI NO ENCUENTRAS EL REPUESTO QUE BUSCAS, ¡CONSÚLTANOS!

Jeringas Luzzani® Minimate: **Conector a equipo KaVo®**

Conexión a equipo KaVo®





Características

 	<p>Jeringa Minimate 3F Conexión equipo: KaVo® 1057, 1058, 1060, 1062, 1063, 1065, 1066, 1078, 1080 (Series 1) **Excepto** 1058 Primus Life</p> <p>Ref.: 39-251K1</p>	<p>Longitud: 120cm Forma: Recta Color: Gris (RAL 7038) Material: Acero</p>
 	<p>Jeringa Minimate 3F Conexión equipo: KaVo® 1057, 1058, 1060, 1062, 1063, 1065, 1066, 1078, 1080 (Series 1) **Excepto** 1058 Primus Life</p> <p>Ref.: 39-251K2</p>	<p>Longitud: 135cm Forma: Recta Color: Gris (RAL 7038) Material: Acero</p>
 	<p>Jeringa Minimate 3F Conexión equipo: KaVo®, E30, E50, E70, E80, 1058 Primus Life (Serie 2)</p> <p>Ref.: 39-251K3</p>	<p>Longitud: 120cm Forma: Recta Color: Gris (RAL 7038) Material: Acero</p>
 	<p>Jeringa Minimate 3F Conexión equipo: KaVo®, E30, E50, E70, E80, 1058 Primus Life (Serie 2)</p> <p>Ref.: 39-251K4</p>	<p>Longitud: 135cm Forma: Recta Color: Gris (RAL 7038) Material: Acero</p> <p style="text-align: right;">BAJO PEDIDO</p>
 	<p>Jeringa Minimate 3F Conexión equipo: KaVo® 1057, 1058, 1060, 1062, 1063, 1065, 1066, 1078, 1080 (Series 1) **Excepto** 1058 Primus Life</p> <p>Ref.: 39-261K1</p>	<p>Longitud: 120cm Forma: Angulada Color: Gris (RAL 7038) Material: Acero</p>
 	<p>Jeringa Minimate 3F Conexión equipo: KaVo® 1057, 1058, 1060, 1062, 1063, 1065, 1066, 1078, 1080 (Series 1) **Excepto** 1058 Primus Life</p> <p>Ref.: 39-261K2</p>	<p>Longitud: 135cm Forma: Angulada Color: Gris (RAL 7038) Material: Acero</p>
 	<p>Jeringa Minimate 3F Conexión equipo: KaVo®, E30, E50, E70, E80, 1058 Primus Life (Serie 2)</p> <p>Ref.: 39-261K3</p>	<p>Longitud: 120cm Forma: Angulada Color: Gris (RAL 7038) Material: Acero</p>

Jeringas Luzzani® Minimate: **Conector a equipo Planmeca®**

Conexión a equipo Planmeca®

Descripción

 	<p>Jeringa Minimate 3F Conexión equipo: Planmeca®</p> <p>Ref.: 39-251P1</p>	<p>Longitud: 100cm Forma: Recta Color: Gris real (RAL 9002) Material: Acero Resistencia: 1.780 Ohm</p>
 	<p>Jeringa Minimate 3F Conexión equipo: Planmeca®</p> <p>Ref.: 39-261P1</p>	<p>Longitud: 100cm Forma: Angulada Color: Gris real (RAL 9002) Material: Acero Resistencia: 1.780 Ohm</p> <p style="text-align: right;">BAJO PEDIDO</p>





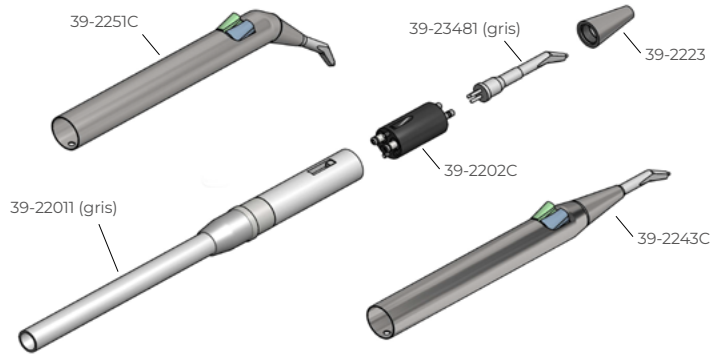

TODOS LOS REPUESTOS JERINGAS LUZZANI® CONSULTE PRECIOS Y DESPIECES

Consulta por las
puntas desechables
Pro-Tip^{TURBO}



Repuestos Jeringas Minimate

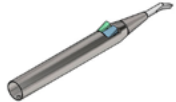
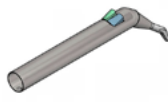

	Descripción	Características
	Kit completo reparación Ref.: 39-2000	
	Manguera completa para jeringa 3F Ref.: 39-22011	Longitud: 170cm Color: Gris (RAL 7038) Material jeringa: Acero
	Cuerpo jeringa 3F Ref.: 39-2202C	
	Cono Acero Origen: Italia Fabricante: Luzzani® Dental S.R.L. Garantía: 12 meses Ref.: 39-2223	
	Carcasa completa recta Acero Ref.: 39-2243C	Forma: Recta Material: Acero
	Carcasa completa angulada Acero Ref.: 39-2251C	Forma: Angulada Material: Acero
	Punta gris Ref.: 39-23481	

TODOS LOS REPUESTOS JERINGAS LUZZANI® CONSULTE PRECIOS Y DESPIECES

SI NO ENCUENTRAS EL REPUESTO QUE BUCAS, ¡CONSÚLTANOS!

Consulta por las
puntas desechables
Pro-Tip[®]TURBO

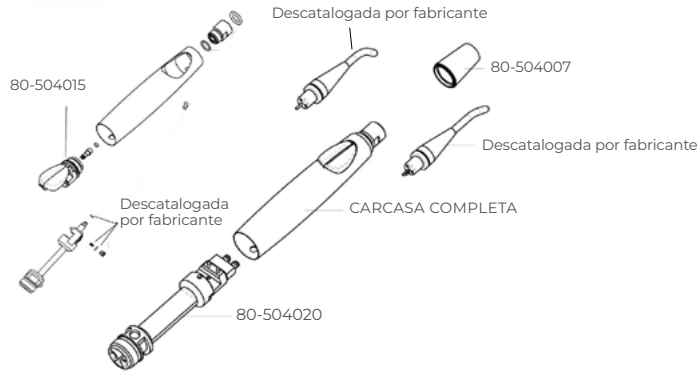

Repuestos Jeringas Faro[®] SYR3



	Descripción	Características
	Cono acero Ref.: 80-504007 (Ref. Faro [®] : SP094007)	HASTA AGOTAR
	Botonera aire/agua jeringa (luds) Ref.: 80-504015 (Ref. Faro [®] : SP094015 /3)	HASTA AGOTAR



Repuestos Jeringas Faro[®] SM3



	Descripción	Características
	Medios aire/agua Ref.: 80-501291 (Ref. Faro [®] : SP091291)	HASTA AGOTAR

Jeringas de acero ECO



	Descripción	Características
	Jeringa de acero, 3F angulada (No manguera)* Ref.: 44-280	*Ver manguera 40-61A2000
	Jeringa de acero, 3F recta (No manguera)* Ref.: 44-281	*Ver manguera 40-61A2000
	Cánulas de repuesto, esterilizables Ref.: 44-285	

TODOS LOS REPUESTOS FARO[®] CONSULTE PRECIOS Y DESPIECES

Puntas compatibles jeringas

	Descripción	Características
	Punta para jeringa Cefla® 3F . Compatible Ref.: 44-287 (Ref. Cefla®: 95520612)	Esterilizable 135°C
	Punta para jeringa KaVo® 3F . Compatible Ref.: 44-288 (Ref. KaVo®: 0.773.0011)	Esterilizable 135°C
	Punta para jeringa Sirona® 3F . Compatible Ref.: 44-289 (Ref. Sirona®: 5992206)	Esterilizable 135°C

TODOS LOS REPUESTOS FARO® CONSULTE PRECIOS Y DESPIECES

SI NO ENCUENTRAS EL REPUESTO QUE BUCAS, ¡CONSÚLTANOS!